Systems and Freestanding Furniture

Volume 1c

Terms and Conditions	A2
Sample Order Form	A8
Participating Steelcase Dealers	A10
Steelcase Showrooms and Manufacturing Locations	A15
Flammability Ratings for Steelcase Panel Systems	A16

Product Information	
Answer (SIN 711.1)	B1
Montage (SIN 711.1)	C1
Universal Worksurface Products (SIN 711.1)	D1

Resources	
Style Number Index	E2

► For a list of all trademarks, refer to the last page of this specification guide.

Terms and Conditions

Customer Information

For more information, please contact your participating Steelcase GSA dealer.

For more information, please contact your participating Steelcase GSA dealer.

For more information, please contact your participating Steelcase GSA dealer.

For more information, please contact your participating Steelcase GSA dealer.

For more information, please contact your participating Steelcase GSA dealer.

For more information, please contact your participating Steelcase GSA dealer.

Sample Order Form

Sample Order Form

ORDER FOR SUPPLIES OR SERVICES	PAGE _____ OF _____ PAGES
---------------------------------------	---------------------------

IMPORTANT: Mark all packages and papers with contract and/or order numbers.

DATE OF ORDER 1 6-1-04	CONTRACT NO. (If any) 2 GS-28F-8021H	ORDER NO. 3 10 - 000	REQUISITION/REFERENCE NO.
ISSUING OFFICE (Address correspondence to) 4 GSA 1 Town Street City, State, Zip Name and Telephone Number		SHIP TO: (Consignee and address, ZIP Code) 5 GSA 2 Town Street City, State, Zip Name and Telephone Number	
TO: CONTRACTOR (Name, address and ZIP Code) 6 Steelcase Inc. c/o Participating Dealer 901 44th Street, SE Grand Rapids, MI 49508 Attn: Major Account Services CH-2W-SS (GSA)		Cage Code: 39880	TYPE OF ORDER <input type="checkbox"/> A. PURCHASE — Reference your _____ Please furnish the following on the terms and conditions specified on both sides of this order and on the attached sheets, if any, including delivery as indicated. This purchase is negotiated under authority of: <input type="checkbox"/> B. DELIVERY — Except for billing instructions on the reverse, this delivery order is subject to instructions contained on this side only of this form and is issued subject to the terms and conditions of the above-numbered contract.

ACCOUNTING AND APPROPRIATION DATA	REQUISITIONING OFFICE		
	BUSINESS CLASSIFICATION (Check appropriate box(es)) 20 <input type="checkbox"/> SMALL <input checked="" type="checkbox"/> OTHER THAN SMALL <input type="checkbox"/> DIS-ADVANTAGED <input type="checkbox"/> WOMEN-OWNED		
FCA DESTINATION 7	GOVERNMENT NO.	DELIVER TO FCA DESTINATION ON OR BEFORE (Date) 8 ARO date	DISCOUNT TERMS 9 Net 30 days
PLACE OF INSPECTION AND ACCEPTANCE			

(See reverse for Rejections)

ITEM NO. (A)	SUPPLIES OR SERVICES (B)	QUANTITY ORDERED (C)	UNIT (D)	UNIT PRICE (E)	AMOUNT (F)	QUANTITY ACCEPTED (G)
1	10 One lot of Steelcase Office Furniture: See attached specifications	13 1		14 \$000	15 \$000	
2	11 Design: \$55.36/hour	2 hrs		\$000	\$000	
3	12 Installation	1		\$000	\$000	
<i>SEE BILLING INSTRUCTIONS ON REVERSE</i>	SHIPPING POINT	GROSS SHIPPING WEIGHT	INVOICE NO.			(H) TOT. ◀ (Cont. pages)
	MAIL INVOICE TO: (Include ZIP Code) 17 GSA, 3 Town Street, City, State, Zip			16	\$000	(I) GRAND TOTAL ◀

UNITED STATES OF AMERICA BY (Signature) 18 Contracting Officer signature and telephone no.	NAME (Typed) 19 John Doe, Department Manager TITLE: CONTRACTING/ORDERING OFFICER
--	---

- 1 Order date
- 2 Contract number
- 3 Order number
- 4 Issuing office: Requestor name and telephone number
- 5 Shipping address: Contact name and telephone number
- 6 Contractor:
Steelcase Inc.
c/o Participating Dealer
901 - 44th Street, S.E.
Grand Rapids, MI 49508
Attn: Major Account Services CH-2W-SS (GSA)
- 7 FCA destination
- 8 ARO date (After Receipt of Order)
- 9 Terms: Net 30 days
- 10 Complete product description, including SIN number, style number, all applicable surface materials.
- 11 Separate line for design
- 12 Separate line for installation
- 13 Quantity ordered
- 14 Individual unit price
- 15 Amount (quantity x unit price)
- 16 Total cost
- 17 Invoice address
- 18 Authorized contracting officer signature and telephone number
- 19 Authorized contracting officer name and title (typed)
- 20 Steelcase is the seller of record and is not registered as "small," "disadvantaged," or "woman-owned." If one of these boxes is checked in error, a modification will be required.

Please note on order that all invoice payments must be sent to:

Steelcase Inc.
P.O. Box 99315
Chicago, IL 60693

Participating Steelcase Dealers

Alabama

Bodine Inc.
2141 14th Avenue South
Birmingham, AL 35205-3921
Phone: (205) 933-9100
Fax: (205) 933-8607

Hudson Office Supply Inc.
2401 North Range
Dothan, AL 36303-5865
Phone: (334) 792-3155
Fax: (334) 793-2761

Ivan Allen Workspace
Suite 102
200 Westside Square
Huntsville, AL 35801
Phone: (256) 551-2728
Fax: (256) 551-2748

Kyser OfficeWorks Inc.
2400 Spruce Street
Montgomery, AL 36107-3150
Phone: (334) 834-9400
Fax: (334) 262-0701

OEC Business Interiors
104 East I-65 Service Road North
Mobile, AL 36607-2501
Phone: (251) 471-3368
Fax: (251) 471-0019

OSCO Inc.
229 Grant Street SE
Decatur, AL 35601-2511
Phone: (256) 340-5100
Fax: (256) 340-5108

Alaska

Capital Office Systems
1120 East 35th Avenue
Anchorage, AK 99508-4257
Phone: (907) 777-1500
Fax: (907) 777-1515

Capital Office Systems
5312 Commercial Blvd.
Juneau, AK 99801-7214
Phone: (907) 586-2830
Fax: (907) 780-2290

Arizona

Walsh Brothers Office
Environments
1636 North Central Avenue
Phoenix, AZ 85004-1623
Phone: (602) 252-6971
Fax: (602) 252-8222

Walsh Brothers Office
Environments Inc.
1201 East Broadway Blvd.
Tucson, AZ 85719-5822
Phone: (520) 792-4200
Fax: (520) 791-9568

Arkansas

Today's Office Inc.
717 West 7th Street
Little Rock, AR 72201-4044
Phone: (501) 375-5050
Fax: (501) 375-1350

California

BKM Office Environments
Suite A
2111 Portola Road
Ventura, CA 93003-7723
Phone: (805) 339-6388
Fax: (805) 336-9131

BKM San Diego
Suite A
9650 Chesapeake Drive
San Diego, CA 92123-1386
Phone: (858) 569-4700
Fax: (858) 277-8931

One Workplace L. Ferrari
1057 Montague Expressway
Milpitas, CA 95035-6818
Phone: (408) 263-1001
Fax: (408) 719-5700

One Workplace L. Ferrari
475 Brannan Street
San Francisco, CA 94107-1731
Phone: (415) 357-2200
Fax: (415) 357-2201

Peninsula Business Interiors
325 Main Street
Salinas, CA 93901-2705
Phone: (831) 757-4107
Fax: (831) 757-1339

Peninsula Business Interiors LLC
Suite 102
4057 West Shaw Avenue
Fresno, CA 93722-6212
Phone: (559) 275-4111
Fax: (559) 275-0101

Tangram Interiors
2850 South Red Hill Avenue
Santa Ana, CA 92705
Phone: (949) 955-6700
Fax: (949) 955-6799

Tangram Interiors
9200 Sorensen Avenue
Santa Fe Springs, CA 90670-2645
Phone: (562) 365-5000
Fax: (562) 777-9742

United Corporate Furnishings
1780 North Market Blvd.
Sacramento, CA 95834
Phone: (916) 553-5900
Fax: (916) 553-5800

Colorado

Office Outfitters & Planners Inc.
749 Main Street
Grand Junction, CO 81501-3535
Phone: (970) 245-6300
Fax: (970) 245-6301

OfficeScapes
272 South Academy Blvd
Colorado Springs, CO 80910-2714
Phone: (719) 574-1113
Fax: (719) 574-1133

OfficeScapes
9900 East 51st Avenue
Denver, CO 80238-2430
Phone: (303) 574-1115
Fax: (303) 574-1116

OfficeScapes
Suite 180
4812 McMurry Avenue
Fort Collins, CO 80525-6222
Phone: (970) 223-5959
Fax: (970) 223-5858

Delaware

Corporate Interiors Inc.
223 Lisa Drive
New Castle, DE 19720-4193
Phone: (302) 323-9100
Fax: (302) 323-9251

Florida

American Business Interiors
2015 Waverly Place
Melbourne, FL 32901-5444
Phone: (321) 723-5003
Fax: (321) 984-4221

Capital Business Interiors Inc.
132-1 Hamilton Park Drive
Tallahassee, FL 32304
Phone: (850) 383-4225
Fax: (850) 383-7555

Interior Design Services Inc.
1618 Main Street
Sarasota, FL 34236-5811
Phone: (941) 954-0791
Fax: (941) 953-3299

Interior Design Services Inc.
Suite 100
11200 9th Street North
St. Petersburg, FL 33716-2349
Phone: (727) 576-7055
Fax: (813) 222-0972

Leitz & Reed Office Products
2116 South Highway 77
Lynn Haven, FL 32444-4622
Phone: (850) 271-2600
Fax: (850) 271-0076

OEC Business Interiors
1601 NW 80th Boulevard
Gainesville, FL 32606-9140
Phone: (352) 332-1192
Fax: (352) 333-8002

OEC Business Interiors
2393 SW College Road
Ocala, FL 34474
Phone: (352) 620-2888
Fax: (352) 620-2891

OEC Business Interiors
3914 North Davis Highway
Pensacola, FL 32503-2746
Phone: (850) 438-1100
Fax: (850) 432-0003

Office Furniture & Design Concepts
2323 Cleveland Avenue
Ft. Myers, FL 33901-3541
Phone: (239) 337-1212
Fax: (239) 337-4910

Office Interiors of Florida
Suite 1
10800 NW 103rd Street
Miami, FL 33178-1049
Phone: (305) 887-4881
Fax: (305) 885-1930

Perdue Office Interiors
8443 Baymeadows Road
Jacksonville, FL 32256-7440
Phone: (904) 737-5858
Fax: (904) 737-6088

Thomas W. Ruff & Company -
Miami
3201 Commerce Parkway
Miramar, FL 33025-3908
Phone: (954) 435-7300
Fax: (954) 435-7212

Thomas W. Ruff & Company -
Orlando
911 South Orlando Avenue
Maitland, FL 32751-6407
Phone: (407) 628-2400
Fax: (407) 628-8941

Thomas W. Ruff & Company - Palm
Beach
Suite 2
7830 Byron Drive
West Palm Beach, FL 33404-3332
Phone: (561) 840-8600
Fax: (561) 840-1873

Georgia

Commercial Furnishings
112 West Macon Park Drive
Macon, GA 31210-6812
Phone: (478) 757-9190
Fax: (478) 757-9806

DeKalb Office Environments
1320 Ridgeland Parkway
Alpharetta, GA 30004
Phone: (770) 360-0200
Fax: (770) 360-0305

Ivan Allen Workspace
Suite 3
2925 Ledo Road
Albany, GA 31707-1267
Phone: (229) 439-7418
Fax: (229) 435-1279

Ivan Allen Workspace
Suite 200
730 Peachtree Street NE
Atlanta, GA 30308-1210
Phone: (404) 760-8700
Fax: (404) 760-8673

Ivan Allen Workspace
Suite E
3021 River Watch Pkwy
Augusta, GA 30907-3246
Phone: (706) 863-4828
Fax: (706) 228-4987

Lee Office Equipment Company
201 West Hill Avenue
Valdosta, GA 31601-5692
Phone: (229) 244-0177
Fax: (229) 247-3406

McWaters Inc.
117 Prosperity Drive
Garden City, GA 31408-9551
Phone: (912) 352-9000
Fax: (912) 352-2034

Hawaii

Interior Showplace Ltd.
956 Queen Street
Honolulu, HI 96814-4118
Phone: (808) 593-8420
Fax: (808) 591-8324

Idaho

Bangs Office Products Inc.
435 West Center Street
Pocatello, ID 83204-3241
Phone: (208) 232-1233
Fax: (208) 232-8759

Office Environment Company
1605 Fairview Avenue
Boise, ID 83702-5120
Phone: (208) 385-0507
Fax: (208) 385-9392

Illinois

Egyptian Business Furniture
129 West Main Street
Belleville, IL 62220-1501
Phone: (618) 234-2323
Fax: (618) 236-3295

Environetx
1351 East Irving Park Road
Itasca, IL 60143-2300
Phone: (630) 875-3700
Fax: (630) 875-3701

Environetx
Suite 106 & 107
1111 Burlington Avenue
Lisle, IL 60532-1703
Phone: (630) 875-3700
Fax: (630) 434-8126

Johnson & Associates Business
Interiors
4 NW
223 West Erie Street
Chicago, IL 60610
Phone: (312) 649-0074
Fax: (312) 649-0342

Lincoln Office
Unit 2C
202 South Eldorado Road
Bloomington, IL 61704-4482
Phone: (309) 663-1835
Fax: (309) 662-4211

Lincoln Office
Suite E-1
1906 Fox Drive
Champaign, IL 61820-7338
Phone: (217) 363-3901
Fax: (217) 363-3902

Lincoln Office
4575 16th Street
Moline, IL 61265-7013
Phone: (309) 736-0101
Fax: (309) 736-0202

Lincoln Office
7707 North Knoxville Avenue
Peoria, IL 61614-2014
Phone: (309) 693-2444
Fax: (309) 692-1018

Lincoln Office
681 East Linton Avenue
Springfield, IL 62703-5902
Phone: (217) 541-1000
Fax: (217) 541-1001

Office Concepts
965 West Chicago Avenue
Chicago, IL 60622-5413
Phone: (312) 942-1100
Fax: (312) 942-9840

Office Concepts
13820 West Business Center Drive
Lake Forest, IL 60045-1181
Phone: (847) 573-8890
Fax: (847) 573-8891

Office Equipment Company of
Chicago
900 North Church Road
Elmhurst, IL 60126-1014
Phone: (630) 589-5500
Fax: (630) 589-5637

Indiana

Business Furniture Corp.
6102 Victory Way
Indianapolis, IN 46278-2934
Phone: (317) 216-1600
Fax: (317) 216-1602

Corporate Design Inc.
Suite A
1419 West Lloyd Expressway
Evansville, IN 47710-1002
Phone: (812) 422-3000
Fax: (812) 422-3413

Lincoln Office
1200 Arrowhead Court
Crown Point, IN 46307-8222
Phone: (219) 662-2777
Fax: (219) 662-7770

Iowa

Frohwein Contract Interiors
Highway 6 West
218 Second Street
Coralville, IA 52241-2608
Phone: (319) 338-3135
Fax: (319) 338-7484

Officelements LLC
713 Nebraska Street
Sioux City, IA 51101-1103
Phone: (712) 255-0181
Fax: (712) 255-0203

Pioneer Workspace Solutions
1239 First Avenue S.E.
Cedar Rapids, IA 52402-5007
Phone: (319) 364-8148
Fax: (319) 364-1882

Workspace Inc.
309 Locust Street
Des Moines, IA 50309-1788
Phone: (515) 288-7090
Fax: (515) 288-0250

Kansas

Scott Rice Office Interiors
1425 East Douglas Avenue
Wichita, KS 67211-1640
Phone: (316) 269-2700
Fax: (316) 269-3527

Scott Rice Office Works
14720 West 105th Street
Lenexa, KS 66215-4414
Phone: (913) 888-7600
Fax: (913) 227-7793

Kentucky

Cardinal Office Systems
400 East Main Street
Bowling Green, KY 42101-2241
Phone: (270) 781-5858
Fax: (270) 781-5884

Cardinal Office Systems
576 East Main Street
Frankfort, KY 40601-2343
Phone: (502) 875-3300
Fax: (502) 875-2782

Cardinal Office Systems
101 Bradley Drive
Nicholasville, KY 40356-9121
Phone: (859) 885-6161
Fax: (859) 885-9610

Office Resources Inc.
816 East Broadway
Louisville, KY 40204-1053
Phone: (502) 589-8400
Fax: (502) 589-8408

Louisiana

A.D. Wynne Company Inc.
710 Baronne Street
New Orleans, LA 70113-1062
Phone: (504) 522-9558
Fax: (504) 522-7070

Bath Business Services
610 Market Street
Shreveport, LA 71101-3643
Phone: (318) 221-7141
Fax: (318) 425-7117

General Office Supply Company
1003 Jefferson Street
Lafayette, LA 70501-7915
Phone: (337) 237-2563
Fax: (337) 234-2287

Maine

Office Environments of New
England
2 City Center
Portland, ME 04101-4010
Phone: (207) 774-4900
Fax: (207) 774-8155

Participating Steelcase Dealers, continued

Maryland

Arbee Associates
111 Market Place
Baltimore, MD 21202-4035
Phone: (410) 385-5180
Fax: (410) 385-5199

Arbee Associates
950 Wind River Lane
Gaithersburg, MD 20878-1974
Phone: (301) 963-3900
Fax: (301) 977-1734

Office Suppliers Inc.
13716 Crayton Blvd.
Hagerstown, MD 21742-2335
Phone: (301) 797-3120
Fax: (301) 797-1407

US Business Interiors Inc.
575 South Charles Street
Baltimore, MD 21201-2428
Phone: (410) 547-8700
Fax: (410) 547-6677

US Business Interiors Inc.
8800 Lottsford Road
Largo, MD 20774
Phone: (301) 350-8700
Fax: (301) 350-9393

Massachusetts

Office Environments of New
England
280 Summer Street
Boston, MA 02210-1131
Phone: (617) 439-4900
Fax: (617) 439-4131

Office Environments of New
England
810 Boston Turnpike
Shrewsbury, MA 1545
Phone: (508) 842-3000
Fax: (508) 842-2723

Workplace Solutions
59 Interstate Drive
West Springfield, MA 01089-5100
Phone: (413) 736-1802
Fax: (413) 736-6145

Michigan

Allied Office Interiors Inc.
701 Salzburg Avenue
Bay City, MI 48706-5390
Phone: (989) 895-8574
Fax: (989) 895-8545

Allied Office Interiors Inc.
Suite 17
8185 Holly Road
Grand Blanc, MI 48439-2444
Phone: (810) 953-7100
Fax: (810) 953-6146

Allied Office Interiors Inc.
5133 West Grand River Avenue
Lansing, MI 48906-9117
Phone: (517) 886-0072
Fax: (517) 886-0014

Custer Office Environments Inc.
45 Ottawa Ave NW
Grand Rapids, MI 49503-2602
Phone: (616) 458-6322
Fax: (616) 458-1117

Custer Office Environments Inc.
5200 South Sprinkle Road
Kalamazoo, MI 49002-2055
Phone: (269) 342-3919
Fax: (269) 342-3923

WorkPlace Integrators
Suite 4700
30800 Telegraph Road
Bingham Farms, MI 48025-4536
Phone: (248) 430-2345
Fax: (248) 430-2346

Minnesota

General Office Products Company
4521 Highway 7
Minneapolis, MN 55416-4098
Phone: (952) 925-7500
Fax: (952) 925-7531

Mississippi

Barefield & Company
251 West South Street
Jackson, MS 39203-3636
Phone: (601) 354-4960
Fax: (601) 353-6231

OEC Business Interiors
525 Pass Road
Gulfport, MS 39507-2906
Phone: (228) 868-1040
Fax: (228) 864-0040

Missouri

Color-Art Integrated Interiors
1325 North Warson Road
Saint Louis, MO 63132-1807
Phone: (314) 432-3000
Fax: (314) 993-2752

Marathon Office Interiors
1725 Paris Road
Columbia, MO 65201-5571
Phone: (573) 875-7115
Fax: (573) 875-7116

Scheffer's Office Furn & Business
Machines
Unit B
320 South Plaza Way
Cape Girardeau, MO 63703-5854
Phone: (573) 472-2422
Fax: (573) 472-1293

Scheffer's Office Furn & Business
Machines
1558 State Highway H
3 Miles North on H Highway
Sikeston, MO 63801-9420
Phone: (573) 472-2422
Fax: (573) 472-1293

Montana

Capital Office Equipment & Design
Inc.
648 North Jackson Street
Helena, MT 59601-3629
Phone: (406) 442-3480
Fax: (406) 442-3419

Missoula's Office City
115 West Broadway Street
Missoula, MT 59802-4217
Phone: (406) 543-7171
Fax: (406) 543-4254

Peterson's Quality Office
Equipment
502 North 32nd Street
Billings, MT 59101-6003
Phone: (406) 245-5151
Fax: (406) 245-7516

Western Office Equipment
317 2nd Street South
Great Falls, MT 59405-1802
Phone: (406) 761-7473
Fax: (406) 761-0245

Nebraska

Eakes Office Plus
2911 13th Street
Columbus, NE 68601-4829
Phone: (402) 564-2679
Fax: (402) 564-0295

Eakes Office Plus
617 West Third Street
Grand Island, NE 68801-5946
Phone: (308) 382-8026
Fax: (308) 382-7401

Eakes Office Plus
839 West Second Street
Hastings, NE 68901-5099
Phone: (402) 463-2537
Fax: (402) 463-6802

Eakes Office Plus
2401 Avenue A
Kearney, NE 68847-5498
Phone: (308) 234-2538
Fax: (308) 234-2540

Eakes Office Plus
520 North Vine Street
North Platte, NE 69101-3954
Phone: (308) 534-7800
Fax: (308) 534-3936

Sheppard's Business Interiors Inc.
Suite 431
140 North 8th Street
Lincoln, NE 68508-1351
Phone: (402) 441-0070
Fax: (402) 476-9710

Sheppard's Business Interiors Inc.
725 South 72nd Street
Omaha, NE 68114-4665
Phone: (402) 393-8888
Fax: (402) 393-0113

Nevada

Machabee Office Environments
6435 Sunset Corporate Drive
Las Vegas, NV 89120-2798
Phone: (702) 263-8800
Fax: (702) 263-8801

Machabee Office Environments
130 South Center Street
Reno, NV 89501-1539
Phone: (775) 329-3145
Fax: (775) 786-5710

New Jersey

Arbee Associates
2 Stahuber Avenue
Union, NJ 07083-5023
Phone: (908) 686-3900
Fax: (908) 686-6034

General Office Environments
18 Railroad Avenue
Rochelle Park, NJ 07662-4101
Phone: (201) 845-0010
Fax: (201) 845-0034

General Office Environments
65 Clyde Road
Somerset, NJ 08873-3485
Phone: (732) 873-6900
Fax: (732) 873-3357

W.S. Goff Company Inc.
400 South Main Street
Pleasantville, NJ 08232-3032
Phone: (609) 641-4165
Fax: (609) 641-1690

New Mexico

Business Environments
4121 Prospect Avenue, N.E.
Albuquerque, NM 87110-3817
Phone: (505) 888-4400
Fax: (505) 889-9146

New York

AFD Contract Furniture Inc.
88 West End Avenue
New York, NY 10023-6301
Phone: (212) 721-7100
Fax: (212) 721-7175

Business Environments by Ras Inc.
161 River Street
Troy, NY 12180-3807
Phone: (518) 458-7922
Fax: (518) 458-7463

Hudson Bay Environments
One Fordham Plaza
New York, NY 10458-5871
Phone: (718) 933-3000
Fax: (718) 933-3033

Merkel-Donohue
1 Woodbury Boulevard
Rochester, NY 14604-1895
Phone: (585) 325-7696
Fax: (585) 325-3065

Prentice Office Environments
472 Franklin Street
Buffalo, NY 14202-1302
Phone: (716) 884-8452
Fax: (716) 884-0894

Stevens Office Interiors
1449 Erie Boulevard East
Syracuse, NY 13210-1250
Phone: (315) 479-5595
Fax: (315) 428-1688

Waldner's Business Environments
125 Route 110
Farmingdale, NY 11735-4864
Phone: (631) 844-9300
Fax: (631) 694-3503

Waldner's Business Environments
215 Lexington Avenue, 9th Floor
New York, NY 10016-6023
Phone: (212) 696-7500
Fax: (212) 696-7699

Waldner's Business Environments
401 Theodore Fremd Avenue
Rye, NY 10580-1422
Phone: (914) 921-1500
Fax: (914) 921-0991

North Carolina

Benton Office Products Inc.
301 Nash Street West
Wilson, NC 27893-3834
Phone: (252) 237-6176
Fax: (252) 237-9316

Contract Office Furnishings Inc.
1023 West 14th Street
Winston-Salem, NC 27105-5811
Phone: (336) 724-6912
Fax: (336) 722-2704

Office Environments Inc.
11415 Granite Street
Charlotte, NC 28273-6429
Phone: (704) 714-7200
Fax: (704) 714-7400

Office Environments of Asheville Inc.
1070 Tunnel Road
Asheville, NC 28805-2014
Phone: (828) 299-3300
Fax: (828) 299-3046

Storr Office Environments Inc.
496 Gallimore Dairy Road, Suite A
Greensboro, NC 27409-9202
Phone: (336) 217-4500
Fax: (336) 217-4501

Storr Office Environments Inc.
10800 World Trade Blvd.
Raleigh, NC 27617
Phone: (919) 313-3700
Fax: (919) 313-3701

Williams Office Environments Inc.
407 Ray Avenue
Fayetteville, NC 28301-4915
Phone: (910) 483-0354
Fax: (910) 486-4077

North Dakota

Fireside Office Products Inc.
1713 East Bismarck Expressway
Bismarck, ND 58504-6706
Phone: (701) 258-8586
Fax: (701) 223-9598

Gaffaney's of Grand Forks
1809 13th Avenue North
Grand Forks, ND 58203-2323
Phone: (701) 746-6466
Fax: (701) 746-0737

Hannaher's Inc.
4324 20th Avenue SW
 Fargo, ND 58103-4434
Phone: (701) 277-7222
Fax: (701) 277-7097

Professional Business Interiors Inc.
Suite 3
710 31st Avenue SW
Minot, ND 58701-7033
Phone: (701) 837-4848
Fax: (701) 837-4865

Ohio

Everybody's Inc.
5225 Springboro Pike
Dayton, OH 45439-2970
Phone: (937) 293-1010
Fax: (937) 293-7501

Loth Mbi Inc.
3574 East Kemper Road
Cincinnati, OH 45241-2009
Phone: (513) 554-4900
Fax: (513) 554-8737

Ohio Desk Company
1122 Prospect Avenue E
Cleveland, OH 44115-1292
Phone: (216) 623-0600
Fax: (216) 623-0611

Thomas W. Ruff & Company
1114 Dublin Road
Columbus, OH 43215-1039
Phone: (614) 487-4000
Fax: (614) 487-4306

Oklahoma

Scott Rice
2900 North Hemlock Circle
Broken Arrow, OK 74012-1185
Phone: (918) 362-4300
Fax: (918) 362-4303

Scott Rice
7501 Broadway Ext
Oklahoma City, OK 73116-9015
Phone: (405) 848-2224
Fax: (405) 848-3999

Oregon

SmithCFI
135 NW Park Avenue
Portland, OR 97209-3394
Phone: (503) 226-4151
Fax: (503) 226-9233

Pennsylvania

A. Pomerantz
701 Market Street, Suite 7000
Philadelphia, PA 19106-1597
Phone: (215) 408-2100
Fax: (215) 408-2110

Corporate Interiors
2900 Potshop Lane
Norristown Business Campus
Norristown, PA 19403
Phone: (610) 631-5400
Fax: (610) 631-2720

Creative Business Interiors Ltd.
210 Division Street
Kingston, PA 18704-2715
Phone: (570) 288-7211
Fax: (570) 288-8553

Franklin Interiors
Suite 600
2740 Smallman Street
Pittsburgh, PA 15222-4720
Phone: (412) 261-2525
Fax: (412) 255-4089

McCartney's Inc.
819 Howard Avenue
Altoona, PA 16601-4727
Phone: (814) 944-8139
Fax: (814) 949-6197

Phillips Group
501 Fulling Mill Road
Middletown, PA 17057-5926
Phone: (717) 944-0400
Fax: (717) 948-5289

Phillips Office Products
1630 Manheim Pike
Lancaster, PA 17601-6800
Phone: (717) 560-9999
Fax: (717) 560-9996

South Carolina

Aiken Office Supply Inc.
2560 Whiskey Road
Aiken, SC 29803-9664
Phone: (803) 648-8339
Fax: (803) 649-4470

McWaters Inc.
1104 Shop Road
Columbia, SC 29201-4743
Phone: (803) 256-8303
Fax: (803) 252-5567

White Office Furniture Ltd.
109 Hampton Street
Rock Hill, SC 29730-4509
Phone: (803) 328-1821
Fax: (803) 324-5207

Wulbern-Koval Company Inc.
1111 Morrison Drive
Charleston, SC 29403-3119
Phone: (843) 577-7666
Fax: (843) 577-7299

Young Office Environments
1280 Ridge Road
Greenville, SC 29607-4626
Phone: (864) 281-9500
Fax: (864) 281-9555

South Dakota

Interstate Office Products Inc.
220 South Main Avenue
Sioux Falls, SD 57104-6310
Phone: (605) 339-0300
Fax: (605) 339-1989

Klein's Office Furniture
208 West Capitol Avenue
Pierre, SD 57501-2307
Phone: (605) 945-3118
Fax: (605) 945-3119

Western Stationers
714 Saint Joseph Street
Rapid City, SD 57701-2721
Phone: (605) 342-3310
Fax: (605) 342-4746

Participating Steelcase Dealers, continued

Tennessee

Interior Design Services Inc.
209 Powell Place
Brentwood, TN 37027-7522
Phone: (615) 376-1200
Fax: (615) 376-1245

Ivan Allen Workspace
2444 Broad Street
Chattanooga, TN 37408-2909
Phone: (423) 265-4400
Fax: (423) 265-7402

Ivan Allen Workspace
Suite 100
2030 Falling Waters Road
Knoxville, TN 37922-5891
Phone: (865) 690-8022
Fax: (865) 690-0853

Memphis Business Interiors
4539 West Distriplex Drive
Memphis, TN 38118-7280
Phone: (901) 360-8899
Fax: (901) 360-8370

Workspace Interiors
402 East Market Street
Kingsport, TN 37660-4828
Phone: (423) 392-2600
Fax: (423) 392-2601

Texas

Abilene Printing & Stationery
218 Cedar Street
Abilene, TX 79601-5720
Phone: (915) 677-2673
Fax: (915) 675-6963

Baker Office Products
1301 13th Street
Lubbock, TX 79401-3915
Phone: (806) 763-2500
Fax: (806) 747-1601

BKM Total Office of Texas L.P.
Suite 100
9755 Clifford Drive
Dallas, TX 75220-5332
Phone: (214) 902-7200
Fax: (214) 902-7201

Hodges Business Interiors Inc.
308 State Highway 75 North
Huntsville, TX 77320-3181
Phone: (936) 295-5708
Fax: (936) 295-5264

Rockford Business Interiors
211 East Riverside Drive
Austin, TX 78704-1203
Phone: (512) 442-0703
Fax: (512) 442-6555

Texas Wilson Office Furniture & Services
655 Richland Hills Drive
San Antonio, TX 78245-2149
Phone: (210) 647-8800
Fax: (210) 647-3110

West Supply Company
2 South Chadbourne Street
San Angelo, TX 76903-5875
Phone: (325) 655-8181
Fax: (325) 655-5480

Yochem's Business Interiors
1901 Lipan Street
Corpus Christi, TX 78408-4035
Phone: (361) 882-2937
Fax: (361) 882-3534

Utah

MidWest Office Furniture
987 South West Temple
Salt Lake City, UT 84101-2988
Phone: (801) 359-7681
Fax: (801) 355-2713

Vermont

Business Interiors
150 Pioneer Drive
Williston, VT 05495-7543
Phone: (802) 862-0434
Fax: (802) 862-0729

Business Interiors
85-91 Main Street
Brattleboro, VT 05301-3257
Phone: (802) 254-7151
Fax: (802) 254-7150

Virginia

Barrows
1302 Rockland Ave
Roanoke, VA 24012-3838
Phone: (540) 362-5700
Fax: (540) 362-4826

Creative Office Environments
1101 East Laburnum Avenue
Richmond, VA 23222-2212
Phone: (804) 329-0400
Fax: (804) 321-3134

Creative Office Environments LLC
1242 Executive Blvd.
Chesapeake, VA 23320-2807
Phone: (757) 549-4801
Fax: (757) 549-2795

Pifer Office Supply
1620 South Loudoun Street
Winchester, VA 22601-4405
Phone: (540) 667-4040
Fax: (540) 667-6656

Washington

Bank & Office Interiors Inc.
6th Floor
5601 Sixth Avenue South
Seattle, WA 98108-2522
Phone: (206) 768-8000
Fax: (206) 768-0236

Bank & Office Interiors Inc.
411 East North Foothills Drive
Spokane, WA 99207-2161
Phone: (509) 483-1000
Fax: (509) 483-1011

West Virginia

Syscan Furniture Solutions
2800 Seventh Avenue
Charleston, WV 25312-1727
Phone: (304) 744-4686
Fax: (304) 744-4980

Syscan Furniture Solutions
1704 Milesground Road
Morgantown, WV 26505-8349
Phone: (304) 284-0200

Wisconsin

Forrer Business Interiors Inc.
555 West Estabrook Blvd.
Milwaukee, WI 53212
Phone: (414) 906-3200
Fax: (414) 906-3299

Steelcase Showrooms and Manufacturing Locations

Steelcase Showrooms and
Manufacturing Locations

Showrooms

Atlanta

Steelcase Inc.
Suite AL-175
One Peachtree Center
303 Peachtree Street NE
Atlanta, GA 30303
Phone: (404) 523-2201

Boston

Steelcase Inc.
Floor 16
155 Federal Street
Boston, MA 02110
Phone: (617) 482-2990

Chicago

Steelcase Worklife Chicago
Suite 1118
1032 Merchandise Mart
Chicago, IL 60654
Phone: (312) 321-3720

Cleveland

Steelcase Inc.
1122 Prospect Ave. E
Cleveland, OH 44115-1229
Phone: (216) 696-5770

Dallas

Steelcase Inc.
Suite 300
3131 McKinney Avenue
Dallas, TX 75204
Phone: (214) 871-3044

Denver

Steelcase Inc.
9960 East 51st Street
Denver, CO 80238
Phone: (303) 298-1888

Detroit

Steelcase Inc.
3000 Town Center
Concourse B, Suite 80
Southfield, MI 48075
Phone: (248) 353-9940

Florida

Steelcase Inc.
Suite 160N
4000 Hollywood Boulevard
Hollywood, FL 33021
Phone: (954) 986-5300

Grand Rapids

Steelcase Inc.
901 44th Street, SE
Grand Rapids, MI 49508
Phone: (616) 247-2710

Houston

Steelcase Inc.
6869 Old Katy Road
Houston, TX 77024
Phone: (713) 880-2111

Indianapolis

Steelcase Inc.
6102 Victory Way
Suite A
Indianapolis, IN 46278
Phone: (317) 216-1420

Irvine

Steelcase Inc.
19100 Von Karman Avenue
Suite 180
Irvine, CA 92612-6557
Phone: (949) 225-9970

Minneapolis

Steelcase Inc.
800 LaSalle Avenue
Suite 1700
Minneapolis, MN 55402
Phone: (612) 332-1820

New Jersey

Steelcase Inc.
400 Interpace Parkway
Building D 4th Floor
Parsippany, NJ 07054
Phone: (973) 331-3400

New York

Steelcase Worklife New York
4 Columbus Circle
New York, NY 10019
Phone: (212) 445-8800

Philadelphia

Steelcase Inc.
One Liberty Place
1650 Market Street, 28th Floor
Philadelphia, PA 19103
Phone: (215) 561-5331

San Francisco

Steelcase Inc.
475 Brannan Street, Suite 110
San Francisco, CA 94107
Phone: (415) 344-6700

Santa Monica

Steelcase Inc.
1630 Stewart Street
Suite 110
Santa Monica, CA 90404
Phone: (310) 586-2600

Seattle

Steelcase Inc.
1191 2nd Avenue, Suite 1550
Seattle, WA 98101
Phone: (206) 464-1670

St. Louis

Steelcase Inc.
Suite 100
1325 North Warson Road
Chesterfield, MO 63132
Phone: (314) 997-9700

Washington D.C.

Steelcase Inc.
Suite 900
1090 Vermont Avenue, NW
Washington, D.C. 20005
Phone: (202) 962-6760

Manufacturing Sites

Athens

214 Durham Drive
Athens, AL 35611
Phone: (256) 232-8112

Brayton International Inc.

PO Box 7288
High Point, NC 27264
Phone: (336) 434-4151

City of Industry

288 Mayo Avenue
City of Industry, CA 91789
Phone: (909) 859-2300

Details—Operations

216 Durham Drive
Athens, AL 35611
Phone: (256) 232-6770

Grand Rapids

901 44th Street, SE
Grand Rapids, MI 49508
Phone: (616) 247-2710

Fletcher

Cane Creek Industrial Park
Old Airport Road
Fletcher, NC 28732
Phone: (828) 684-2241

Grand Rapids Wood Furniture

4300 44th Street, SE
Grand Rapids, MI 49512
Phone: (616) 698-5735

Canada

One Steelcase Road West
7200 Woodbine Avenue
Markham, ON L3R OT3
Phone: (905) 475-6333

Steelcase Design Partnership Companies (SDP)

Brayton International Inc.— Office

255 Swathmore Ave.
High Point, NC 27263
Phone: (336) 434-4151

Details—Corporate/Product Development

25 Ottawa SW
Grand Rapids, MI 49503
Phone: (616) 234-0400

Metro

7220 Edgewater Drive
Oakland, CA 94621-3004
Phone: (510) 567-5200

Steelcase Design Partnership (SDP) Showroom

5th Floor
901 44th Street, SE
Grand Rapids, MI 49508
Phone: (616) 475-2000

Vecta

1800 S. Great Southwest Parkway
Grand Prairie, TX 75051
Phone: (972) 641-2860

Flammability Ratings for Steelcase Panel Systems

GSA requires all panel systems under SIN 711-1 to fall within 200 or less in flamespread and 450 or less in smoke developed in an ASTM E-84 test method. ASTM E-84, NFPA 255, UL 723, and UBC 42-1 all specify identical test methods. Various Building Codes and UL specify acceptance criteria based on flamespread index (FSI) and smoke development (SD). Rating classifications are as follows:

FSI	SD	Rating Classification
25 or less	450 or less	Class 1
26–75	450 or less	Class 2
76–200	450 or less	Class 3

The classifications for Steelcase panel systems products (SIN 711.1) are as follows (all testing on tackable acoustical panel constructions):

System	Rating Classification
Answer	Class 1
Avenir	Class 1
Series 9000 (Conventional or “C”)	Class 1
Series 9000 (Enhanced or “E”)	Class 2
Kick	Class 1
Montage	Class 1
Pathways:	
Segment	Class 1
Technology Wall	Class 1

All fabrics listed as available were tested according to GSA General Specification for Furniture Systems – FCNE 87-441C, currently being revised (either the ASTM E-84 method or NFPA 701).

Answer

► For more detailed product information, see the *Answer Solutions Specification Guide* or consult your Steelcase dealer.



Statement of Line

B2



Specifying

Panels (SIN 711.1)	B23
Worksurfaces (SIN 711.1)	B91
Storage (SIN 711.1)	B129
Lighting (SIN 711.1)	B165

Surface Materials

B179

Resources

B185

Answer

Statement of Line

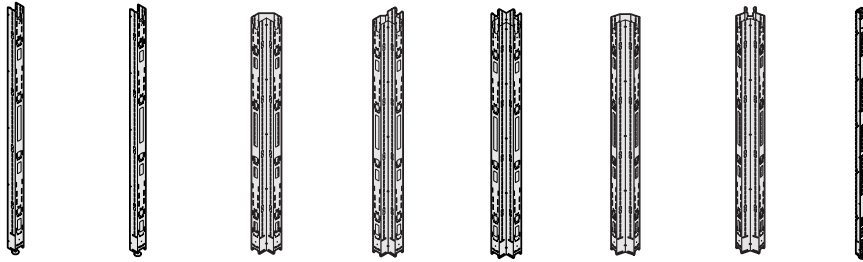

Specifying
▶ Pages B24–B31

Base Junctions

	End-of-Run Base Junctions	In-line Base Junctions	L-Base Junctions	T-Base Junctions	X-Base Junctions	V-Base Junctions	Y-Base Junctions	Wall-Start Junctions
30"H	●	●	●	●	●	●	●	
42"H	●	●	●	●	●	●	●	●
54"H	●	●	●	●	●	●	●	●
66"H	●	●	●	●	●	●	●	●
78"H	●	●	●	●	●	●	●	●

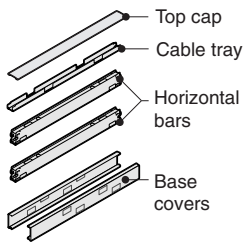

Specifying
▶ Page B46

Base Horizontal Frame Packages

	18"W	24"W	30"W	36"W	42"W	48"W	60"W	72"W
	●	●	●	●	●	●	●	●

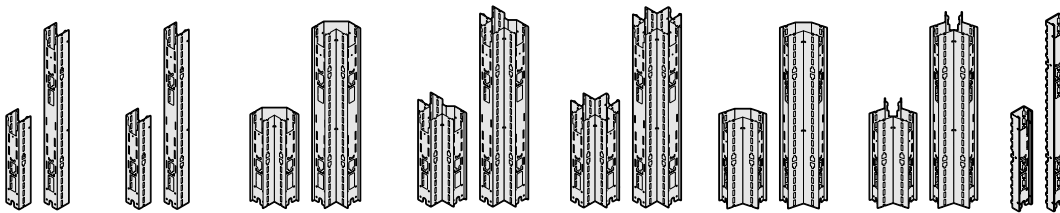

Specifying
▶ Pages B33–B40

Stacking Junctions

	Stacking End-of-Run Junctions	Stacking In-line Junctions	Stacking L Junctions	Stacking T Junctions	Stacking X Junctions	Stacking V Junctions	Stacking Y Junctions	Stacking Wall-Start Junctions
12"H	●	●	●	●	●	●	●	●
24"H	●	●	●	●	●	●	●	●

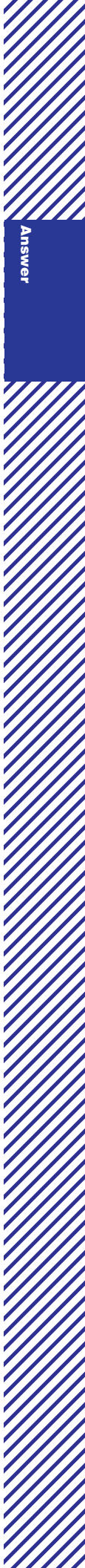

Answer

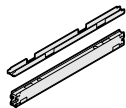

Specifying
▶ Page B47

Stacking Horizontal Frame Packages

	18"W	24"W	30"W	36"W	42"W	48"W	60"W	72"W
	•	•	•	•	•	•	•	•

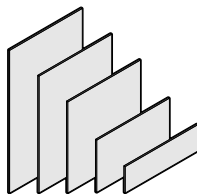

Specifying
▶ Page B50

Performance Tackable Fabric-Covered Panel Skins

	18"W	24"W	30"W	36"W	42"W	48"W	60"W	72"W
12"H	•	•	•	•	•	•	•	•
24"H	•	•	•	•	•	•	•	•
36"H	•	•	•	•	•	•	•	•
48"H	•	•	•	•	•	•	•	•
60"H	•	•	•	•	•	•	•	•

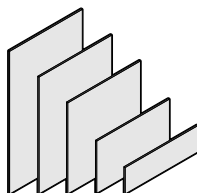

Specifying
▶ Page B52

Tackable Fabric-Covered Panel Skins

	18"W	24"W	30"W	36"W	42"W	48"W	60"W	72"W
12"H	•	•	•	•	•	•	•	•
24"H	•	•	•	•	•	•	•	•
36"H	•	•	•	•	•	•	•	•
48"H	•	•	•	•	•	•	•	•
60"H	•	•	•	•	•	•	•	•

Answer Statement of Line, continued

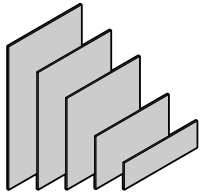

Note: 12"H and 24"H steel skins are available with ribbed and perforated steel option.

Specifying
▶ Page B54

Steel Panel Skins

	18"W	24"W	30"W	36"W	42"W	48"W	60"W	72"W
12"H	●	●	●	●	●	●	●	●
24"H	●	●	●	●	●	●	●	●
36"H	●	●	●	●	●	●	●	●
48"H	●	●	●	●				
60"H	●	●	●	●				

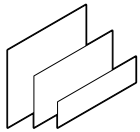

Specifying
▶ Page B56

Marker Board Surfaces for Steel Skins

	24"W	30"W	36"W	42"W	48"W
12"H	●	●	●	●	●
24"H	●	●	●	●	●
36"H	●	●	●	●	●

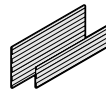

Specifying
▶ Page B57

Slatwall Skins

	24"W	30"W	36"W	42"W	48"W
12"H	●	●	●	●	●
24"H	●	●	●	●	●

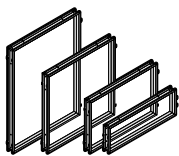

Specifying
▶ Page B58

Glass Windows

	24"W	30"W	36"W	42"W	48"W	60"W	72"W
12"H	●	●	●	●	●	●	●
24"H	●	●	●	●	●		
36"H	●	●	●	●	●		
48"H	●	●	●	●	●		

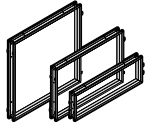

Specifying
▶ Page B59

Pass-Thru Windows

	24"W	30"W	36"W	42"W	48"W	60"W	72"W
12"H	●	●	●	●	●	●	●
24"H	●	●	●	●	●		
36"H	●	●	●	●	●		

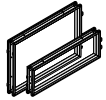

Specifying
▶ Page B60

Glass Windows—Single and Double Pane

	24"W	30"W	36"W	42"W	48"W	60"W	72"W
12"H	●	●	●	●	●	●	●
24"H	●	●	●	●	●	●	

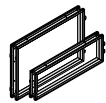

Specifying
▶ Page B61

Single-Pane Glass Window Kits for Use with Custom Glass

	24"W	30"W	36"W	42"W	48"W	60"W	72"W
12"H	●	●	●	●	●	●	●
24"H	●	●	●	●	●	●	

Answer Statement of Line, continued

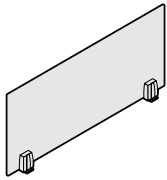

Specifying
▶ Page B62

Panel Top Screens

	30"W	36"W	42"W	48"W
12"H	●	●	●	●

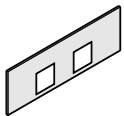

Note: Technology skins are available with ribbed steel or fabric-covered option.

Specifying
▶ Page B63

Technology Skins

	24"W	30"W	36"W	42"W	48"W	60"W	72"W
12"H	●	●	●	●	●	●	●

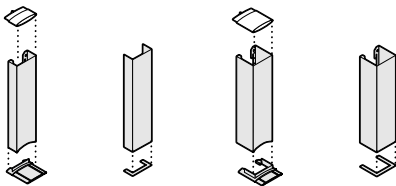

Specifying
▶ Pages B42–B45

Change-of-Height Trim

	Standard Slim Profile	Stacking Slim Profile	Standard Cable Routing	Stacking Cable Routing
12"H	●	●	●	●
24"H	●	●	●	●
36"H	●		●	

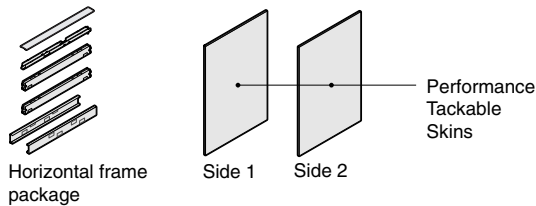

Specifying
▶ Pages B66–B69

Answer

Full Skin Performance Tackable Panel Packages

	18"W	24"W	30"W	36"W	42"W	48"W	60"W	72"W
42"H	●	●	●	●	●	●	●	●
54"H	●	●	●	●	●	●	●	●
66"H	●	●	●	●	●	●	●	●

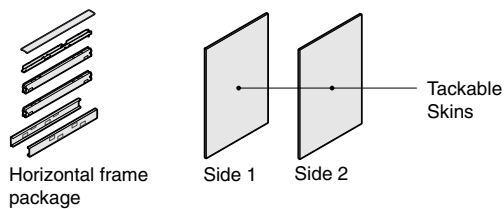

Specifying
▶ Pages B70–B73

Full Skin Tackable Panel Packages

	18"W	24"W	30"W	36"W	42"W	48"W	60"W	72"W
42"H	●	●	●	●	●	●	●	●
54"H	●	●	●	●	●	●	●	●
66"H	●	●	●	●	●	●	●	●

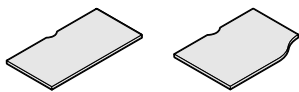

Specifying
▶ Pages B92–B94

Straight and Transition Worksurfaces*

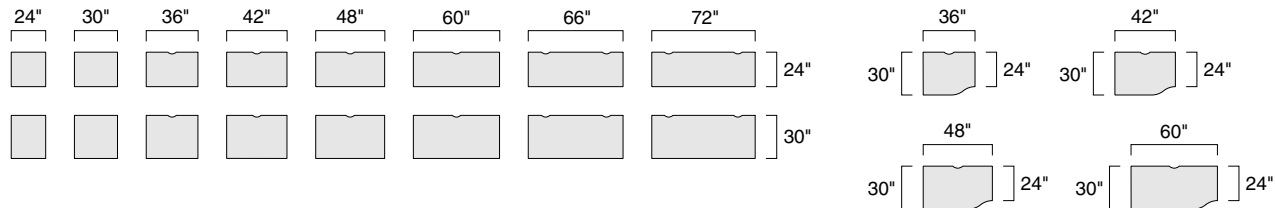

*Left-hand units shown.
Right-hand units are also available.



Specifying
 ▶ Pages B95–B96,
 B98–B101

Straight Corner, Curved Corner, and Extended Corner Worksurfaces*

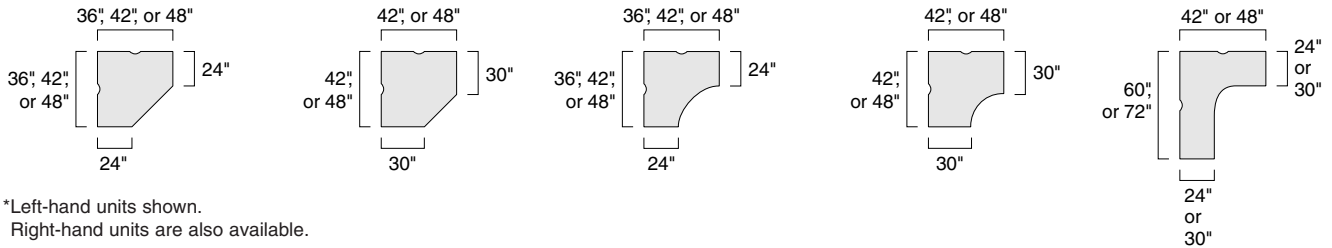

*Left-hand units shown.
 Right-hand units are also available.

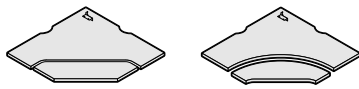

Specifying
 ▶ Page B97

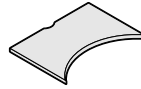

Specifying
 ▶ Page B102

Panel-Supported Straight Corner and Curved Corner Worksurfaces with Adjustable Keyboard Shelf

	42"W	48"W
24"D	●	●
30"D		●

Bridge Worksurfaces

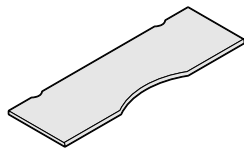
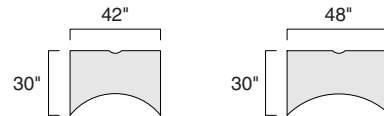

Specifying
 ▶ Page B103

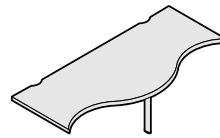

Specifying
 ▶ Page B104

Scoop Worksurface

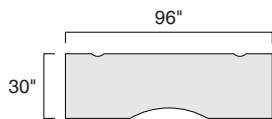

Wave Worksurfaces

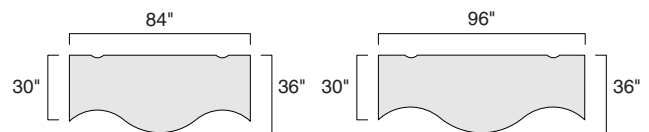

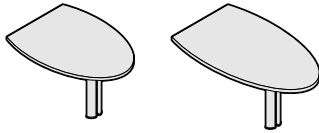

Specifying
▶ Page B106

Peninsula Worksurfaces

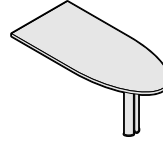
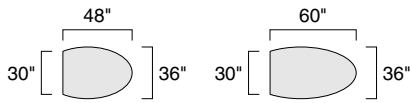

Specifying
▶ Page B106

Bullet Peninsula Worksurfaces

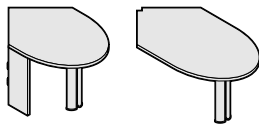
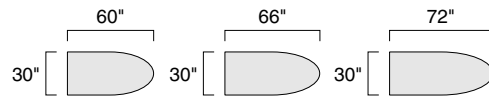

Specifying
▶ Page B108

Angled Peninsula Worksurfaces

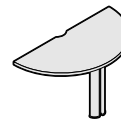
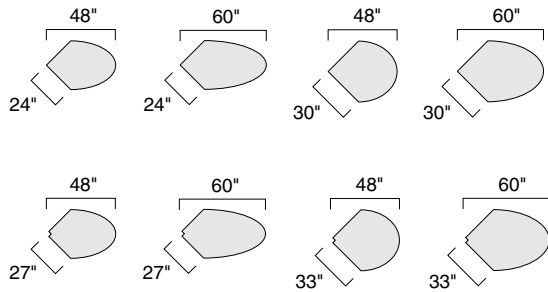

Specifying
▶ Page B110

Spanner Worksurfaces

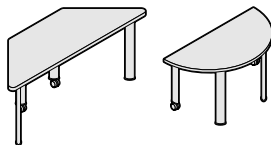
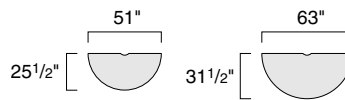

Specifying
▶ Page B111

Trapezoid and Spanner Tables

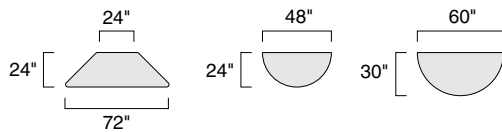

Specifying
▶ Page B112

Oval Worksurfaces

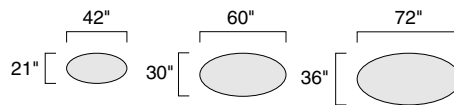

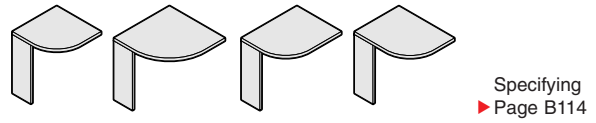
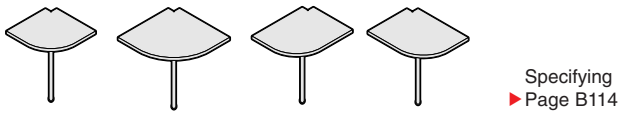

Curved Linking Workspaces

Visitor Workspaces

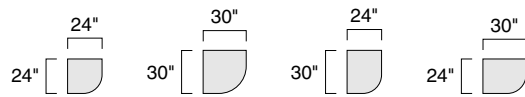
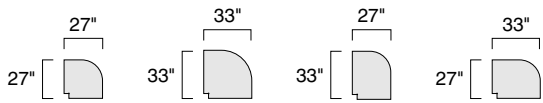

Transaction Countertops

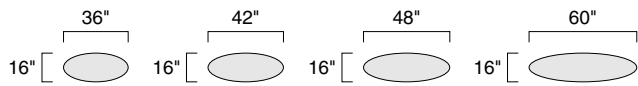

Adjustable-Height Worksurfaces

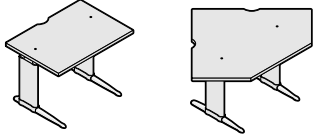

Specifying
▶ Page B117

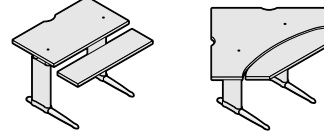

Specifying
▶ Page B117

Single Surface, Crank Adjustable

	37 ³ / ₄ "W	40"W	43 ³ / ₄ "W	46"W
22"D	C		C	
28 ¹ / ₄ "D		●		●

C = Corner

Dual Surface, Crank Adjustable

	37 ³ / ₄ "W	40"W	43 ³ / ₄ "W	46"W
22"D	C		C	
34"D		●		●

C = Corner

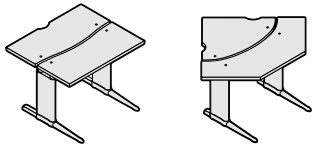

Specifying
▶ Page B117

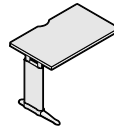

Specifying
▶ Page B118

Bi-Level, Crank Adjustable

	40"W	46"W
22"D	C	C
34"D	●	●

C = Corner

Extension Link

	24 ¹ / ₂ "W	36 ¹ / ₂ "W
22"D	●	●

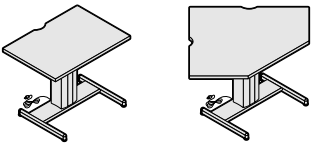

Specifying
▶ Page B119

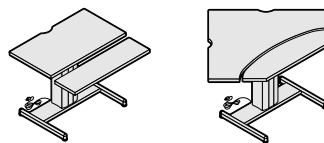

Specifying
▶ Page B119

Single Surface, Electrically Adjustable

	37 ³ / ₄ "W	40"W	43 ³ / ₄ "W	46"W
22"D	C		C	
28 ¹ / ₄ "D		●		●

C = Corner

Dual Surface, Electrically Adjustable

	37 ³ / ₄ "W	40"W	43 ³ / ₄ "W	46"W
22"D	C		C	
34"D		●		●

C = Corner

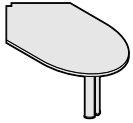

Specifying
▶ Page B120

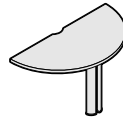

Specifying
▶ Page B121

Angled Peninsula Worksurfaces for Use with Kick

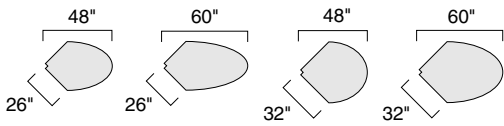

Spanner Worksurfaces for Use with Kick

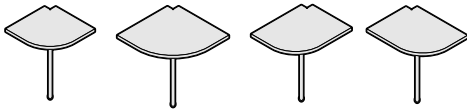
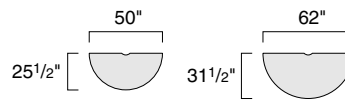

Specifying
▶ Page B122

Curved Linking Worksurfaces for Use with Kick

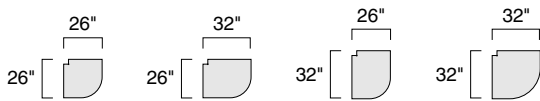

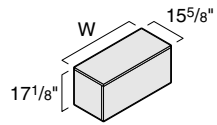

Specifying
▶ Pages B130–B132

Universal Overhead Bins

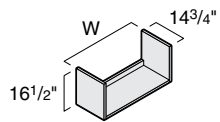
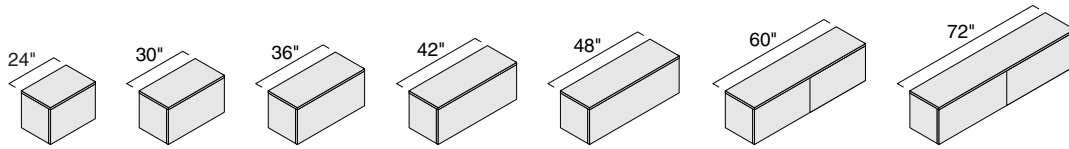

Specifying
▶ Page B133

Universal Full-Height Shelves

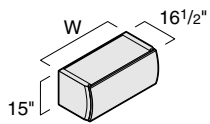
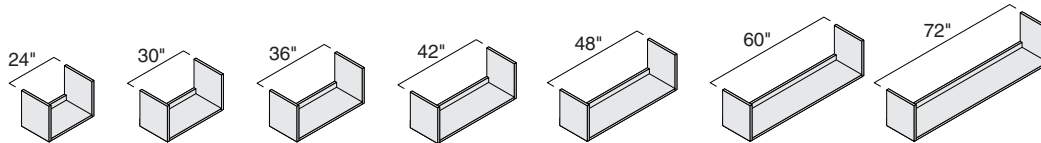

Specifying
▶ Pages B139–B140

Universal Curved Front Bins

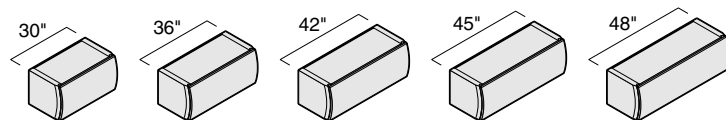

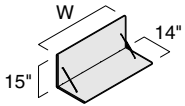

Specifying
▶ Page B141

Universal L-Shelves

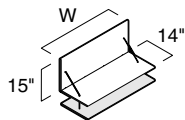
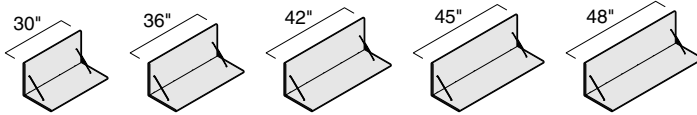

Specifying
▶ Page B142

Universal Stationary Shelves

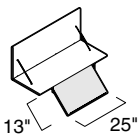
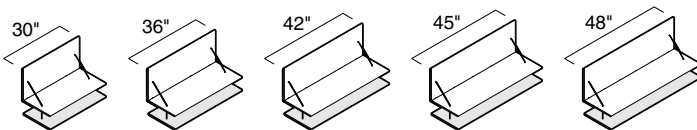

Specifying
▶ Page B142

Universal Display Shelves



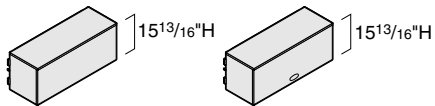

Specifying
▶ Page B146

Answer Overhead Bins

	24"W	30"W	36"W	42"W	48"W	60"W	72"W
16"D	●	●	●	●	●	●	●

Note: Oval pull, fabric-covered door, and wood door options are available.

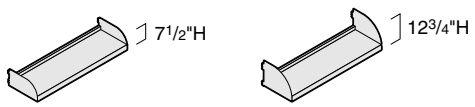

Specifying
▶ Page B148

Answer Shelves

	24"W	30"W	36"W	42"W	48"W	60"W	72"W
15 1/4"D	●	●	●	●	●	●	●

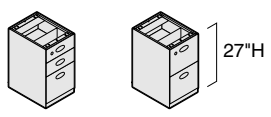

Specifying
▶ Page B150

Answer Fixed Pedestals

	15"W
23 1/2"D	●
29 1/2"D	●

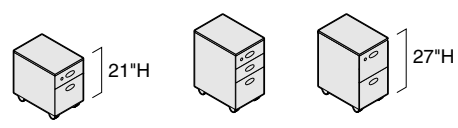

Specifying
▶ Page B152

Answer Mobile Pedestals

	15"W
23 1/2"D	●

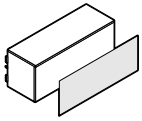

Specifying
▶ Page B160

Flexible Markerboard Surfaces for Binder Bins

	30"W	36"W	42"W	48"W
15"H	•	•	•	•

Canopy lights are task lights that provide broad coverage and evenly balanced light that significantly minimizes glare. They offer a variety of mounting options independent of overhead storage. Canopy lights are designed to complement a variety of Steelcase systems furniture and many competitive furniture lines.

Depth	7 1/16"
Width	24" 36" 48"

Optics
Patented, crescent-shaped lens with specular aluminum reflector.

Scientifically designed reflector and crescent-shaped optics lens for low glare and broad distribution of light.

Ballast
Electronic

Electronic dimmer
Available

Canopy Lights

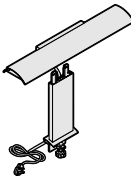
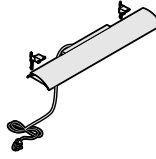
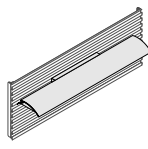
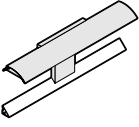
	Panel-Mounted Lights			
	Worksurface-Mounted Canopy Lights	Panel-Mounted Canopy Light	Details Slatwall-Mounted Canopy Light	Details WorkFlo Rail-Mounted Canopy Light
				
	Specifying ▶ Page B166	Specifying ▶ Page B168	Specifying ▶ See <i>Details Specification Guide</i> . Tip: Specify panel-mounted canopy light, and select appropriate mounting options.	
Answer	Yes	Yes	Yes 6	Yes 1 5
Competitive	Yes	Yes 2 3	Yes 6	Yes 1 5
Architectural Drywall	No	Yes 4	No	No

- 1 Use rail-mounting riser. Ordered separately.
- 2 Competitive products that can accommodate canopy lights by using the standard Answer, Avenir, and Series 9000 panel-mounting bracket include:
 - All Steel 8000
 - American Seating Framework
 - Haworth Unigroup, Places
 - HON
 - Kimball Cetra
 - Knoll Morrison, Equity, Rugby
 - K1 System 3000
 - La-Z-Boy Contract
 - Panel Concepts
 - Precision
 - SMED
 - Teknion
 - Trendway
 - Unicore
 - Xception
- 3 Additional brackets can accommodate panel-mounted canopy lights on:
 - Haworth Premise
 - Herman Miller Action Office, Ethospace
 - Knoll System 6, System Z
- 4 Use optional architectural drywall brackets.
- 5 Use Details WorkFlo rail. Ordered separately.
- 6 Use Details slatwall. Ordered separately.

Answer Statement of Line, continued

Shelf lights mount into the recessed bottom of storage shelves and bins to illuminate the worksurface. Three types of shelf lights are available to control the quality of light for specific applications. Each type is compatible with Steelcase systems furniture and all major competitive furniture lines.

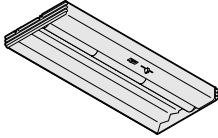
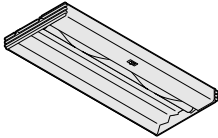
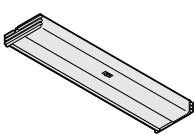
Shelf Lights			
Storage-Mounted Lights			
	Advanced Shelf Light	Standard Shelf Light	Utility Shelf Light
			
Mounting Options	<ul style="list-style-type: none"> • Universal mounting package (standard) • Competitive mounting package 	<ul style="list-style-type: none"> • Universal mounting package (standard) • Competitive mounting package 	<ul style="list-style-type: none"> • Universal mounting package (standard) • Competitive mounting package
	Specifying ▶ Page B172	Specifying ▶ Page B174	Specifying ▶ Page B176
Depth	9¼"	9¼"	5½"
Width	25", 37", or 49"	25", 37", or 49"	19", 25", 37", or 49"
Description	Provides maximum glare control, which makes it the best light for people who perform repetitive functions, do critical visual tasks, or have eyes that are particularly sensitive to light. Minimizing reflected glare is critical for these workers.	The right choice for the majority of people in today's workplace who switch frequently from task to task throughout the day.	Designed for use in display areas, service centers, under transaction tops, and other applications where glare control is not a primary consideration.
Optics	Faceted, specular aluminum reflector	Faceted, white reflector	White reflector
	Optics sleeve to reduce glare and improve light distribution	Contrast sleeve that can be manually rotated to vary light intensity	Prismatic lens—flat acrylic diffuser
Ballasts	<ul style="list-style-type: none"> • Economizer electronic ballast • Electronic ballast 	<ul style="list-style-type: none"> • Economizer electronic ballast • Electronic ballast 	<ul style="list-style-type: none"> • Electronic ballast • Magnetic normal-power-factor ballast
Electronic Dimmer	• Available	• Not available	• Not available
Lens Options	None	None	• Bat-wing lens option

Interface Products

The interface is the point at which the utilities within a panel connect to a building's power and communication network. All power components are field installed.

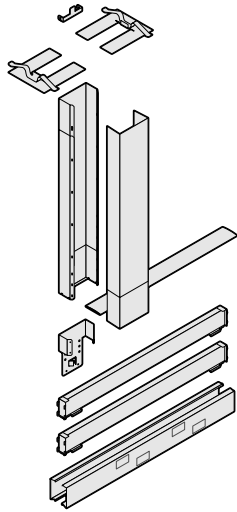

Ceiling-Access Lay-In Utility Package

Specifying
▶ Page B89

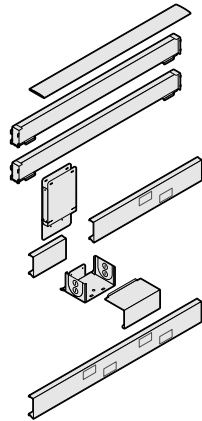

Floor-Access Lay-In Utility Package

Specifying
▶ Page B90

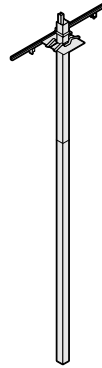

Junction with Utility Pole

Specifying
▶ Page B41

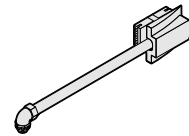

Base Power Infeed

Specifying
▶ Page B82

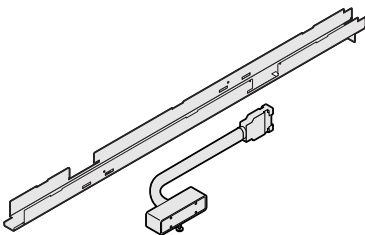

Base Power Infeed for Use in New York City

Specifying
▶ Page B83

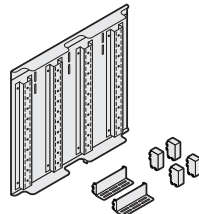

Consolidation Point Kit

Specifying
▶ Page B88

Distribution Products

Distribution refers to the way that power and communication networks are routed through a panel.

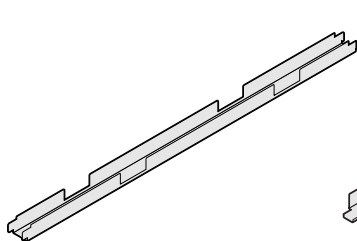

Cable Tray
Specifying
▶ Page B76

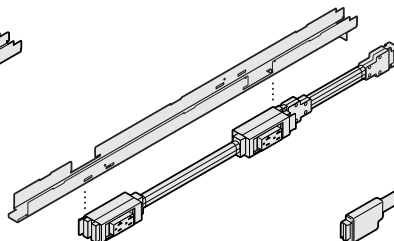

Powerkit
Specifying
▶ Page B77

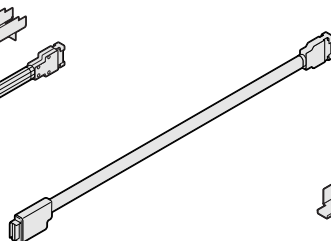

Pass-Through Powerkit
Specifying
▶ Page B78

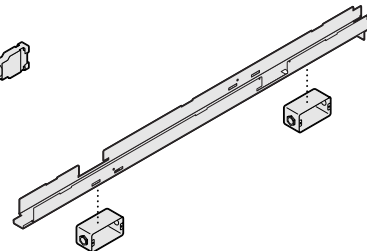

Hardwired Powerkit
Specifying
▶ Page B84

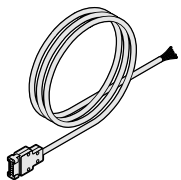

Multipurpose Power Infeed
Specifying
▶ Page B84

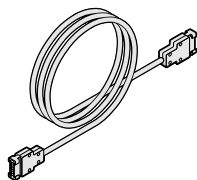

Modular Harness
Specifying
▶ Page B85

Access Products

Access to power and communication networks is accommodated by power receptacles and communication outlets installed in a panel.



Duplex Receptacles
Specifying
▶ Page B80



Face Plate
Specifying
▶ Page B82

Accessories

Accessories are used to help customize your wiring and cabling needs.

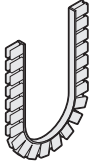

Lay-In Junction Cable Sleeve

Specifying
▶ Page B85



Feed-Through Horizontal Cable Sleeve

Specifying
▶ Page B86

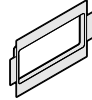

Grommet for Horizontal Bar and Junction

Specifying
▶ Page B86



Grommet for Junction

Specifying
▶ Page B86

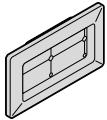

Series 9000 Duplex Cable Grommet

Specifying
▶ Page B87

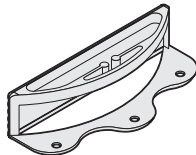

Worksurface Wire Manager

Specifying
▶ Page B128

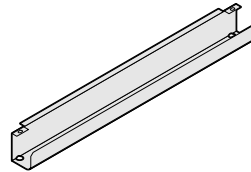

Cable Storage Tray

Specifying
▶ Page B128



Leg Wire Manager

Specifying
▶ Page B128



Vertical Wire Manager

Specifying
▶ Page B178



Specifying Answer Panels

► For more detailed product information, see the *Answer Solutions Specification Guide* or consult your Steelcase dealer.

Panels

In-Line Base Panel Junctions (SIN 711.1)	B24
L, T, and X Base Panel Junctions (SIN 711.1)	B25
Wood L, T, and X Base Panel Junctions (SIN 711.1)	B26
End-of-Run Base Panel Junctions (SIN 711.1)	B27
Wood End-of-Run Base Panel Junctions (SIN 711.1)	B28
V and Y Base Panel Junctions (SIN 711.1)	B29
Wood V and Y Base Panel Junctions (SIN 711.1)	B30
Wall-Start Junctions (SIN 711.1)	B31
Off-Module Panel Connectors (SIN 711.1)	B32
Stacking In-Line Panel Junctions (SIN 711.1)	B33
Stacking L, T, and X Panel Junctions (SIN 711.1)	B34
Wood Stacking L and T Panel Junctions (SIN 711.1)	B35
Stacking End-of-Run Panel Junctions (SIN 711.1)	B36
Wood Stacking End-of-Run Panel Junctions (SIN 711.1)	B37
Stacking V and Y Panel Junctions (SIN 711.1)	B38
Wood Stacking V Panel Junctions (SIN 711.1)	B39
Stacking Wall-Start Junctions (SIN 711.1)	B40
Junctions with Utility Pole (SIN 711.1)	B41
Standard Change-of-Height Trims (SIN 711.1)	B42
Wood Standard Change-of-Height Trims (SIN 711.1)	B43
Stacking Change-of-Height Trims (SIN 711.1)	B44
Wood Stacking Change-of-Height Trims (SIN 711.1)	B45
Base Horizontal Frame Packages (SIN 711.1)	B46
Stacking Horizontal Frame Packages (SIN 711.1)	B47
Frame Components (SIN 711.1)	B48
Performance Tackable Fabric-Covered Panel Skins (SIN 711.1)	B50
Tackable Fabric-Covered Panel Skins (SIN 711.1)	B52
Steel Panel Skins (SIN 711.1)	B54
Marker Board Surfaces for Steel Skins (SIN 711.1)	B56
Slatwall Skins (SIN 711.1)	B57
Glass Window Kits (SIN 711.1)	B58
Pass-Thru Window Kits (SIN 711.1)	B59
Glass Windows for Panel Buildups (SIN 711.1)	B60
Single-Pane Glass Window Kits for Use with Custom Glass (SIN 711.1)	B61
Panel Top Screens (SIN 711.1)	B62
Technology Skins (SIN 711.1)	B63
Technology Covers (SIN 711.1)	B64
42"H and 54"H Full Skin Performance Tackable Panel Packages (SIN 711.1)	B66
66"H Full Skin Performance Tackable Panel Packages (SIN 711.1)	B68
42"H and 54"H Full Skin Tackable Panel Packages (SIN 711.1)	B70
66"H Full Skin Tackable Panel Packages (SIN 711.1)	B72
Buttress (SIN 711.1)	B74
Fence Connectors (SIN 711.1)	B75

Panel Wiring and Cabling

B76

In-Line Base Panel Junctions

SIN 711.1



Tip: In-line base panel junctions do not require junction cap and trim.

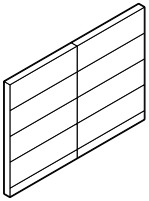

Standard Includes	Required to Specify
-------------------	---------------------

- Junction
- Aligners

Style number

Specification Information		
---------------------------	--	--

•Corresponding •Panel •Height	•Style •Number	•Price
-------------------------------------	-------------------	--------

In-Line Base Panel Junctions

30"	TS730IPJ	\$31
42"	TS742IPJ	\$31
54"	TS754IPJ	\$31
66"	TS766IPJ	\$31
78"	TS778IPJ	\$443
:	:	:

L, T, and X Base Panel Junctions

SIN 711.1

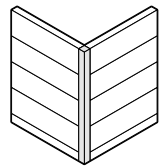

Tip: 78"H panel trim can have only Belgrade fabric.

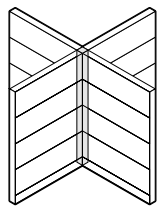
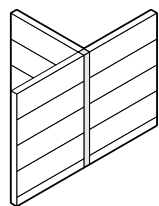
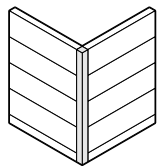

Standard Includes	Required to Specify
<ul style="list-style-type: none"> Junction Upright vertical trim on L and T junction: paint Junction cap on L, T, and X junction: plastic Aligners 	<ol style="list-style-type: none"> Style number Paint color number for upright vertical trim Plastic color number for junction cap Options, if selected (see below) <p>▶ See <i>Surface Materials</i>, page B180.</p>

Options	Price	Required to Specify
Surface Materials <ul style="list-style-type: none"> Paint price group 1 Paint price group 2 Paint price group 3 	No cost +\$11 +\$19	Specify paint color number. Specify paint color number. Specify paint color number.
Upright vertical trim <ul style="list-style-type: none"> Fabric price group 1, 2, 3, or 4 	+\$60	Specify fabric color number for upright and paint color number for base trim on L and T junctions.

Specification Information

Corresponding Panel Height	Style Number	Base Price

L Base Panel Junctions

30"	TS730LPJ	\$116
42"	TS742LPJ	\$116
54"	TS754LPJ	\$116
66"	TS766LPJ	\$116
78"	TS778LPJ	\$161
:	:	:

T Base Panel Junctions

30"	TS730TPJ	\$116
42"	TS742TPJ	\$116
54"	TS754TPJ	\$116
66"	TS766TPJ	\$116
78"	TS778TPJ	\$161
:	:	:

X Base Panel Junctions

30"	TS730XPJ	\$116
42"	TS742XPJ	\$116
54"	TS754XPJ	\$116
66"	TS766XPJ	\$116
78"	TS778XPJ	\$161
:	:	:

Answer

Wood L, T, and X Base Panel Junctions

SIN 711.1

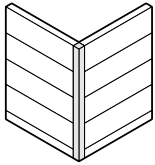

Tip: 78"H panel trim can have only Belgrade or COM non-directional fabric.

Standard Includes	Required to Specify
<ul style="list-style-type: none"> Junction Upright vertical trim on L and T junction: paint Junction cap on L, T, and X junction: wood Aligners 	<ol style="list-style-type: none"> Style number Paint color number for upright vertical trim Wood color number for junction cap Options, if selected (see below) <p>▶ See <i>Surface Materials</i>, page B180.</p>

Options	Price	Required to Specify
Surface Materials <ul style="list-style-type: none"> Paint price group 1 Paint price group 2 Paint price group 3 	No cost +\$11 +\$19	Specify paint color number. Specify paint color number. Specify paint color number.
Upright vertical trim <ul style="list-style-type: none"> Fabric price group 1, 2, 3, or 4 Wood Customiz stain on wood 	+\$60 Prices below +\$15	Specify fabric color number for upright and paint color number for base trim on L and T junctions. Specify wood color number for upright and paint color number for base trim on L and T junctions. Specify <i>with Customiz stain</i> .

Specification Information			
Corresponding Panel Height	Style Number	Base Price	Option (Add \$ to Base Price)
			Wood Upright Vertical Trim

Wood L Base Panel Junctions

30"	TS730LPJW	\$148	+\$143
42"	TS742LPJW	\$148	+\$143
54"	TS754LPJW	\$148	+\$143
66"	TS766LPJW	\$148	+\$183
78"	TS778LPJW	\$193	+\$183

Wood T Base Panel Junctions

30"	TS730TPJW	\$148	+\$143
42"	TS742TPJW	\$148	+\$143
54"	TS754TPJW	\$148	+\$143
66"	TS766TPJW	\$148	+\$183
78"	TS778TPJW	\$193	+\$183

Wood X Base Panel Junctions

30"	TS730XPJW	\$148	N.A.
42"	TS742XPJW	\$148	N.A.
54"	TS754XPJW	\$148	N.A.
66"	TS766XPJW	\$148	N.A.
78"	TS778XPJW	\$193	N.A.

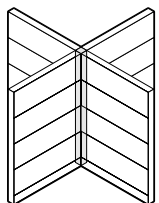
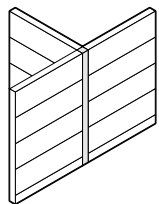
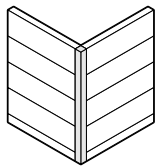

End-of-Run Base Panel Junctions

SIN 711.1



Tip: 78"H panel trim can have only Belgrade fabric.

Tip: End-of-run trim adds 1" to footprint.

Standard Includes	Required to Specify
<ul style="list-style-type: none"> • Junction • Upright vertical trim and base trim on end-of-run junction: paint • Junction cap on end-of-run junction: plastic 	<ol style="list-style-type: none"> 1 Style number 2 Paint color number for upright vertical trim and base trim 3 Plastic color number for junction cap 4 Options, if selected (see below) <p>▶ See <i>Surface Materials</i>, page B180.</p>

Options	Price	Required to Specify
Surface Materials <ul style="list-style-type: none"> • Paint price group 1 • Paint price group 2 • Paint price group 3 	No cost +\$11 +\$19	Specify paint color number. Specify paint color number. Specify paint color number.
Upright vertical trim <ul style="list-style-type: none"> • Fabric price group 1, 2, 3, or 4 	+\$60	Specify fabric color number for upright and paint color for base trim.

Specification Information		
Corresponding Panel Height	Style Number	Base Price
30"	TS730EPJ	\$44
42"	TS742EPJ	\$44
54"	TS754EPJ	\$44
66"	TS766EPJ	\$44
78"	TS778EPJ	\$64
:	:	:

Answer

Wood End-of-Run Base Panel Junctions

SIN 711.1



Tip: 78"H panel trim can have only Belgrade fabric.

Tip: End-of-run trim adds 1" to footprint.

Standard Includes	Required to Specify
<ul style="list-style-type: none"> • Junction • Upright vertical trim and base trim on end-of-run junction: paint • Junction cap on end-of-run junction: wood 	<ol style="list-style-type: none"> 1 Style number 2 Paint color number for upright vertical trim and base trim 3 Wood color number for junction cap 4 Options, if selected (see below) <p>▶ See <i>Surface Materials</i>, page B180.</p>

Options	Price	Required to Specify
Surface Materials <ul style="list-style-type: none"> • Paint price group 1 • Paint price group 2 • Paint price group 3 	No cost +\$11 +\$19	Specify paint color number. Specify paint color number. Specify paint color number.
Upright vertical trim <ul style="list-style-type: none"> • Fabric price group 1, 2, 3, or 4 • Wood • Customiz stain on wood 	+\$60 Prices below +\$15	Specify fabric color number for upright and paint color number for base trim. Specify wood color number for upright and paint color number for base trim. Specify <i>with Customiz stain</i> .

Specification Information			
Corresponding Panel Height	Style Number	Base Price	Option
			(Add \$ to Base Price)
			Wood Upright Vertical Trim
30"	TS730EPJW	\$76	+\$143
42"	TS742EPJW	\$76	+\$143
54"	TS754EPJW	\$76	+\$143
66"	TS766EPJW	\$76	+\$183
78"	TS778EPJW	\$96	+\$183
:	:	:	:

V and Y Base Panel Junctions

SIN 711.1

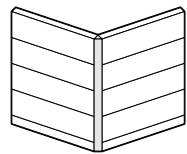

Tip: 78"H panel trim can have only Belgrade fabric.

Standard Includes	Required to Specify
<ul style="list-style-type: none"> • Junction • Upright vertical trim on V junction: paint • Junction cap on V and Y junction: plastic • Aligners 	<ol style="list-style-type: none"> 1 Style number 2 Paint color number for upright vertical trim 3 Plastic color number for junction cap 4 Options, if selected (see below) <p>▶ See <i>Surface Materials</i>, page B180.</p>

Options	Price	Required to Specify
Surface Materials <ul style="list-style-type: none"> • Paint price group 1 • Paint price group 2 • Paint price group 3 	No cost +\$11 +\$19	Specify paint color number. Specify paint color number. Specify paint color number.
Upright vertical trim <ul style="list-style-type: none"> • Fabric price group 1, 2, 3, or 4 	+\$60	Specify fabric color number for upright and paint color number for base trim on V junctions.

Specification Information		
Corresponding Panel Height	Style Number	Base Price

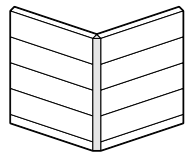

V Base Panel Junctions

30"	TS730VPJ	\$176
42"	TS742VPJ	\$176
54"	TS754VPJ	\$176
66"	TS766VPJ	\$176
78"	TS778VPJ	\$244
:	:	:

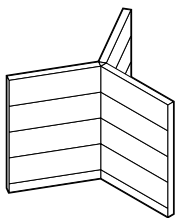

Y Base Panel Junctions

30"	TS730YPJ	\$176
42"	TS742YPJ	\$176
54"	TS754YPJ	\$176
66"	TS766YPJ	\$176
78"	TS778YPJ	\$244
:	:	:

Wood V and Y Base Panel Junctions

SIN 711.1

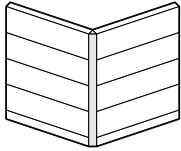

Tip: 78"H panel trim can have only Belgrade or COM non-directional fabric.

Standard Includes	Required to Specify
<ul style="list-style-type: none"> Junction Upright vertical trim on V junction: paint Junction cap on V and Y junction: wood Aligners 	<ol style="list-style-type: none"> Style number Paint color number for upright vertical trim Wood color number for junction cap Options, if selected (see below) <p>▶ See <i>Surface Materials</i>, page B180.</p>

Options	Price	Required to Specify
Surface Materials <ul style="list-style-type: none"> Paint price group 1 Paint price group 2 Paint price group 3 	No cost +\$11 +\$19	Specify paint color number. Specify paint color number. Specify paint color number.
Upright vertical trim <ul style="list-style-type: none"> Fabric price group 1, 2, 3, or 4 Wood Customiz stain on wood 	+\$60 Prices below +\$15	Specify fabric color number for upright and paint color number for base trim on V junctions. Specify wood color number for upright and paint color number for base trim on V junctions. Specify <i>with Customiz stain</i> .

Specification Information			
Corresponding Panel Height	Style Number	Base Price	Option
			(Add \$ to Base Price)
			Wood Upright Vertical Trim

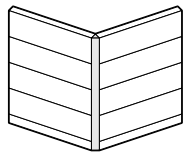

Wood V Base Panel Junctions

30"	TS730VPJW	\$208	+\$143
42"	TS742VPJW	\$208	+\$143
54"	TS754VPJW	\$208	+\$143
66"	TS766VPJW	\$208	+\$183
78"	TS778VPJW	\$276	+\$183

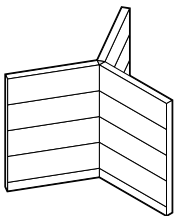

Wood Y Base Panel Junctions

30"	TS730YPJW	\$208	N.A.
42"	TS742YPJW	\$208	N.A.
54"	TS754YPJW	\$208	N.A.
66"	TS766YPJW	\$208	N.A.
78"	TS778YPJW	\$276	N.A.

Wall-Start Junctions

SIN 711.1



Tip: Must be used with off-module panel connector, ordered separately.

Standard Includes	Required to Specify
<ul style="list-style-type: none">Junction: black paint only	Style number

Specification Information

Height	Style Number	Price
42"	TS742WPJ	\$116
54"	TS754WPJ	\$116
66"	TS766WPJ	\$116
78"	TS778WPJ	\$222
:	:	:

Answer

Off-Module Panel Connectors

SIN 711.1

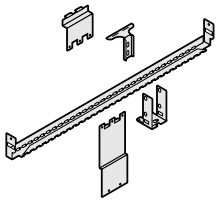

Tip: Must be used with wall start junctions, ordered separately.

Tip: Wall start junctions manufactured before October 2002 will not work with off-module panel connectors.

Standard Includes	Required to Specify
-------------------	---------------------

- Top and bottom bracket
- Bottom channel
- Top cap filler: plastic

- 1 Style number
- 2 Plastic color number for filler
- ▶ See *Surface Materials*, page B180.

Specification Information		
•Width	•Style Number	•Price

•Width	•Style Number	•Price
24"	TS724BKT	\$189
30"	TS730BKT	\$189
36"	TS736BKT	\$189
42"	TS742BKT	\$189
48"	TS748BKT	\$189
60"	TS760BKT	\$189
72"	TS772BKT	\$189
:	:	:

Stacking In-Line Panel Junctions

SIN 711.1



Tip: Stacking in-line junctions do not require junction cap and trim.

Standard Includes	Required to Specify
<ul style="list-style-type: none"> Junction: black paint only Fork connectors: black paint only 	Style number

Specification Information

Height	Style Number	Price
12"	TS712IPJS	\$221
24"	TS724IPJS	\$221
:	:	:

Answer

Stacking L, T, and X Panel Junctions

SIN 711.1

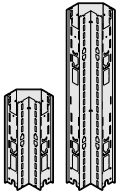

Tip: Junction cap is not included. Use the junction cap from the base junction you are stacking on.

Standard Includes	Required to Specify
<ul style="list-style-type: none"> Junction: black paint only Upright vertical trim on L and T junctions: paint Fork connectors: black paint only Stacking trim aligner on L and T junctions: black plastic only 	<ul style="list-style-type: none"> 1 Style number 2 Paint color number for upright vertical trim 3 Options, if selected (see below) ▶ See <i>Surface Materials</i>, page B180.

Options	Price	Required to Specify
Surface Materials <ul style="list-style-type: none"> Paint price group 1 Paint price group 2 Paint price group 3 	<ul style="list-style-type: none"> No cost +\$11 +\$19 	<ul style="list-style-type: none"> Specify paint color number. Specify paint color number. Specify paint color number.
Upright vertical trim <ul style="list-style-type: none"> Fabric price group 1, 2, 3, or 4 	<ul style="list-style-type: none"> +\$60 	<ul style="list-style-type: none"> Specify fabric color number for upright vertical trim.

Specification Information		
Height	Style Number	Base Price

Stacking L Panel Junctions

12"	TS712LPJS	\$221
24"	TS724LPJS	\$221
:	:	:

Stacking T Panel Junctions

12"	TS712TPJS	\$221
24"	TS724TPJS	\$221
:	:	:

Stacking X Panel Junctions

12"	TS712XPJS	\$221
24"	TS724XPJS	\$221
:	:	:

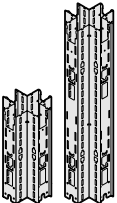
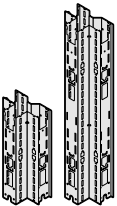
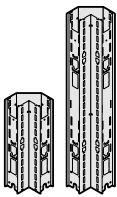

Wood Stacking L and T Panel Junctions

SIN 711.1

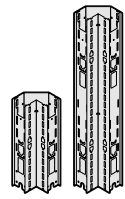

Tip: Junction cap is not included. Use the junction cap from the base junction you are stacking on.

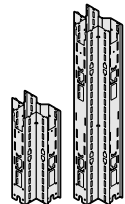
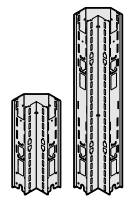

Standard Includes	Required to Specify
<ul style="list-style-type: none"> Junction: black paint only Upright vertical trim on L and T junctions: wood Fork connectors: black paint only Stacking trim aligner on L and T junctions: black plastic only 	<ol style="list-style-type: none"> Style number Wood color number for upright vertical trim Options, if selected (see below) <p>▶ See <i>Surface Materials</i>, page B180.</p>

Options	Price	Required to Specify
Surface Materials <ul style="list-style-type: none"> Customiz stain on wood 	+\$10	Specify with <i>Customiz stain</i> .

Specification Information		
• Height	• Style Number	• Base Price

Wood Stacking L Panel Junctions

12"	TS712LPJSW	\$300
24"	TS724LPJSW	\$300

Wood Stacking T Panel Junctions

12"	TS712TPJSW	\$300
24"	TS724TPJSW	\$300

Stacking End-of-Run Panel Junctions

SIN 711.1

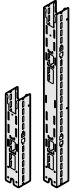

Tip: Junction cap is not included. Use the junction cap from the base junction you are stacking on.

Standard Includes	Required to Specify
<ul style="list-style-type: none"> Junction: black paint only Upright vertical trim on end-of-run junction: paint Fork connectors: black paint only Stacking trim aligner: black plastic only 	<ol style="list-style-type: none"> Style number Paint color number for upright vertical trim Options, if selected (see below) <p>▶ See <i>Surface Materials</i>, page B180.</p>

Options	Price	Required to Specify
Surface Materials <ul style="list-style-type: none"> Paint price group 1 Paint price group 2 Paint price group 3 	No cost +\$11 +\$19	Specify paint color number. Specify paint color number. Specify paint color number.
Upright vertical trim <ul style="list-style-type: none"> Fabric price group 1, 2, 3, or 4 	+\$60	Specify fabric color number for upright vertical trim.

Specification Information		
Height	Style Number	Base Price
12"	TS712EPJS	\$118
24"	TS724EPJS	\$118

Wood Stacking End-of-Run Panel Junctions

SIN 711.1

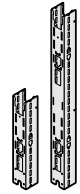

Tip: Junction cap is not included. Use the junction cap from the base junction you are stacking on.

Standard Includes	Required to Specify
<ul style="list-style-type: none"> Junction: black paint only Upright vertical trim on end-of-run junction: wood Fork connectors: black paint only Stacking trim aligner: black plastic only 	<ol style="list-style-type: none"> Style number Wood color number for upright vertical trim Options, if selected (see below) <p>▶ See <i>Surface Materials</i>, page B180.</p>

Options	Price	Required to Specify
Surface Materials <ul style="list-style-type: none"> Customiz stain on wood 	+\$10	Specify with <i>Customiz stain</i> .

Specification Information		
Height	Style Number	Base Price
12"	TS712EPJSW	\$197
24"	TS724EPJSW	\$197

Answer

Stacking V and Y Panel Junctions

SIN 711.1

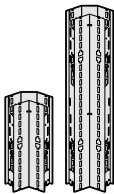

Tip: Junction cap is not included. Use the junction cap from the base junction you are stacking on.

Standard Includes	Required to Specify
<ul style="list-style-type: none"> Junction: black paint only Upright vertical trim on V junctions: paint Fork connectors: black paint only Stacking trim aligner on V junctions: black plastic only 	<ol style="list-style-type: none"> Style number Paint color number for upright vertical trim Options, if selected (see below) <p>▶ See <i>Surface Materials</i>, page B180.</p>

Options	Price	Required to Specify
Surface Materials <ul style="list-style-type: none"> Paint price group 1 Paint price group 2 Paint price group 3 	No cost +\$11 +\$19	Specify paint color number. Specify paint color number. Specify paint color number.
Upright vertical trim <ul style="list-style-type: none"> Fabric price group 1, 2, 3, or 4 	+\$60	Specify fabric color number for upright vertical trim on V junctions.

Specification Information

Height	Style Number	Base Price
--------	--------------	------------

Stacking V Panel Junctions

12"	TS712VPJS	\$279
24"	TS724VPJS	\$279
:	:	:

Stacking Y Panel Junctions

12"	TS712YPJS	\$279
24"	TS724YPJS	\$279
:	:	:

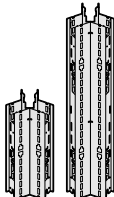
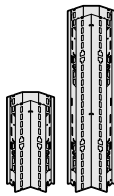

Wood Stacking V Panel Junctions

SIN 711.1

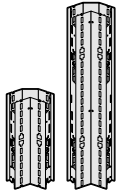

Tip: Junction cap is not included. Use the junction cap from the base junction you are stacking on.

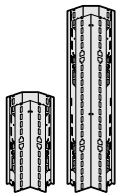

Standard Includes	Required to Specify
<ul style="list-style-type: none"> Junction: black paint only Upright vertical trim on V junctions: wood Fork connectors: black paint only Stacking trim aligner on V junctions: black plastic only 	<ol style="list-style-type: none"> Style number Wood color number for upright vertical trim Options, if selected (see below) <p>▶ See <i>Surface Materials</i>, page B180.</p>

Options	Price	Required to Specify
Surface Materials <ul style="list-style-type: none"> Customiz stain on wood 	+\$10	Specify with <i>Customiz stain</i> .

Specification Information		
• Height	• Style Number	• Base Price
•	•	•
•	•	•
•	•	•

Wood Stacking V Panel Junctions		
12"	TS712VPJSW	\$358
24"	TS724VPJSW	\$358
•	•	•

Answer

Stacking Wall-Start Junctions

SIN 711.1

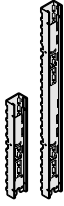

Standard Includes	Required to Specify
-------------------	---------------------

- Junction: black paint only
- Fork connector: black paint only

Style number

Specification Information		
Height	Style Number	Base Price
12"	TS712WPJS	\$221
24"	TS724WPJS	\$221

Height	Style Number	Base Price
12"	TS712WPJS	\$221
24"	TS724WPJS	\$221

Junctions with Utility Pole

SIN 711.1

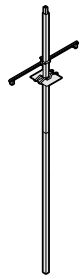

Tip: Order multipurpose power infeed separately.
▶ Page B84

Standard Includes	Required to Specify
<ul style="list-style-type: none"> • Junction • Upright vertical trim on L and In-line: paint • Junction cap on L, In-line, and T junctions: plastic • Utility pole: paint • Ceiling trim plate: white paint only • Mounting brackets 	<ol style="list-style-type: none"> 1 Style number 2 Paint color number for upright and utility pole 3 Plastic color number for junction cap 4 Options, if selected (see below) <p>▶ See <i>Surface Materials</i>, page B180.</p>

Options	Price	Required to Specify
Surface Materials <ul style="list-style-type: none"> • Paint price group 1 • Paint price group 2 • Paint price group 3 	No cost +\$11 +\$19	Specify paint color number. Specify paint color number. Specify paint color number.

Specification Information

Corresponding Panel Height	Style Number	Base Price

L and In-Line Panel Junctions with Utility Pole

42"	TS742LUP	\$417
54"	TS754LUP	\$417
66"	TS766LUP	\$417
78"	TS778LUP	\$460

T Panel Junctions with Utility Pole

42"	TS742TUP	\$417
54"	TS754TUP	\$417
66"	TS766TUP	\$417
78"	TS778TUP	\$460

End-of-Run Junctions with Utility Pole

42"	TS742ERUP	\$253
54"	TS754ERUP	\$253
66"	TS766ERUP	\$253
78"	TS778ERUP	\$266

Answer

Standard Change-of-Height Trims

SIN 711.1

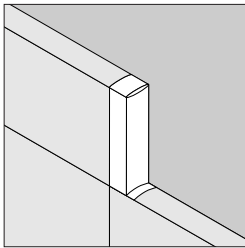
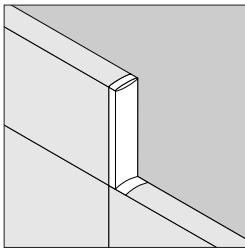

Tip: Cable-routing trim only provides vertical cable routing capacity.

Tip: Remember to specify the shortened top cap option for the lower panels in change-of-height configurations when using either type of change-of-height trim.

Standard Includes	Required to Specify
<ul style="list-style-type: none"> Upright change-of-height trim: paint One L, T, and X change-of-height junction cap, and one in-line change-of-height junction cap: plastic One bottom filler: plastic 	<ol style="list-style-type: none"> Style number Paint color number for upright Plastic color number for junction caps and bottom filler Options, if selected (see below) <p>▶ See <i>Surface Materials</i>, page B180.</p>

Options	Price	Required to Specify
Surface Materials <ul style="list-style-type: none"> Paint price group 1 Paint price group 2 Paint price group 3 	No cost +\$11 +\$19	Specify paint color number. Specify paint color number. Specify paint color number.
Upright change-of-height trim <ul style="list-style-type: none"> Fabric price group 1, 2, 3, or 4 		Specify fabric color number for upright change-of-height trim.

Specification Information		
Corresponding Panel Height	Style Number	Base Price

Slim Profile		
Panel Height	Style Number	Base Price
12"	TS712CHS	\$42
24"	TS724CHS	\$48
36"	TS736CHS	\$58

With Cable-Routing Capability		
Panel Height	Style Number	Base Price
12"	TS712CH	\$42
24"	TS724CH	\$48
36"	TS736CH	\$58

Wood Standard Change-of-Height Trims

SIN 711.1

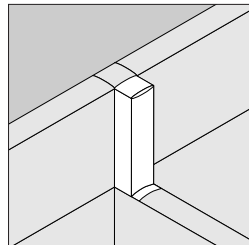
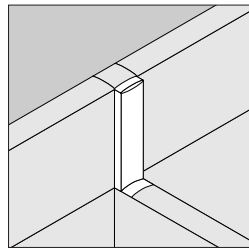

Tip: Cable-routing trim only provides vertical cable routing capacity.

Tip: Remember to specify the shortened top cap option for the lower panels in change-of-height configurations when using either type of change-of-height trim.

Tip: Wood junction cap for in-line change-of-height applications is available as an option.

Standard Includes	Required to Specify
<ul style="list-style-type: none"> Upright change-of-height trim: paint One L, T, and X change-of-height junction cap: wood One bottom filler: wood 	<ol style="list-style-type: none"> Style number Paint color number for upright Wood color number for junction caps and bottom filler Options, if selected (see below) <p>▶ See <i>Surface Materials</i>, page B180.</p>

Options	Price	Required to Specify
Surface Materials <ul style="list-style-type: none"> Paint price group 1 Paint price group 2 Paint price group 3 	<ul style="list-style-type: none"> No cost +\$ 11 +\$ 19 	<ul style="list-style-type: none"> Specify paint color number. Specify paint color number. Specify paint color number.
Upright change-of-height trim		
<ul style="list-style-type: none"> Fabric price group 1, 2, 3, or 4 Wood Customiz stain on wood 	<ul style="list-style-type: none"> +\$ 40 +\$117 +\$ 10 	<ul style="list-style-type: none"> Specify fabric color number for upright change-of-height trim. Specify wood color number for upright change-of-height trim. Specify with <i>Customiz stain</i>.
In-line change-of-height junction cap		
<ul style="list-style-type: none"> Wood Customiz stain on wood 	<ul style="list-style-type: none"> No cost No cost 	<ul style="list-style-type: none"> Specify with <i>wood in-line change-of-height junction cap</i>. Specify with <i>Customiz stain</i>.

Specification Information		
Corresponding Panel Height	Style Number	Base Price

Slim Profile		
12"	TS712CHSW	\$74
24"	TS724CHSW	\$80
36"	TS736CHSW	\$90

With Cable-Routing Capability		
12"	TS712CHW	\$74
24"	TS724CHW	\$80
36"	TS736CHW	\$90

Answer

Stacking Change-of-Height Trims

SIN 711.1

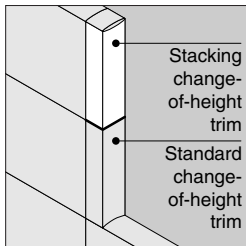
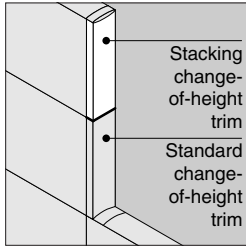

Tip: Stacking change-of-height trim is only used on the second tier in a change-of-height configuration.

Tip: Change-of-height junction cap is not included with stacking change-of-height trim. Use the change-of-height junction cap from the standard change-of-height trim you are stacking on.

Tip: Cable-routing trim only provides vertical cable routing capacity.

Standard Includes	Required to Specify
<ul style="list-style-type: none"> Upright change-of-height trim: paint Stacking trim aligner: black plastic only 	<ul style="list-style-type: none"> 1 Style number 2 Paint color number for trim 3 Options, if selected (see below) <p>▶ See <i>Surface Materials</i>, page B180.</p>

Surface Materials	Options	Price	Required to Specify
	<ul style="list-style-type: none"> Paint price group 1 Paint price group 2 Paint price group 3 	<ul style="list-style-type: none"> No cost +\$11 +\$19 	<ul style="list-style-type: none"> Specify paint color number. Specify paint color number. Specify paint color number.
	<ul style="list-style-type: none"> Upright change-of-height trim Fabric price group 1, 2, 3, or 4 	<ul style="list-style-type: none"> +\$40 	<ul style="list-style-type: none"> Specify fabric color number for upright change-of-height trim.

Specification Information		
Corresponding Panel Height	Style Number	Base Price

Stacking Change-of-Height Trim with Slim Profile

12"	TS712CHST	\$40
24"	TS724CHST	\$44

Stacking Change-of-Height Trim with Cable Routing Capability

12"	TS712CHT	\$40
24"	TS724CHT	\$44

Wood Stacking Change-of-Height Trims

SIN 711.1

Answer

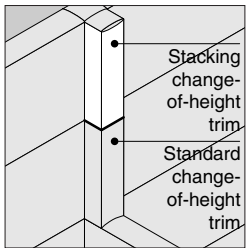
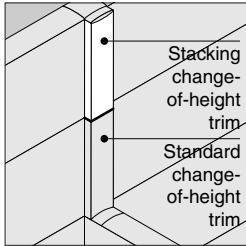

Tip: Stacking change-of-height trim is only used on the second tier in a change-of-height configuration.

Tip: Change-of-height junction cap is not included with stacking change-of-height trim. Use the change-of-height junction cap from the standard change-of-height trim you are stacking on.

Tip: Cable-routing trim only provides vertical cable routing capacity.

Standard Includes	Required to Specify
<ul style="list-style-type: none"> • Upright change-of-height trim: wood • Stacking trim aligner: black plastic only 	<ul style="list-style-type: none"> 1 Style number 2 Wood color number for trim 3 Options, if selected (see below) ▶ See <i>Surface Materials</i>, page B180.

Options	Price	Required to Specify
Surface Materials <ul style="list-style-type: none"> • Customiz stain on wood 	+\$10	Specify with <i>Customiz stain</i> .

Specification Information		
Corresponding Panel Height	Style Number	Base Price

Wood Stacking Change-of-Height Trim with Slim Profile		
12"	TS712CHSTW	\$119
24"	TS724CHSTW	\$123
:	:	:

Wood Stacking Change-of-Height Trim with Cable Routing Capability		
12"	TS712CHTW	\$119
24"	TS724CHTW	\$123
:	:	:

Base Horizontal Frame Packages

for Panel Buildups

SIN 711.1

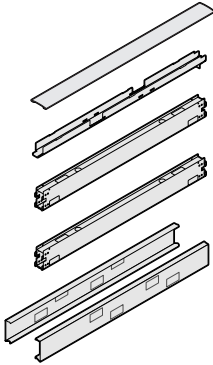

Tip: You must order vertical junctions separately to complete your frame.

▶ Page B24

Tip: Remember to order skins to complete the panel.

Tip: One adjustable brace is included with 60"W and 72"W horizontal frame packages to stabilize 60"W and 72"W panels with segmented skins.

▶ Page B48

Tip: Remember to specify an optional shortened change-of-height top cap on any panel in a change-of-height configuration.

Exception: The tallest panel in the configuration never needs a shortened change-of-height top cap.

Standard Includes	Required to Specify
<ul style="list-style-type: none"> Standard length top cap: color default determined by base trim paint color Cable lay-in tray: black paint only Base trim: paint Two horizontal connecting bars: black paint only One adjustable brace on 60"W and 72"W: black paint only 	<ul style="list-style-type: none"> 1 Style number 2 Paint color number for base trim 3 Options, if selected (see below) <p>▶ See <i>Surface Materials</i>, page B180.</p>

Options	Price	Required to Specify
Surface Materials <ul style="list-style-type: none"> Paint price group 1 Paint price group 2 Paint price group 3 	<ul style="list-style-type: none"> No cost +\$11 +\$19 	<ul style="list-style-type: none"> Specify paint color number. Specify paint color number. Specify paint color number.
Top cap <ul style="list-style-type: none"> Wood Customiz stain on wood 	<ul style="list-style-type: none"> Prices below +\$13 	<ul style="list-style-type: none"> Specify with <i>wood top cap</i> and select wood color number. Specify with <i>Customiz stain</i>.
Change-of-Height Shortened Top Cap <ul style="list-style-type: none"> Change-of-height at one end of top cap Change-of-height at both ends of top cap on 36"W and wider frame packages 	<ul style="list-style-type: none"> +\$ 5 +\$ 5 	<ul style="list-style-type: none"> Specify with <i>change-of-height, one end</i>. Specify with <i>change-of-height, both ends</i>.

Specification Information			
Width	Style Number	Base Price	Option (Add \$ to Base Price)
18"	TS718HF	\$30	+\$141
24"	TS724HF	\$32	+\$141
30"	TS730HF	\$35	+\$141
36"	TS736HF	\$37	+\$141
42"	TS742HF	\$42	+\$141
48"	TS748HF	\$45	+\$141
60"	TS760HF	\$57	+\$189
72"	TS772HF	\$79	+\$189
:	:	:	:

Stacking Horizontal Frame Packages

for Panel Buildups

SIN 711.1

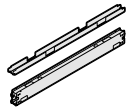

Tip: You must order vertical stacking junctions separately to complete your frame.
▶ Page B24

Tip: Top cap is not included. Use the top cap from the base panel you are stacking on.

Tip: If stacking a window kit, stacking horizontal frame package is not needed.

Tip: Remember to order skins to complete the panel.

Standard Includes	Required to Specify
<ul style="list-style-type: none"> • Cable lay-in tray: black paint only • One horizontal connecting bar: black paint only 	Style number

Specification Information		
• Width	• Style Number	• Price
18"	TS718HFS	\$14
24"	TS724HFS	\$15
30"	TS730HFS	\$16
36"	TS736HFS	\$17
42"	TS742HFS	\$19
48"	TS748HFS	\$21
60"	TS760HFS	\$26
72"	TS772HFS	\$37
:	:	:

Answer

Frame Components

SIN 711.1

Adjustable Brace



Tip: Adjustable brace is required to provide additional support for the segmented skins on 60"W and 72"W panels.

Tip: Adjustable braces are standard in 60"W and 72"W segmented panel packages. One adjustable brace is standard on 60"W and 72"W horizontal frame packages.

Standard Includes	Required to Specify
-------------------	---------------------

- Package of 12 adjustable braces: black paint only

Style number

Specification Information	
•Style Number	•Price
TS7AB	\$127

•Style Number	•Price
TS7AB	\$127

SIN 711.1

Performance Tackable Fabric-Covered Panel Skins

for Panel Buildups

SIN 711.1

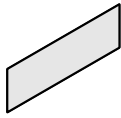



Tip: Remember to order skins for both sides of the panel, a horizontal frame package to complete the panel, junctions to connect adjacent panels and adjustable braces for 60"W and 72"W panels with segmented skins.



Standard Includes	Required to Specify
<ul style="list-style-type: none"> Performance tackable panel skin: fabric price group 1 	1 Style number 2 Fabric color number for skin surface 3 Options, if selected (see below) ▶ See <i>Surface Materials</i> , page B180.

Surface Materials	Options	Price	Required to Specify
	Fabric price group 1	No cost	Specify fabric color number.
	Fabric price group 2		
	<ul style="list-style-type: none"> 12"H skins 24"H skins 36"H to 60"H skins 	+\$ 13 +\$ 17 +\$ 22	Specify fabric color number. Specify fabric color number. Specify fabric color number.
	Fabric price group 3		
	<ul style="list-style-type: none"> 12"H skins 24"H skins 36"H to 60"H skins 	+\$ 22 +\$ 30 +\$ 40	Specify fabric color number. Specify fabric color number. Specify fabric color number.
	Fabric price group 4		
	<ul style="list-style-type: none"> 12"H skins 24"H skins 36"H to 60"H skins 	+\$ 32 +\$ 46 +\$ 64	Specify fabric color number. Specify fabric color number. Specify fabric color number.
	Fabric price group 5		
	<ul style="list-style-type: none"> 12"H skins 24"H skins 36"H to 60"H skins 	+\$ 50 +\$ 72 +\$100	Specify fabric color number. Specify fabric color number. Specify fabric color number.
	Fabric price group COM		
	<ul style="list-style-type: none"> 12"H skins 24"H skins 36"H to 60"H skins 	+\$ 30 +\$ 30 +\$ 30	Specify fabric color number. Specify fabric color number. Specify fabric color number.

Answer

Specification Information

12"H			24"H		36"H	
						
Width	Style Number	Base Price	Style Number	Base Price	Style Number	Base Price
18"	TS71218TA	\$ 66	TS72418TA	\$ 91	TS73618TA	\$137
24"	TS71224TA	\$ 71	TS72424TA	\$ 98	TS73624TA	\$148
30"	TS71230TA	\$ 77	TS72430TA	\$105	TS73630TA	\$159
36"	TS71236TA	\$ 82	TS72436TA	\$112	TS73636TA	\$170
42"	TS71242TA	\$ 87	TS72442TA	\$119	TS73642TA	\$186
48"	TS71248TA	\$ 94	TS72448TA	\$129	TS73648TA	\$218
60"	TS71260TA	\$106	TS72460TA	\$146	TS73660TA	\$249
72"	TS71272TA	\$118	TS72472TA	\$163	TS73672TA	\$276
:	:	:	:	:	:	:

48"H			60"H	
				
Width	Style Number	Base Price	Style Number	Base Price
18"	TS74818TA	\$145	TS76018TA	\$175
24"	TS74824TA	\$156	TS76024TA	\$186
30"	TS74830TA	\$166	TS76030TA	\$197
36"	TS74836TA	\$177	TS76036TA	\$207
42"	TS74842TA	\$193	TS76042TA	\$224
48"	TS74848TA	\$226	TS76048TA	\$256
60"	TS74860TA	\$260	TS76060TA	\$288
72"	TS74872TA	\$287	TS76072TA	\$314
:	:	:	:	:

Tackable Fabric-Covered Panel Skins

for Panel Buildups

SIN 711.1

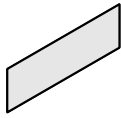





Tip: Remember to order skins for both sides of the panel, a horizontal frame package to complete the panel, junctions to connect adjacent panels and adjustable braces for 60"W and 72"W panels with segmented skins.

Standard Includes		Required to Specify	
<ul style="list-style-type: none"> Tackable panel skin: fabric price group 1 		1 Style number 2 Fabric color number for skin surface 3 Options, if selected (see below) ▶ See <i>Surface Materials</i> , page B180.	

Surface Materials	Options	Price	Required to Specify
	Fabric price group 1	No cost	Specify fabric color number.
	Fabric price group 2		
	<ul style="list-style-type: none"> 12"H skins 24"H skins 36"H to 60"H skins 	+\$ 13 +\$ 17 +\$ 22	Specify fabric color number. Specify fabric color number. Specify fabric color number.
	Fabric price group 3		
	<ul style="list-style-type: none"> 12"H skins 24"H skins 36"H to 60"H skins 	+\$ 22 +\$ 30 +\$ 40	Specify fabric color number. Specify fabric color number. Specify fabric color number.
	Fabric price group 4		
	<ul style="list-style-type: none"> 12"H skins 24"H skins 36"H to 60"H skins 	+\$ 32 +\$ 46 +\$ 64	Specify fabric color number. Specify fabric color number. Specify fabric color number.
	Fabric price group 5		
	<ul style="list-style-type: none"> 12"H skins 24"H skins 36"H to 60"H skins 	+\$ 50 +\$ 72 +\$100	Specify fabric color number. Specify fabric color number. Specify fabric color number.
	Fabric price group COM		
	<ul style="list-style-type: none"> 12"H skins 24"H skins 36"H to 60"H skins 	+\$ 30 +\$ 30 +\$ 30	Specify fabric color number. Specify fabric color number. Specify fabric color number.

Specification Information

12"H			24"H		36"H	
						
Width	Style Number	Base Price	Style Number	Base Price	Style Number	Base Price
18"	TS71218TK	\$ 64	TS72418TK	\$ 87	TS73618TK	\$125
24"	TS71224TK	\$ 69	TS72424TK	\$ 94	TS73624TK	\$134
30"	TS71230TK	\$ 74	TS72430TK	\$101	TS73630TK	\$144
36"	TS71236TK	\$ 78	TS72436TK	\$108	TS73636TK	\$154
42"	TS71242TK	\$ 83	TS72442TK	\$115	TS73642TK	\$169
48"	TS71248TK	\$ 90	TS72448TK	\$124	TS73648TK	\$198
60"	TS71260TK	\$102	TS72460TK	\$140	TS73660TK	\$226
72"	TS71272TK	\$114	TS72472TK	\$157	TS73672TK	\$251
:	:	:	:	:	:	:

48"H			60"H	
				
Width	Style Number	Base Price	Style Number	Base Price
18"	TS74818TK	\$131	TS76018TK	\$159
24"	TS74824TK	\$141	TS76024TK	\$169
30"	TS74830TK	\$151	TS76030TK	\$178
36"	TS74836TK	\$161	TS76036TK	\$188
42"	TS74842TK	\$175	TS76042TK	\$203
48"	TS74848TK	\$205	TS76048TK	\$232
60"	TS74860TK	\$236	TS76060TK	\$262
72"	TS74872TK	\$261	TS76072TK	\$285
:	:	:	:	:

Steel Panel Skins

for Panel Buildups

SIN 711.1

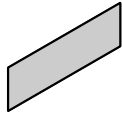

Tip: Remember to order skins for both sides of the panel, a horizontal frame package to complete the panel, and panel-to-panel junctions to connect adjacent panels.

Tip: Steel skins cannot accommodate power receptacles or communication outlets. Use the base or fabric skin for power access.

Tip: Horizontal beam and back of opposite skin is visible through perforated skin.

Standard Includes	Required to Specify
-------------------	---------------------

- Steel panel skin: paint

- 1 Style number
- 2 Paint color number for skin surface
- 3 Options, if selected (see below)
- ▶ See *Surface Materials*, page B180.

Surface Materials	Options	Price	Required to Specify
-------------------	---------	-------	---------------------

Surface Materials	Options	Price	Required to Specify
	Paint price group 1	No cost	Specify paint color number.
	Paint price group 2		
	• 12"H and 24"H skins	+\$ 20	Specify paint color number.
	• 36"H to 60"H skins	+\$ 41	Specify paint color number.
	Paint price group 3		
	• 12"H and 24"H skins	+\$ 35	Specify paint color number.
	• 36"H to 60"H skins	+\$ 69	Specify paint color number.
	Skin surface		
	• Ribbed steel on 12"H and 24"H skins only	+\$18	Specify with <i>ribbed steel</i> .
	• Perforated steel on 12"H and 24"H skins only	Prices below	Specify with <i>perforated steel</i> .

Specification Information

12"H



Width	Style Number	Base Price	Options
			Perforated Steel
18"	TS71218HS	\$49	+\$29
24"	TS71224HS	\$53	+\$31
30"	TS71230HS	\$57	+\$34
36"	TS71236HS	\$61	+\$36
42"	TS71242HS	\$65	+\$38
48"	TS71248HS	\$71	+\$42
60"	TS71260HS	\$80	+\$47
72"	TS71272HS	\$90	+\$53

24"H





Style Number	Base Price	Options
		Perforated Steel
TS72418HS	\$ 79	+\$46
TS72424HS	\$ 85	+\$50
TS72430HS	\$ 92	+\$54
TS72436HS	\$ 98	+\$58
TS72442HS	\$104	+\$61
TS72448HS	\$113	+\$67
TS72460HS	\$129	+\$76
TS72472HS	\$144	+\$85

▶ Specification information continued on next page

▶ Continued from previous page

Specification Information

36"H			48"H		60"H	
						
Width	Style Number	Base Price	Style Number	Base Price	Style Number	Base Price
18"	TS73618HS	\$117	TS74818HS	\$127	TS76018HS	\$149
24"	TS73624HS	\$126	TS74824HS	\$137	TS76024HS	\$159
30"	TS73630HS	\$136	TS74830HS	\$147	TS76030HS	\$168
36"	TS73636HS	\$146	TS74836HS	\$157	TS76036HS	\$178
42"	TS73642HS	\$156				
48"	TS73648HS	\$171				
60"	TS73660HS	\$190				
72"	TS73672HS	\$214				
:	:	:	:	:	:	:

Marker Board Surfaces for Steel Skins

for Panel Buildups

SIN 711.1

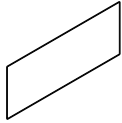

Tip: Remember to order steel skin of the same size to support marker board surface.

▶ Page B54

Standard Includes	Required to Specify
-------------------	---------------------

- Flexible, magnetic marker board panel surface to attach to steel skin: white plastic

Style number

Specification Information						
12"H			24"H		36"H	

12"H			24"H		36"H	
•Width	•Style Number	•Price	•Style Number	•Price	•Style Number	•Price
24"	TS71224MBS	\$70	TS72424MBS	\$ 88	TS73624MBS	\$109
30"	TS71230MBS	\$74	TS72430MBS	\$ 92	TS73630MBS	\$115
36"	TS71236MBS	\$77	TS72436MBS	\$ 96	TS73636MBS	\$121
42"	TS71242MBS	\$81	TS72442MBS	\$101	TS73642MBS	\$127
48"	TS71248MBS	\$85	TS72448MBS	\$106	TS73648MBS	\$133

Slatwall Skins

SIN 711.1

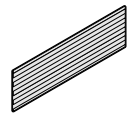

Standard Includes	Required to Specify
-------------------	---------------------

- | | |
|---|---|
| <ul style="list-style-type: none"> • Skin with slatwall channels to accommodate work tools: paint • Attachment hardware | <ul style="list-style-type: none"> 1 Style number 2 Paint color number:
4750 Champagne
4799 Platinum
7207 Black |
|---|---|

Answer

Specification Information				
12"H			24"H	

12"H			24"H	
Width	Style Number	Price	Style Number	Price
24"	TS71224SW	\$191	TS72424SW	\$277
30"	TS71230SW	\$220	TS72430SW	\$308
36"	TS71236SW	\$264	TS72436SW	\$353
42"	TS71242SW	\$279	TS72442SW	\$367
48"	TS71248SW	\$294	TS72448SW	\$382
:	:	:	:	:

Glass Window Kits

for Panel Buildups

SIN 711.1

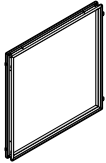



Tip: Window trim is available in 6000 Black, 6654 Sand (Vanadium), and 6697 Fog only.



Standard Includes	Required to Specify
-------------------	---------------------

- Glass window: 6500 Clear Glass
- Frame and trim: plastic

- 1 Style number
 - 2 Color number for glass:
6500 Clear Glass
 - 3 Plastic color number for frame and trim:
6000 Black
6654 Sand (Vanadium)
6697 Fog
- ▶ See *Surface Materials*, page B180.

Specification Information				
---------------------------	--	--	--	--

12"H			24"H	
				
• Width	• Style Number	• Price	• Style Number	• Price
24"	TS71224WG	\$300	TS72424WG	\$ 400
30"	TS71230WG	\$323	TS72430WG	\$ 424
36"	TS71236WG	\$346	TS72436WG	\$ 449
42"	TS71242WG	\$369	TS72442WG	\$ 476
48"	TS71248WG	\$390	TS72448WG	\$ 520
60"	TS71260WG	\$450	N.A.	
72"	TS71272WG	\$504	N.A.	

36"H			48"H	
				
• Width	• Style Number	• Price	• Style Number	• Price
24"	TS73624WG	\$580	TS74824WG	\$ 870
30"	TS73630WG	\$623	TS74830WG	\$ 935
36"	TS73636WG	\$666	TS74836WG	\$1000
42"	TS73642WG	\$709	TS74842WG	\$1065
48"	TS73648WG	\$754	TS74848WG	\$1131

Pass-Thru Window Kits

for Panel Buildups

SIN 711.1

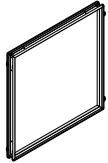

Tip: Window trim is available in 6000 Black, 6654 Sand (Vanadium), and 6697 Fog only.



Standard Includes	Required to Specify
-------------------	---------------------

- Pass-thru window
- Frame and trim: plastic

- 1 Style number
 - 2 Plastic color number for frame and trim:
 - 6000 Black
 - 6654 Sand (Vanadium)
 - 6697 Fog
- ▶ See *Surface Materials*, page B180.

Answer

Specification Information

12"H			24"H	
				
Width	Style Number	Price	Style Number	Price
24"	TS71224WP	\$198	TS72424WP	\$264
30"	TS71230WP	\$213	TS72430WP	\$280
36"	TS71236WP	\$228	TS72436WP	\$296
42"	TS71242WP	\$243	TS72442WP	\$314
48"	TS71248WP	\$257	TS72448WP	\$343
60"	TS71260WP	\$302	N.A.	
72"	TS71272WP	\$338	N.A.	

36"H		
		
Width	Style Number	Price
24"	TS73624WP	\$383
30"	TS73630WP	\$411
36"	TS73636WP	\$440
42"	TS73642WP	\$468
48"	TS73648WP	\$498

Glass Windows

for Panel Buildups

SIN 711.1

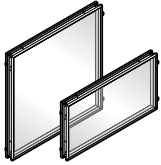



Standard Includes	Required to Specify
<ul style="list-style-type: none"> • Single-pane glass window, if selected: 6500 Clear Glass • Double-pane glass window, if selected: 6530 Frosted Glass • Frame: paint 	<ul style="list-style-type: none"> 1 Style number 2 Paint color number for frame 3 Options, if selected (see below) <p>▶ See <i>Surface Materials</i>, page B180.</p>



Surface Materials	Options	Price	Required to Specify
	Frame <ul style="list-style-type: none"> • Paint price group 1 • Paint price group 2 • Paint price group 3 	No cost +\$ 20 +\$ 35	Specify paint color number. Specify paint color number. Specify paint color number.
	Single-pane glass window <ul style="list-style-type: none"> • Frosted glass in 12"H window • Frosted glass in 24"H window 	+\$ 50 +\$100	Specify with 6530 Frosted Glass. Specify with 6530 Frosted Glass.

Specification Information

Single Pane

12"H			24"H	
				
• Width	• Style Number	• Base Price	• Style Number	• Base Price
24"	TS71224SPW	\$330	TS72424SPW	\$440
30"	TS71230SPW	\$355	TS72430SPW	\$466
36"	TS71236SPW	\$381	TS72436SPW	\$494
42"	TS71242SPW	\$406	TS72442SPW	\$524
48"	TS71248SPW	\$429	TS72448SPW	\$572
60"	TS71260SPW	\$495	TS72460SPW	\$638
72"	TS71272SPW	\$554	N.A.	

Double Pane

12"H			24"H	
				
• Width	• Style Number	• Base Price	• Style Number	• Base Price
24"	TS71224DPW	\$363	TS72424DPW	\$484
30"	TS71230DPW	\$391	TS72430DPW	\$513
36"	TS71236DPW	\$419	TS72436DPW	\$543
42"	TS71242DPW	\$446	TS72442DPW	\$576
48"	TS71248DPW	\$472	TS72448DPW	\$629
60"	TS71260DPW	\$545	TS72460DPW	\$702
72"	TS71272DPW	\$610	N.A.	

Single-Pane Glass Window Kits for Use with Custom Glass

for Panel Buildups

SIN 711.1

Single-Pane
Glass Window Kits
for Use with
Custom Glass

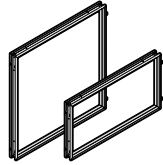

Tip: Custom glass must be ordered separately.

▶ See below for the dimensions of custom inserts.

Tip: Glass window kits are available for single pane only.

Standard Includes	Required to Specify
<ul style="list-style-type: none"> • Frame: paint 	1 Style number 2 Paint color number for frame 3 Options, if selected (see below) ▶ See <i>Surface Materials</i> , page B180.

Options	Price	Required to Specify
Surface Materials <ul style="list-style-type: none"> • Paint price group 1 • Paint price group 2 • Paint price group 3 	No cost +\$20 +\$35	Specify paint color number. Specify paint color number. Specify paint color number.

Specification Information

Single Pane				
12"H			24"H	
Width	Style Number	Base Price	Style Number	Base Price
24"	TS71224SCW	\$257	TS72424SCW	\$343
30"	TS71230SCW	\$276	TS72430SCW	\$363
36"	TS71236SCW	\$296	TS72436SCW	\$384
42"	TS71242SCW	\$315	TS72442SCW	\$408
48"	TS71248SCW	\$334	TS72448SCW	\$445
60"	TS71260SCW	\$392	TS72460SCW	\$494
72"	TS71272SCW	\$439	N.A.	

Sizes for Field-Installed, Single-Pane Custom Glass Inserts

Frame Size	Style Number	Height	Width	Thickness
12"H	24"W TS71224SCW	9.760"	21.280"	0.236"
	30"W TS71230SCW	9.760"	27.280"	0.236"
	36"W TS71236SCW	9.760"	33.280"	0.236"
	42"W TS71242SCW	9.760"	39.280"	0.236"
	48"W TS71248SCW	9.760"	45.280"	0.236"
	60"W TS71260SCW	9.760"	57.280"	0.236"
	72"W TS71272SCW	9.760"	69.280"	0.236"
24"H	24"W TS72424SCW	22.120"	21.280"	0.236"
	30"W TS72430SCW	22.120"	27.280"	0.236"
	36"W TS72436SCW	22.120"	33.280"	0.236"
	42"W TS72442SCW	22.120"	39.280"	0.236"
	48"W TS72448SCW	22.120"	45.280"	0.236"
	60"W TS72460SCW	22.120"	57.280"	0.236"

Answer

Panel Top Screens

12"H

SIN 711.1

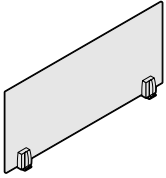

Standard Includes	Required to Specify
-------------------	---------------------

- Screen: 6625 Translucent
- Supports: 6623 Metallic

Style number

Specification Information		
Width	Style Number	Price
30"	TS71230PTS	\$124
36"	TS71236PTS	\$130
42"	TS71242PTS	\$137
48"	TS71248PTS	\$143
:	:	:

Technology Skins

for Panel Buildups

SIN 711.1

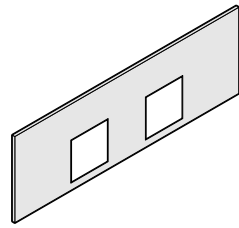

Tip: Remember to order technology covers to fill the pre-cut openings.

Tip: Remember to order skins for both sides of the panel, a horizontal frame package to complete the panel, and panel-to-panel junctions to connect adjacent panels.

Tip: Ribbed steel technology skins cannot be fabric-covered.

Tip: A powerkit must always be located behind the technology skin.

Standard Includes	Required to Specify
<ul style="list-style-type: none"> Technology skin: paint price group 1 	1 Style number 2 Paint color number for skin surface 3 Options, if selected (see below) ▶ See <i>Surface Materials</i> , page B180.

Surface Materials	Options	Price	Required to Specify
	Paint price group 1	No cost	Specify paint color number.
	Paint price group 2	+\$20	Specify paint color number.
	Paint price group 3	+\$35	Specify paint color number.
	Fabric-covered		
	• Fabric price group 1	+\$40	Specify fabric color number.
	• Fabric price group 2	+\$53	Specify fabric color number.
	• Fabric price group 3	+\$62	Specify fabric color number.
	• Fabric price group 4	+\$72	Specify fabric color number.
	• Fabric price group 5	+\$90	Specify fabric color number.
	• Fabric price group COM	+\$70	Specify fabric color number.
	Skin surface		
	• Ribbed steel	+\$18	Specify <i>with ribbed steel</i> .

Specification Information		
Width	Style Number	Base Price
24"	TS71224TS	\$ 85
30"	TS71230TS	\$100
36"	TS71236TS	\$105
42"	TS71242TS	\$110
48"	TS71248TS	\$120
60"	TS71260TS	\$140
72"	TS71272TS	\$150
:	:	:

Answer

Technology Covers

SIN 711.1

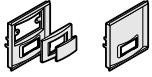

Standard Includes	Required to Specify
<ul style="list-style-type: none"> Technology cover and trim ring: plastic 	<ul style="list-style-type: none"> 1 Style number 2 Plastic color number for technology cover and trim ring: <ul style="list-style-type: none"> 6000 Black 6654 Sand (Vanadium) 6697 Fog

Specification Information

•Style Number	•Price

Power and Communication

TS7PCTC	\$3

Power Only

TS7PTC	\$3



Tip: Receptacle filler to close unused openings is available through Customer Service Parts (891500350MP, package of 20).

SIN 711.1

42"H and 54"H Full Skin Performance Tackable Panel Packages

SIN 711.1

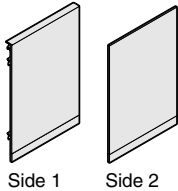

Tip: You must order junctions separately to connect adjacent panels.
▶ Page B24

Tip: Remember to order receptacles and face plates.
▶ Pages B80 and B82

Tip: 18"W panels can accommodate pass-through power only.

Tip: Remember to specify an optional shortened change-of-height top cap on any panel in a change-of-height configuration.
Exception: The tallest panel in the configuration never needs a shortened change-of-height top cap.

Standard Includes	Required to Specify
<ul style="list-style-type: none"> • Full performance tackable skins on both sides of panel: fabric price group 1 • Standard length top cap: color default determined by trim paint color • Base covers: painted steel • Cable lay-in tray • Two horizontal connecting bars 	<ol style="list-style-type: none"> 1 Style number 2 Fabric color number for side 1 3 Fabric color number for side 2 4 Paint color number for trim 5 Options, if selected (see below) <p>▶ See <i>Surface Materials</i>, page B180.</p>

Surface Materials	Options	Price	Required to Specify	
	<ul style="list-style-type: none"> • Paint price group 1 • Paint price group 2 • Paint price group 3 	<ul style="list-style-type: none"> No cost +\$ 11 +\$ 19 	<ul style="list-style-type: none"> Specify paint color number. Specify paint color number. Specify paint color number. 	
	<p>Fabric price group 1</p> <ul style="list-style-type: none"> • 42"H panel skin each side • 54"H panel skin each side 	<ul style="list-style-type: none"> No cost No cost 	<ul style="list-style-type: none"> Specify fabric color number. Specify fabric color number. 	
	<p>Fabric price group 2</p> <ul style="list-style-type: none"> • 42"H panel skin each side • 54"H panel skin each side 	<ul style="list-style-type: none"> +\$ 22 +\$ 22 	<ul style="list-style-type: none"> Specify fabric color number. Specify fabric color number. 	
	<p>Fabric price group 3</p> <ul style="list-style-type: none"> • 42"H panel skin each side • 54"H panel skin each side 	<ul style="list-style-type: none"> +\$ 40 +\$ 40 	<ul style="list-style-type: none"> Specify fabric color number. Specify fabric color number. 	
	<p>Fabric price group 4</p> <ul style="list-style-type: none"> • 42"H panel skin each side • 54"H panel skin each side 	<ul style="list-style-type: none"> +\$ 64 +\$ 64 	<ul style="list-style-type: none"> Specify fabric color number. Specify fabric color number. 	
	<p>Fabric price group 5</p> <ul style="list-style-type: none"> • 42"H panel skin each side • 54"H panel skin each side 	<ul style="list-style-type: none"> +\$100 +\$100 	<ul style="list-style-type: none"> Specify fabric color number. Specify fabric color number. 	
	<p>Fabric price group COM</p> <ul style="list-style-type: none"> • 42"H panel skin each side • 54"H panel skin each side 	<ul style="list-style-type: none"> +\$ 30 +\$ 30 	<ul style="list-style-type: none"> Specify fabric color number. Specify fabric color number. 	
	<p>Top cap</p> <ul style="list-style-type: none"> • Wood • Customiz stain on wood 	<ul style="list-style-type: none"> Prices at right +\$ 13 	<ul style="list-style-type: none"> Specify <i>with wood top cap</i> and select wood color number. Specify <i>with Customiz stain</i>. 	
	<p>Change-of-Height Shortened Top Cap</p>	<ul style="list-style-type: none"> • Change-of-height at one end of top cap • Change-of-height at both ends of top cap on 36"W and wider panels 	<ul style="list-style-type: none"> +\$ 5 +\$ 5 	<ul style="list-style-type: none"> Specify <i>with change-of-height, one end</i>. Specify <i>with change-of-height, both ends</i>.
	<p>Power with 3+1, 2+2, or three separate neutrals (3SN) wiring schematics</p>	<ul style="list-style-type: none"> • One pass-through power harness 18"W to 48"W • One pass-through power harness 60"W or 72"W • One power kit 24"W to 48"W • One power kit 60"W or 72"W 	<ul style="list-style-type: none"> +\$117 +\$130 +\$145 +\$218 	<ul style="list-style-type: none"> Specify <i>with one pass-through harness</i> and indicate wiring schematic type (3+1, 2+2, or 3SN). Specify <i>with one pass-through harness</i> and indicate wiring schematic type (3+1, 2+2, or 3SN). Specify <i>with one power kit</i> and indicate wiring schematic type (3+1, 2+2, or 3SN). Specify <i>with one power kit</i> and indicate wiring schematic type (3+1, 2+2, or 3SN).

Answer

Specification Information

42"H



54"H



Width	Style Number	Base Price	Option	Style Number	Base Price	Option
			(Add \$ to Base Price)			(Add \$ to Base Price)
			Wood Top Cap			Wood Top Cap
18"	TS74218PF	\$304	+\$141	TS75418PF	\$314	+\$141
24"	TS74224PF	\$328	+\$141	TS75424PF	\$344	+\$141
30"	TS74230PF	\$353	+\$141	TS75430PF	\$367	+\$141
36"	TS74236PF	\$377	+\$141	TS75436PF	\$391	+\$141
42"	TS74242PF	\$414	+\$141	TS75442PF	\$428	+\$141
48"	TS74248PF	\$481	+\$141	TS75448PF	\$497	+\$141
60"	TS74260PF	\$555	+\$189	TS75460PF	\$577	+\$189
72"	TS74272PF	\$631	+\$189	TS75472PF	\$653	+\$189
:	:	:	:	:	:	:

66"H Full Skin Performance Tackable Panel Packages

SIN 711.1

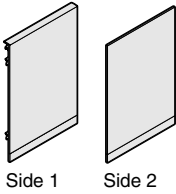

Tip: You must order junctions separately to connect adjacent panels.

▶ Page B24

Tip: Remember to order receptacles and face plates.

▶ Pages B80 and B82

Tip: 18"W panels can accommodate pass-through power only.

Tip: Remember to specify an optional shortened change-of-height top cap on any panel in a change-of-height configuration.

Exception: The tallest panel in the configuration never needs a shortened change-of-height top cap.

Standard Includes		Required to Specify	
<ul style="list-style-type: none"> • Full performance tackable skins on both sides of panel: fabric price group 1 • Standard length top cap: color default determined by trim paint color • Base covers: painted steel • Cable lay-in tray • Two horizontal connecting bars 		<ol style="list-style-type: none"> 1 Style number 2 Fabric color number for side 1 3 Fabric color number for side 2 4 Paint color number for trim 5 Options, if selected (see below) <p>▶ See <i>Surface Materials</i>, page B180.</p>	
Options	Price	Required to Specify	
Surface Materials	<ul style="list-style-type: none"> • Paint price group 1 • Paint price group 2 • Paint price group 3 	<ul style="list-style-type: none"> No cost +\$ 11 +\$ 19 	<ul style="list-style-type: none"> Specify paint color number. Specify paint color number. Specify paint color number.
	Fabric price group 1		
	• 66"H panel skin each side	No cost	Specify fabric color number.
	Fabric price group 2		
	• 66"H panel skin each side	+\$ 22	Specify fabric color number.
	Fabric price group 3		
	• 66"H panel skin each side	+\$ 40	Specify fabric color number.
	Fabric price group 4		
	• 66"H panel skin each side	+\$ 64	Specify fabric color number.
	Fabric price group 5		
	• 66"H panel skin each side	+\$100	Specify fabric color number.
	Fabric price group COM		
	• 66"H panel skin each side	+\$ 30	Specify fabric color number.
	Top cap		
	• Wood	Prices at right	Specify <i>with wood top cap</i> and select wood color number.
	• Customiz stain on wood	+\$ 13	Specify <i>with Customiz stain</i> .
	Change-of-Height Shortened Top Cap		
	• Change-of-height at one end of top cap	+\$ 5	Specify <i>with change-of-height, one end</i> .
	• Change-of-height at both ends of top cap on 36"W and wider panels	+\$ 5	Specify <i>with change-of-height, both ends</i> .
	Power with 3+1, 2+2, or three separate neutrals (3SN) wiring schematics		
	• One pass-through power harness 18"W to 48"W	+\$117	Specify <i>with one pass-through harness</i> and indicate wiring schematic type (3+1, 2+2, or 3SN).
	• One pass-through power harness 60"W or 72"W	+\$130	Specify <i>with one pass-through harness</i> and indicate wiring schematic type (3+1, 2+2, or 3SN).
	• One power kit 24"W to 48"W	+\$145	Specify <i>with one power kit</i> and indicate wiring schematic type (3+1, 2+2, or 3SN).
	• One power kit 60"W or 72"W	+\$218	Specify <i>with one power kit</i> and indicate wiring schematic type (3+1, 2+2, or 3SN).

Specification Information

66"H



Width	Style Number	Base Price	Option (Add \$ to Base Price) Wood Top Cap
18"	TS76618PF	\$380	+\$141
24"	TS76624PF	\$404	+\$141
30"	TS76630PF	\$429	+\$141
36"	TS76636PF	\$451	+\$141
42"	TS76642PF	\$490	+\$141
48"	TS76648PF	\$557	+\$141
60"	TS76660PF	\$633	+\$189
72"	TS76672PF	\$707	+\$189
:	:	:	:

Answer

42"H and 54"H Full Skin Tackable Panel Packages

SIN 711.1

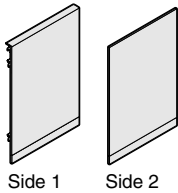

Tip: You must order junctions separately to connect adjacent panels.
▶ Page B24

Tip: Remember to order receptacles and face plates.
▶ Pages B80 and B82

Tip: 18"W panels can accommodate pass-through power only.

Tip: Remember to specify an optional shortened change-of-height top cap on any panel in a change-of-height configuration.
Exception: The tallest panel in the configuration never needs a shortened change-of-height top cap.

Standard Includes	Required to Specify
<ul style="list-style-type: none"> • Full tackable skins on both sides of panel: fabric price group 1 • Standard length top cap: color default determined by trim paint color • Base covers: painted steel • Cable lay-in tray • Two horizontal connecting bars 	<ol style="list-style-type: none"> 1 Style number 2 Fabric color number for side 1 3 Fabric color number for side 2 4 Paint color number for trim 5 Options, if selected (see below) <p>▶ See <i>Surface Materials</i>, page B180.</p>

Surface Materials	Options	Price	Required to Specify
	<ul style="list-style-type: none"> • Paint price group 1 • Paint price group 2 • Paint price group 3 	<ul style="list-style-type: none"> No cost +\$ 11 +\$ 19 	<ul style="list-style-type: none"> Specify paint color number. Specify paint color number. Specify paint color number.
	<p>Fabric price group 1</p> <ul style="list-style-type: none"> • 42"H panel skin each side • 54"H panel skin each side 	<ul style="list-style-type: none"> No cost No cost 	<ul style="list-style-type: none"> Specify fabric color number. Specify fabric color number.
	<p>Fabric price group 2</p> <ul style="list-style-type: none"> • 42"H panel skin each side • 54"H panel skin each side 	<ul style="list-style-type: none"> +\$ 22 +\$ 22 	<ul style="list-style-type: none"> Specify fabric color number. Specify fabric color number.
	<p>Fabric price group 3</p> <ul style="list-style-type: none"> • 42"H panel skin each side • 54"H panel skin each side 	<ul style="list-style-type: none"> +\$ 40 +\$ 40 	<ul style="list-style-type: none"> Specify fabric color number. Specify fabric color number.
	<p>Fabric price group 4</p> <ul style="list-style-type: none"> • 42"H panel skin each side • 54"H panel skin each side 	<ul style="list-style-type: none"> +\$ 64 +\$ 64 	<ul style="list-style-type: none"> Specify fabric color number. Specify fabric color number.
	<p>Fabric price group 5</p> <ul style="list-style-type: none"> • 42"H panel skin each side • 54"H panel skin each side 	<ul style="list-style-type: none"> +\$100 +\$100 	<ul style="list-style-type: none"> Specify fabric color number. Specify fabric color number.
	<p>Fabric price group COM</p> <ul style="list-style-type: none"> • 42"H panel skin each side • 54"H panel skin each side 	<ul style="list-style-type: none"> +\$ 30 +\$ 30 	<ul style="list-style-type: none"> Specify fabric color number. Specify fabric color number.
	<p>Top cap</p> <ul style="list-style-type: none"> • Wood • Customiz stain on wood 	<ul style="list-style-type: none"> Prices at right +\$ 13 	<ul style="list-style-type: none"> Specify <i>with wood top cap</i> and select wood color number. Specify <i>with Customiz stain</i>.
	<p>Change-of-Height Shortened Top Cap</p> <ul style="list-style-type: none"> • Change-of-height at one end of top cap • Change-of-height at both ends of top cap on 36"W and wider panels 	<ul style="list-style-type: none"> +\$ 5 +\$ 5 	<ul style="list-style-type: none"> Specify <i>with change-of-height, one end</i>. Specify <i>with change-of-height, both ends</i>.
	<p>Power with 3+1, 2+2, or three separate neutrals (3SN) wiring schematics</p> <ul style="list-style-type: none"> • One pass-through power harness 18"W to 48"W • One pass-through power harness 60"W or 72"W • One power kit 24"W to 48"W • One power kit 60"W or 72"W 	<ul style="list-style-type: none"> +\$117 +\$130 +\$145 +\$218 	<ul style="list-style-type: none"> Specify <i>with one pass-through harness</i> and indicate wiring schematic type (3+1, 2+2, or 3SN). Specify <i>with one pass-through harness</i> and indicate wiring schematic type (3+1, 2+2, or 3SN). Specify <i>with one power kit</i> and indicate wiring schematic type (3+1, 2+2, or 3SN). Specify <i>with one power kit</i> and indicate wiring schematic type (3+1, 2+2, or 3SN).

Specification Information

42"H



54"H

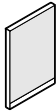

Width	Style Number	Base Price	Option	Style Number	Base Price	Option
			(Add \$ to Base Price)			(Add \$ to Base Price)
			Wood Top Cap			Wood Top Cap
18"	TS74218TF	\$280	+\$141	TS75418TF	\$292	+\$141
24"	TS74224TF	\$300	+\$141	TS75424TF	\$314	+\$141
30"	TS74230TF	\$323	+\$141	TS75430TF	\$337	+\$141
36"	TS74236TF	\$345	+\$141	TS75436TF	\$359	+\$141
42"	TS74242TF	\$380	+\$141	TS75442TF	\$392	+\$141
48"	TS74248TF	\$441	+\$141	TS75448TF	\$455	+\$141
60"	TS74260TF	\$509	+\$189	TS75460TF	\$529	+\$189
72"	TS74272TF	\$581	+\$189	TS75472TF	\$601	+\$189

66"H Full Skin Tackable Panel Packages

SIN 711.1

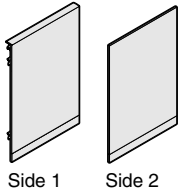

Tip: You must order junctions separately to connect adjacent panels.
▶ Page B24

Tip: Remember to order receptacles and face plates.
▶ Pages B80 and B82

Tip: 18"W panels can accommodate pass-through power only.

Tip: Remember to specify an optional shortened change-of-height top cap on any panel in a change-of-height configuration.
Exception: The tallest panel in the configuration never needs a shortened change-of-height top cap.

Standard Includes		Required to Specify	
<ul style="list-style-type: none"> • Full tackable skins on both sides of panel: fabric price group 1 • Standard length top cap: color default determined by trim paint color • Base covers: painted steel • Cable lay-in tray • Two horizontal connecting bars 		<ol style="list-style-type: none"> 1 Style number 2 Fabric color number for side 1 3 Fabric color number for side 2 4 Paint color number for trim 5 Options, if selected (see below) <p>▶ See <i>Surface Materials</i>, page B180.</p>	
Options	Price	Required to Specify	
Surface Materials	<ul style="list-style-type: none"> • Paint price group 1 • Paint price group 2 • Paint price group 3 	<ul style="list-style-type: none"> No cost +\$ 11 +\$ 19 	<ul style="list-style-type: none"> Specify paint color number. Specify paint color number. Specify paint color number.
	Fabric price group 1		
	• 66"H panel skin each side	No cost	Specify fabric color number.
	Fabric price group 2		
	• 66"H panel skin each side	+\$ 22	Specify fabric color number.
	Fabric price group 3		
	• 66"H panel skin each side	+\$ 40	Specify fabric color number.
	Fabric price group 4		
	• 66"H panel skin each side	+\$ 64	Specify fabric color number.
	Fabric price group 5		
	• 66"H panel skin each side	+\$100	Specify fabric color number.
	Fabric price group COM		
	• 66"H panel skin each side	+\$ 30	Specify fabric color number.
	Top cap		
	• Wood	Prices at right	Specify <i>with wood top cap</i> and select wood color number.
	• Customiz stain on wood	+\$ 13	Specify <i>with Customiz stain</i> .
	Change-of-Height Shortened Top Cap		
	• Change-of-height at one end of top cap	+\$ 5	Specify <i>with change-of-height, one end</i> .
	• Change-of-height at both ends of top cap on 36"W and wider panels	+\$ 5	Specify <i>with change-of-height, both ends</i> .
	Power with 3+1, 2+2, or three separate neutrals (3SN) wiring schematics		
	• One pass-through power harness 18"W to 48"W	+\$117	Specify <i>with one pass-through harness</i> and indicate wiring schematic type (3+1, 2+2, or 3SN).
	• One pass-through power harness 60"W or 72"W	+\$130	Specify <i>with one pass-through harness</i> and indicate wiring schematic type (3+1, 2+2, or 3SN).
	• One power kit 24"W to 48"W	+\$145	Specify <i>with one power kit</i> and indicate wiring schematic type (3+1, 2+2, or 3SN).
	• One power kit 60"W or 72"W	+\$218	Specify <i>with one power kit</i> and indicate wiring schematic type (3+1, 2+2, or 3SN).

Specification Information

66"H



Width	Style Number	Base Price	Option (Add \$ to Base Price)
18"	TS76618TF	\$348	+\$141
24"	TS76624TF	\$370	+\$141
30"	TS76630TF	\$391	+\$141
36"	TS76636TF	\$413	+\$141
42"	TS76642TF	\$448	+\$141
48"	TS76648TF	\$509	+\$141
60"	TS76660TF	\$581	+\$189
72"	TS76672TF	\$649	+\$189
:	:	:	:

Answer

Buttress

SIN 711.1

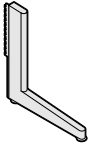

Standard Includes	Required to Specify
<ul style="list-style-type: none"> • Buttress: paint price group 1 	1 Style number 2 Paint color number for buttress 3 Options, if selected (see below) ▶ See <i>Surface Materials</i> , page B180.

	Options	Price	Required to Specify
Surface Materials	• Paint price group 1	No cost	Specify paint color number.
	• Paint price group 2	+\$11	Specify paint color number.
	• Paint price group 3	+\$19	Specify paint color number.

Specification Information	
• Style Number	• Base Price
CBUTTRESSL	\$248
CBUTTRESSR	\$248
:	:

Fence Connectors

SIN 711.1

Tip: Refer to Pathways Post and Beam Solutions Specification Guide for post and beam information.

Standard Includes	Required to Specify
-------------------	---------------------

- Fence connector: 8043 Clear Anodized aluminum
- Post top cap: 6694 Slate plastic

Style number

Specification Information	
---------------------------	--

Style Number	Price
--------------	-------

Left-Hand Fence Connector

CFENCELC	\$90
-----------------	------

Right-Hand Fence Connector

CFENCERC	\$90
-----------------	------

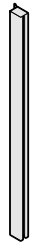

Panel Wiring and Cabling

SIN 711.1

Cable Trays

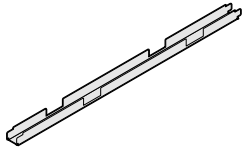

Tip: One cable tray is standard with every panel.

Tip: Cables may also be routed in top of power kit.

Standard Includes	Required to Specify
<ul style="list-style-type: none"> Cable tray: black paint only 	Style number

Specification Information

Width	Height	Style Number	Price
18"	2"	TS718CT	\$17
24"	2"	TS724CT	\$20
30"	2"	TS730CT	\$22
36"	2"	TS736CT	\$27
42"	2"	TS742CT	\$30
48"	2"	TS748CT	\$35
60"	2"	TS760CT	\$39
72"	2"	TS772CT	\$46
:	:	:	:

Powerkits

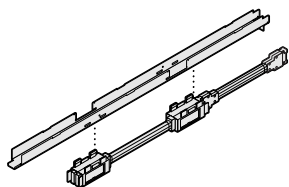

Tip: Remember to order receptacles and face plates.
 ▶ Pages B80 and B82

Standard Includes	Required to Specify
-------------------	---------------------

- Powerkit to accommodate modular receptacles on both sides: black plastic
- Supporting powertray: black paint

Style number

Specification Information			
Width	Number of Duplex Receptacles Accommodated Per Side	Style Number	Price

Width	Number of Duplex Receptacles Accommodated Per Side	Style Number	Price
-------	--	--------------	-------

4-Circuit, 3+1 Wiring Schematic

24"	1	TS7PK24X	\$145
30"	2	TS7PK30X	\$145
36"	2	TS7PK36X	\$145
42"	2	TS7PK42X	\$145
48"	2	TS7PK48X	\$145
60"	4	TS7PK60X	\$218
72"	4	TS7PK72X	\$218
:	:	:	:

4-Circuit, 2+2 Wiring Schematic

24"	1	TS7PK24Y	\$145
30"	2	TS7PK30Y	\$145
36"	2	TS7PK36Y	\$145
42"	2	TS7PK42Y	\$145
48"	2	TS7PK48Y	\$145
60"	4	TS7PK60Y	\$218
72"	4	TS7PK72Y	\$218
:	:	:	:

3-Circuit, Separate Neutrals (3SN) Wiring Schematic

24"	1	TS7PK24Z	\$145
30"	2	TS7PK30Z	\$145
36"	2	TS7PK36Z	\$145
42"	2	TS7PK42Z	\$145
48"	2	TS7PK48Z	\$145
60"	4	TS7PK60Z	\$218
72"	4	TS7PK72Z	\$218
:	:	:	:

Panel Wiring and Cabling, continued

SIN 711.1

Pass-Through Powerkits

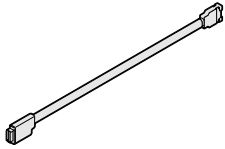

Standard Includes	Required to Specify
<ul style="list-style-type: none"> • Harness with modular connectors 	Style number

Specification Information

• Width	• Style Number	• Price
---------	----------------	---------

4-Circuit, 3+1 Wiring Schematic

18"	TS7PT18X	\$117
24"	TS7PT24X	\$117
30"	TS7PT30X	\$117
36"	TS7PT36X	\$117
42"	TS7PT42X	\$117
48"	TS7PT48X	\$117
60"	TS7PT60X	\$130
72"	TS7PT72X	\$130

4-Circuit, 2+2 Wiring Schematic

18"	TS7PT18Y	\$117
24"	TS7PT24Y	\$117
30"	TS7PT30Y	\$117
36"	TS7PT36Y	\$117
42"	TS7PT42Y	\$117
48"	TS7PT48Y	\$117
60"	TS7PT60Y	\$130
72"	TS7PT72Y	\$130

3-Circuit, Separate Neutrals (3SN) Wiring Schematic

18"	TS7PT18Z	\$117
24"	TS7PT24Z	\$117
30"	TS7PT30Z	\$117
36"	TS7PT36Z	\$117
42"	TS7PT42Z	\$117
48"	TS7PT48Z	\$117
60"	TS7PT60Z	\$130
72"	TS7PT72Z	\$130

SIN 711.1

Panel Wiring and Cabling, continued

SIN 711.1

Duplex Receptacles

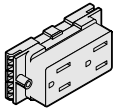

Standard Includes	Required to Specify
<ul style="list-style-type: none"> Receptacle: plastic 	1 Style number 2 Plastic color number for receptacle: 6000 Black 6651 Tungsten 6652 Titanium 6654 Sand (Vanadium) 6697 Fog

Specification Information

Description	Style Number	Price	Style Number	Price
-------------	--------------	-------	--------------	-------

15-Amp Receptacles	20-Amp Receptacles
---------------------------	---------------------------

4-Circuit, 3+1 Wiring Schematic

System Ground				
Line 1	TS71SSX	\$31	ZB1R1SGH	\$47
Line 2	TS72SSX	\$31	ZB1R2SGH	\$47
Line 3	TS73SSX	\$31	ZB1R3SGH	\$47
Line 4	TS74SSX	\$31	ZB1R4SGH	\$47
Isolated Ground				
Line 1	TS71SGX	\$39	ZB1R1IGH	\$60
Line 2	TS72SGX	\$39	ZB1R2IGH	\$60
Line 3	TS73SGX	\$39	ZB1R3IGH	\$60
Line 4	TS74SGX	\$39	ZB1R4IGH	\$60

4-Circuit, 2+2 Wiring Schematic

System Ground				
Line 1	TS71SSY	\$31	ZB2R1SGH	\$47
Line 2	TS72SSY	\$31	ZB2R2SGH	\$47
Line 3	TS73SSY	\$31	ZB2R3SGH	\$47
Line 4	TS74SSY	\$31	ZB2R4SGH	\$47
Isolated Ground				
Line 1	TS71SGY	\$39	ZB2R1IGH	\$60
Line 2	TS72SGY	\$39	ZB2R2IGH	\$60
Line 3	TS73SGY	\$39	ZB2R3IGH	\$60
Line 4	TS74SGY	\$39	ZB2R4IGH	\$60

SIN 711.1

Specification Information

Description	Style Number	Price	Style Number	Price
15-Amp Receptacles			20-Amp Receptacles	

3-Circuit, Separate Neutrals (3SN) Wiring Schematic

System Ground

Line 1	TS71SSZ	\$31	ZB3R1SGH	\$47
Line 2	TS72SSZ	\$31	ZB3R2SGH	\$47
Line 3	TS73SSZ	\$31	ZB3R3SGH	\$47

Isolated Ground

Line 1	TS71SGZ	\$39	ZB3R1IGH	\$60
Line 2	TS72SGZ	\$39	ZB3R2IGH	\$60
Line 3	TS73SGZ	\$39	ZB3R3IGH	\$60

Answer

Panel Wiring and Cabling, continued

SIN 711.1

Face Plate

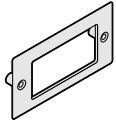

Standard Includes	Required to Specify
<ul style="list-style-type: none"> • One face plate: plastic • Ordered individually 	1 Style number 2 Plastic color number for face plate: 6000 Black 6654 Sand (Vanadium) 6697 Fog

Specification Information

•Style •Number	•Price

Face Plate for Duplex Receptacle and Communications

TS7UFPLATE \$35

Base Power Infeeds

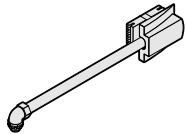

Tip: Power infeed occupies one receptacle location on powerkit.

Standard Includes	Required to Specify
<ul style="list-style-type: none"> • Power infeed cover: plastic • 1/2"-diameter conduit: black plastic only 	1 Style number 2 Plastic color number for power infeed assembly cover: 6000 Black 6654 Sand (Vanadium) 6697 Fog

Specification Information

•Length	•Style •Number	•Price

4-Circuit, 3+1 Wiring Schematic

6'	TS76BPX	\$182
12'	TS712BPX	\$195

4-Circuit, 2+2 Wiring Schematic

6'	TS76BPY	\$182
12'	TS712BPY	\$195

3-Circuit, Separate Neutrals (3SN) Wiring Schematic

6'	TS76BPZ	\$182
12'	TS712BPZ	\$195

Base Power Infeeds for Use in New York City



Standard Includes	Required to Specify
<ul style="list-style-type: none"> • Power infeed assembly • 1/2"-diameter conduit • Power infeed tray: black paint only • Power infeed cover: black paint only 	Style number

Specification Information

Corresponding Panel Width	Style Number	Price

4-Circuit, 3+1 Wiring Schematic

24"	TS7BPNY24X	\$182
30"	TS7BPNY30X	\$182
36"	TS7BPNY36X	\$182
42"	TS7BPNY42X	\$182
48"	TS7BPNY48X	\$182
60"	TS7BPNY60X	\$182
72"	TS7BPNY72X	\$182
:	:	:

4-Circuit, 2+2 Wiring Schematic

24"	TS7BPNY24Y	\$182
30"	TS7BPNY30Y	\$182
36"	TS7BPNY36Y	\$182
42"	TS7BPNY42Y	\$182
48"	TS7BPNY48Y	\$182
60"	TS7BPNY60Y	\$182
72"	TS7BPNY72Y	\$182
:	:	:

3-Circuit, Separate Neutrals (3SN) Wiring Schematic

24"	TS7BPNY24Z	\$182
30"	TS7BPNY30Z	\$182
36"	TS7BPNY36Z	\$182
42"	TS7BPNY42Z	\$182
48"	TS7BPNY48Z	\$182
60"	TS7BPNY60Z	\$182
72"	TS7BPNY72Z	\$182
:	:	:

Panel Wiring and Cabling, continued

SIN 711.1

Hardwired Powerkits

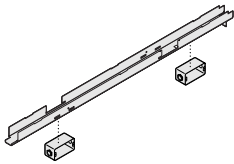

Standard Includes	Required to Specify
<ul style="list-style-type: none"> • Power tray • Junction box(es) • Cover plate(s) 	Style number

Specification Information

Corresponding Panel Width	Number of Junction Boxes	Style Number	Price
24"	1	TS7CPK24	\$145
30"	2	TS7CPK30	\$145
36"	2	TS7CPK36	\$145
42"	2	TS7CPK42	\$145
48"	2	TS7CPK48	\$145
60"	2	TS7CPK60	\$218
72"	2	TS7CPK72	\$218
⋮	⋮	⋮	⋮

Multipurpose Power Infeed



Tip: Utility poles must be specified separately.
 ▶ Page B41

Standard Includes	Required to Specify
<ul style="list-style-type: none"> • Multipurpose power infeed with modular connector • Insulated color-coded wires for hardwired connection to building power source 	Style number

Specification Information

Length	Style Number	Price
⋮	⋮	⋮

4-Circuit, 3+1 Wiring Schematic

12'	TS712UPHX	\$234
24'	TS724UPHX	\$338
⋮	⋮	⋮

4-Circuit, 2+2 Wiring Schematic

12'	TS712UPHY	\$234
24'	TS724UPHY	\$338
⋮	⋮	⋮

3-Circuit, Separate Neutrals (3SN) Wiring Schematic

12'	TS712UPHZ	\$234
24'	TS724UPHZ	\$338
⋮	⋮	⋮

Modular Harnesses

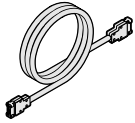

Standard Includes	Required to Specify
<ul style="list-style-type: none"> Conduit with two modular connectors: black 	Style number

Specification Information

Length	Style Number	Price

4-Circuit, 3+1 Wiring Schematic

43"	TS743MHX	\$ 91
80"	TS780MHX	\$130

4-Circuit, 2+2 Wiring Schematic

43"	TS743MHY	\$ 91
80"	TS780MHY	\$130

3-Circuit, Separate Neutrals (3SN) Wiring Schematic

43"	TS743MHZ	\$ 91
80"	TS780MHZ	\$130

Lay-In Junction Cable Sleeve

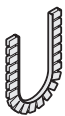

Standard Includes	Required to Specify
<ul style="list-style-type: none"> 5' roll of lay-in junction cable sleeve 	Style number

Specification Information

Style Number	Price
TS7LSLVE	\$69

Panel Wiring and Cabling, continued

SIN 711.1

Feed-Through Horizontal Cable Sleeve



Standard Includes		Required to Specify
<ul style="list-style-type: none"> Package of 25: black plastic 		Style number
Specification Information		
Style Number	Price	
TS7FSLVE	\$69	

Grommet for Horizontal Bar and Junction

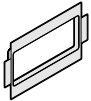

Tip: Grommets can be used on power trays and cable trays.

Standard Includes		Required to Specify
<ul style="list-style-type: none"> Package of 25: black plastic 		Style number
Specification Information		
Style Number	Price	
TS7HSLVE	\$69	

Grommet for Junction



Standard Includes		Required to Specify
<ul style="list-style-type: none"> Package of 25: black plastic only 		Style number
Specification Information		
Style Number	Price	
TS7JSLVE	\$69	

Series 9000 Duplex Cable Grommet

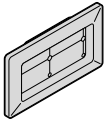

Standard Includes	Required to Specify
<ul style="list-style-type: none"> • Carton of five cable grommets: black plastic 	Style number

Specification Information

Style Number	Price
98863	\$17

Consolidation Point Locking Door Skins

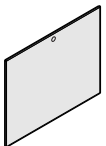

Standard Includes	Required to Specify
<ul style="list-style-type: none"> • Skin: paint price group 1 • Lock, keyed random: 9201 Polished Chrome • Mounting hardware 	1 Style number 2 Paint color number for skin 3 Options, if selected (see below) ▶ See <i>Surface Materials</i> , page B180.

Options	Price	Required to Specify
Surface Materials <ul style="list-style-type: none"> • Paint price group 1 • Paint price group 2 • Paint price group 3 	No cost +\$ 6 +\$11	Specify paint color number. Specify paint color number. Specify paint color number.
Keying <ul style="list-style-type: none"> • Factory- and field-installed keying 		▶ Page B186

Specification Information

Dimensions		Style Number	Base Price
W	H		
30"	24"	TS730CP	\$264
36"	24"	TS736CP	\$297

Panel Wiring and Cabling, continued

SIN 711.1

Consolidation Point Kit

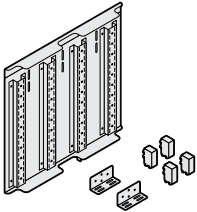

Standard Includes		Required to Specify
<ul style="list-style-type: none"> • Back panel: black paint • Mounting hardware • Two pairs of consolidation point mounting brackets: black only • Two cable managers: black only 		Style number
Specification Information		
• Style Number	• Price	
TS7CPK	\$249	

Consolidation Point Mounting Brackets

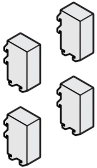

Tip: Order these mounting brackets to meet additional cabling needs when necessary.

Standard Includes		Required to Specify
<ul style="list-style-type: none"> • Carton of two pairs of mounting brackets: black only 		Style number
Specification Information		
• Style Number	• Price	
TS7CPMB	\$46	

Consolidation Point Cable Manager



Tip: Order these cable managers to meet additional cabling needs when necessary.

Standard Includes		Required to Specify
<ul style="list-style-type: none"> • Two cable managers: black only 		Style number
Specification Information		
• Style Number	• Price	
TS7CPCM	\$43	

Ceiling-Access Lay-In Utility Package

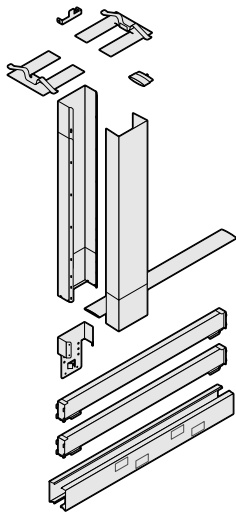

Tip: Order power harness separately.
 ▶ Page B84

Standard Includes	Required to Specify
<ul style="list-style-type: none"> Utility carrier and cover, one top cap, and two standard base trims: paint Two lay-in horizontal connecting bars: black paint only Ceiling attachment hardware Junction cap for end-of-run applications: plastic 	<ol style="list-style-type: none"> Style number Paint color number for utility carrier and cover, top cap, and base trim Plastic color number for junction cap Options, if selected (see below) ▶ See <i>Surface Materials</i> , page B180.

Options	Price	Required to Specify
Surface Materials <ul style="list-style-type: none"> Paint price group 1 Paint price group 2 Paint price group 3 	No cost +\$11 +\$19	Specify paint color number. Specify paint color number. Specify paint color number.
Top cap <ul style="list-style-type: none"> Wood Customiz stain on wood 	Prices below +\$13	Specify <i>with wood top cap</i> and select wood color number. Specify <i>with Customiz stain</i> .
Change-of-Height Shortened Top Cap <ul style="list-style-type: none"> Change-of-height cable routing at one end of top cap 	+\$ 5	Specify <i>with change-of-height, one end</i> .

Specification Information			
Width	Style Number	Base Price	Option (Add \$ to Base Price)
30"	TS730SUC	\$575	Wood Top Cap +\$134
36"	TS736SUC	\$610	Wood Top Cap +\$134
42"	TS742SUC	\$664	Wood Top Cap +\$134
48"	TS748SUC	\$724	Wood Top Cap +\$134
:	:	:	:

Panel Wiring and Cabling, continued

SIN 711.1

Floor-Access Lay-In Utility Package

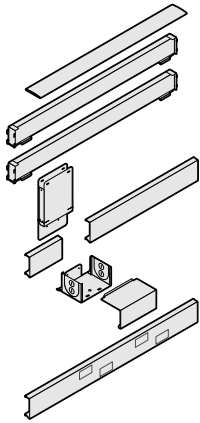

Tip: 30"W lay-in utility package with floor-access is only available with change-of-height shortened top cap at one end.

Tip: Order power harness separately.
▶ Page B84

Standard Includes **Required to Specify**

- One top cap, one standard base trim, one modified base trim, and one base utility box: paint
- Two lay-in horizontal connecting bars: black paint only

- 1 Style number
- 2 Paint color number for top cap, base trim, and base utility box
- 3 Options, if selected (see below)
- ▶ See *Surface Materials*, page B180.

Options **Price** **Required to Specify**

Surface Materials

- Paint price group 1
- Paint price group 2
- Paint price group 3

No cost
+\$11
+\$19

Specify paint color number.
Specify paint color number.
Specify paint color number.

Top cap

- Wood
- Customiz stain on wood

Prices below
+\$13

Specify *with wood top cap* and select wood color number.
Specify *with Customiz stain*.

Change-of-Height Shortened Top Cap

- Change-of-height cable routing at one end of top cap
- Change-of-height cable routing at both ends of top cap on 36", 42", and 48"W packages

+\$ 5
+\$ 5

Specify *with change-of-height, one end*.
Specify *with change-of-height, both ends*.

Specification Information

Width	Style Number	Base Price	Option (Add \$ to Base Price)
30"	TS730SUF	\$350	+\$134
36"	TS736SUF	\$371	+\$134
42"	TS742SUF	\$404	+\$134
48"	TS748SUF	\$441	+\$134
:	:	:	:

Specifying Answer Worksurfaces

► For more detailed product information, see the *Answer Solutions Specification Guide* or consult your Steelcase dealer.

Worksurfaces

Straight Worksurfaces (SIN 711.1)	B92
Transition Worksurfaces (SIN 711.1)	B94
Straight Corner Worksurfaces (SIN 711.1)	B95
Curved Corner Worksurfaces (SIN 711.1)	B96
Straight Corner and Curved Corner Worksurfaces with Adjustable Keyboard Shelf (SIN 711.1)	B97
Extended Curved Corner Worksurfaces (SIN 711.1)	B98
Bridge Worksurfaces (SIN 711.1)	B102
Scoop Worksurface (SIN 711.1)	B103
Wave Worksurfaces (SIN 711.1)	B104
Peninsula and Bullet Peninsula Worksurfaces (SIN 711.1)	B106
Angled Peninsula Worksurfaces (SIN 711.1)	B108
Spanner Worksurfaces (SIN 711.1)	B110
Trapezoid and Spanner Tables (SIN 711.1)	B111
Oval Worksurfaces (SIN 711.1)	B112
Visitor and Curved Linking Worksurfaces (SIN 711.1)	B114
Transaction Countertops (SIN 711.1)	B116
Adjustable-Height Worksurfaces (SIN 711.1)	B117
Angled Peninsula Worksurfaces for Use with Kick (SIN 711.1)	B120
Spanner Worksurfaces for Use with Kick (SIN 711.1)	B121
Curved Linking Worksurfaces for Use with Kick (SIN 711.1)	B122

Worksurface Legs and Supports

B124

End Panels

B126

Worksurface Accessories

Modesty Panels (SIN 711.1)	B127
Pedestal-to-Modesty Panel Filler (SIN 711.1)	B127

Worksurface Wiring and Cabling

Worksurface Wire Manager (SIN 711.1)	B128
Cable Storage Tray (SIN 711.1)	B128
Leg Wire Manager (SIN 711.1)	B128

Straight Worksurfaces

SIN 711.1

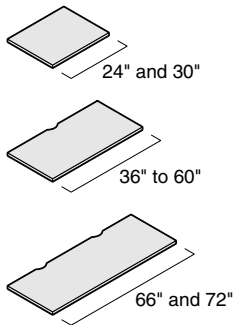

Tip: Reinforcing channel (TS7WKSPT) is available to add support to worksurfaces that have 60" or more of unsupported kneespace and which will be heavily loaded must be ordered separately.
 ▶ Page B125

Standard Includes		Required to Specify
<ul style="list-style-type: none"> • Worksurface: laminate • 3 mm radius profile edge on user's side: vinyl default • Side and back edges: vinyl default • Cable scallops in the back edge 		1 Style number 2 Laminate color number for worksurface 3 Options, if selected (see below) ▶ See <i>Surface Materials</i> , page B180.
Surface Materials	Options	Price
	<ul style="list-style-type: none"> • Wood veneer worksurface with wood edge <ul style="list-style-type: none"> —24" x 24" to 24" x 48" +\$210 —24" x 60" to 30" x 48" +\$250 —30" x 60" to 30" x 72" +\$300 • Customiz stain on wood Prices at right • Full-fill finish Prices at right • Accent laminate +\$ 60 • Open Line laminate +\$ 60 plus cost of laminate 	
		Required to Specify
		Specify <i>with wood worksurface</i> and select wood color number. Specify <i>with Customiz stain</i> . ▶ See <i>Surface Materials Reference Manual</i> . Specify <i>with full-fill finish</i> and select wood color number. ▶ See <i>Surface Materials</i> , page B180. ▶ See <i>Surface Materials Reference Manual</i> . ▶ See <i>Surface Materials Reference Manual</i> .
Related Products	<ul style="list-style-type: none"> • Worksurface legs and supports • Reinforcing channel • Modesty panels • Worksurface wire manager 	▶ Page B124 ▶ Page B125 ▶ Page B127 ▶ Page B128

SIN 711.1

Specification Information				
Depth A	Width B	Style Number	Base Price	Options (Add \$ to Base Price)
24"	24"	TS72424S	\$159	+\$24
24"	30"	TS72430S	\$170	+\$24
24"	36"	TS72436S	\$180	+\$24
24"	42"	TS72442S	\$195	+\$41
24"	48"	TS72448S	\$230	+\$41
24"	60"	TS72460S	\$264	+\$41
24"	66"	TS72466S	\$294	+\$60
24"	72"	TS72472S	\$329	+\$60
30"	24"	TS73024S	\$225	+\$24
30"	30"	TS73030S	\$234	+\$41
30"	36"	TS73036S	\$249	+\$41
30"	42"	TS73042S	\$264	+\$41
30"	48"	TS73048S	\$299	+\$41
30"	60"	TS73060S	\$339	+\$60
30"	66"	TS73066S	\$369	+\$60
30"	72"	TS73072S	\$403	+\$60
:	:	:	:	:

Answer

Transition Worksurfaces

SIN 711.1

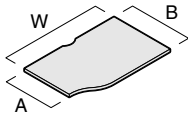

Standard Includes	Required to Specify
-------------------	---------------------

<ul style="list-style-type: none"> • Worksurface: laminate • 3 mm radius profile edge on user's side: vinyl default • Side and back edges: vinyl default • Cable scallops in the back edge 	<ol style="list-style-type: none"> 1 Style number 2 Laminate color number for worksurface 3 Options, if selected (see below) <p>▶ See <i>Surface Materials</i>, page B180.</p>
--	---

Options	Price	Required to Specify
---------	-------	---------------------

<p>Surface Materials</p> <ul style="list-style-type: none"> • Wood veneer worksurface with wood edge <ul style="list-style-type: none"> —24" x 30" x 36" to 24" x 30" x 48" +\$235 —24" x 30" x 60" +\$300 —30" x 24" x 36" to 30" x 24" x 48" +\$235 —30" x 24" x 60" +\$300 • Customiz stain on wood Prices below • Full-fill finish Prices below • Accent laminate +\$ 60 • Open Line laminate +\$ 60 plus cost of laminate 		<p>Specify <i>with wood worksurface</i> and select wood color number.</p> <p>Specify <i>with Customiz stain</i>. ▶ See <i>Surface Materials Reference Manual</i>.</p> <p>Specify <i>with full-fill finish</i> and select wood color number. ▶ See <i>Surface Materials</i>, page B180. ▶ See <i>Surface Materials Reference Manual</i>. ▶ See <i>Surface Materials Reference Manual</i>.</p>
---	--	--

<p>Related Products</p> <ul style="list-style-type: none"> • Worksurface legs and supports • Modesty panels • Worksurface wire manager 	<p>▶ Page B124</p> <p>▶ Page B127</p> <p>▶ Page B128</p>
--	--

Specification Information

Depth A	B	Width	Style Number	Base Price	Options (Add \$ to Base Price)
24"	30"	36"	TS7243036T	\$352	+\$41
24"	30"	42"	TS7243042T	\$370	+\$41
24"	30"	48"	TS7243048T	\$432	+\$41
24"	30"	60"	TS7243060T	\$493	+\$60
30"	24"	36"	TS7302436T	\$352	+\$41
30"	24"	42"	TS7302442T	\$370	+\$41
30"	24"	48"	TS7302448T	\$432	+\$41
30"	24"	60"	TS7302460T	\$493	+\$60
:	:	:	:	:	:

Transition Worksurfaces



Straight Corner Worksurfaces

SIN 711.1

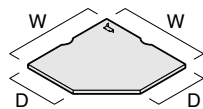

Standard Includes

- Worksurface: laminate
- 3 mm radius profile edge on user's side: vinyl default
- Side and back edges: vinyl default
- Cable scallops in the back edges
- Corner bracket: black paint only

Required to Specify

- 1 Style number
 - 2 Laminate color number for worksurface
 - 3 Options, if selected (see below)
- ▶ See *Surface Materials*, page B180.

Options

Options	Price	Required to Specify
Surface		
• Wood veneer worksurface with wood edge	+\$210	Specify <i>with wood worksurface</i> and select wood color number.
• Customiz stain on wood	+\$ 41	Specify <i>with Customiz stain</i> . ▶ See <i>Surface Materials Reference Manual</i> .
• Full-fill finish	+\$ 41	Specify <i>with full-fill finish</i> and select wood color number. ▶ See <i>Surface Materials</i> , page B180.
• Accent laminate	+\$ 60	▶ See <i>Surface Materials Reference Manual</i> .
• Open Line laminate	+\$ 60 plus cost of laminate	▶ See <i>Surface Materials Reference Manual</i> .

Related Products

- Worksurface legs and supports ▶ Page B124
- Modesty panels ▶ Page B127
- Worksurface wire manager ▶ Page B128

Specification Information

Depth	Width	Style Number	Base Price
24"	36"	TS72436SC	\$284
24"	42"	TS72442SC	\$308
24"	48"	TS72448SC	\$355
30"	42"	TS73042SC	\$355
30"	48"	TS73048SC	\$404

Straight Corner Worksurfaces

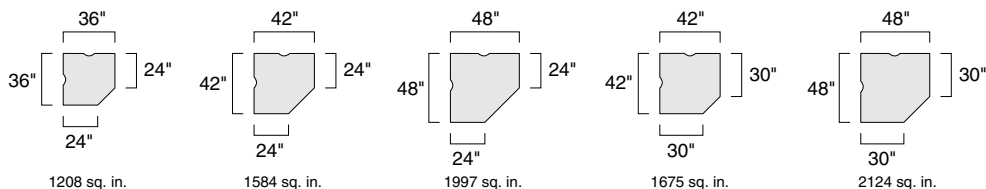

Curved Corner Worksurfaces

SIN 711.1

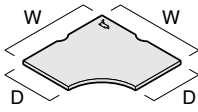

Standard Includes	Required to Specify
-------------------	---------------------

<ul style="list-style-type: none"> • Worksurface: laminate • 3 mm radius profile edge on user's side: vinyl default • Side and back edges: vinyl default • Cable scallops in the back edges • Corner bracket: black paint only 	<ol style="list-style-type: none"> 1 Style number 2 Laminate color number for worksurface 3 Options, if selected (see below) <p>▶ See <i>Surface Materials</i>, page B180.</p>
---	---

Options	Price	Required to Specify
---------	-------	---------------------

Surface Materials	• Wood veneer worksurface with wood edge	+\$225	Specify <i>with wood worksurface</i> and select wood color number. Specify <i>with Customiz stain</i> . ▶ See <i>Surface Materials Reference Manual</i> . Specify <i>with full-fill finish</i> and select wood color number. ▶ See <i>Surface Materials</i> , page B180. ▶ See <i>Surface Materials Reference Manual</i> . ▶ See <i>Surface Materials Reference Manual</i> .
	• Customiz stain on wood	+\$ 41	
	• Full-fill finish	+\$ 41	
	• Accent laminate	+\$ 60	
	• Open Line laminate	+\$ 60 plus cost of laminate	

Related Products	• Worksurface legs and supports	▶ Page B124
	• Modesty panels	▶ Page B127
	• Worksurface wire manager	▶ Page B128

Specification Information

Depth	Width	Style Number	Base Price
24"	36"	TS72436CC	\$349
24"	42"	TS72442CC	\$381
24"	48"	TS72448CC	\$426
30"	42"	TS73042CC	\$417
30"	48"	TS73048CC	\$465
:	:	:	:

Curved Corner Worksurfaces

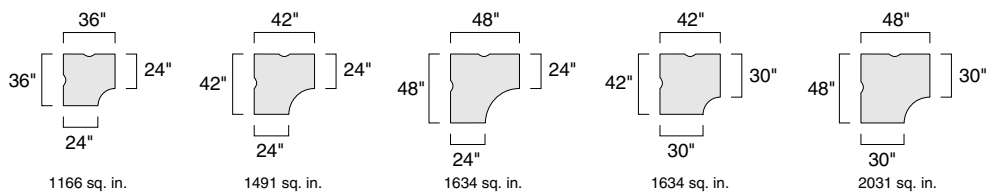

Straight Corner and Curved Corner Worksurfaces with Adjustable Keyboard Shelf

Straight Corner and Curved Corner Worksurfaces with Adjustable Keyboard Shelf

Panel Supported

SIN 711.1

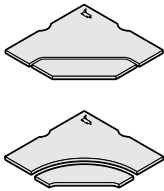

Tip: Keyboard surface adjusts 6" higher or 5" lower than worksurface height.

Tip: Curved corner worksurfaces with adjustable keyboard shelf must be panel hung.

Tip: 24"D curved corner worksurface with adjustable keyboard shelf must be supported with a center support on each side.

Tip: 30"D curved corner worksurface with adjustable keyboard shelf can be supported with a cantilever or center support.

Standard Includes	Required to Specify
<ul style="list-style-type: none"> • Monitor and keyboard worksurface: laminate • 3 mm radius profile edge on user's side: vinyl default • Side and back edges: vinyl default • Cable scallops in the back edges • Corner bracket: black paint only 	<ol style="list-style-type: none"> 1 Style number 2 Laminate color number for monitor and keyboard worksurface 3 Options, if selected (see below) <p>▶ See <i>Surface Materials</i>, page B180.</p>

Options	Price	Required to Specify
Surface Materials <ul style="list-style-type: none"> • Wood veneer worksurface with wood edge • Customiz stain on wood 	+\$225 +\$ 41	Specify with <i>wood worksurface</i> and select wood color number. Specify with <i>Customiz stain</i> . ▶ See <i>Surface Materials Reference Manual</i> . Specify with <i>full-fill finish</i> and select wood color number. ▶ See <i>Surface Materials</i> , page B180. ▶ See <i>Surface Materials Reference Manual</i> . ▶ See <i>Surface Materials Reference Manual</i> .
<ul style="list-style-type: none"> • Full-fill finish 	+\$ 41	
<ul style="list-style-type: none"> • Accent laminate 	+\$ 60	
<ul style="list-style-type: none"> • Open Line laminate 	+\$ 60 plus cost of laminate	

Related Products <ul style="list-style-type: none"> • Worksurface legs and supports • Worksurface wire manager 	▶ Page B124 ▶ Page B128
---	----------------------------

Specification Information

Depth	Width	Style Number	Base Price
⋮	⋮	⋮	⋮

Straight Corner

24"	42"	TS72442SCP	\$695
24"	48"	TS72448SCP	\$742
30"	48"	TS73048SCP	\$791
⋮	⋮	⋮	⋮

Curved Corner

24"	42"	TS72442CCP	\$768
24"	48"	TS72448CCP	\$813
30"	48"	TS73048CCP	\$852
⋮	⋮	⋮	⋮

Extended Curved Corner Worksurfaces

Left-Hand Units

SIN 711.1

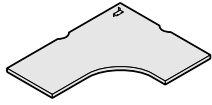

Standard Includes	Required to Specify
-------------------	---------------------

- Worksurface: laminate
- 3 mm radius profile edge on user's side: vinyl default
- Side and back edges: vinyl default
- Cable scallops in the back edges
- Corner bracket: black paint only

- 1 Style number
 - 2 Laminate color number for worksurface
 - 3 Options, if selected (see below)
- ▶ See *Surface Materials*, page B180.

Options	Price	Required to Specify
---------	-------	---------------------

Surface Materials

- Accent laminate +\$60
- Open Line laminate +\$60 plus cost of laminate

- ▶ See *Surface Materials Reference Manual*.
▶ See *Surface Materials Reference Manual*.

Related Products

- Worksurface legs and supports
- Modesty panels
- Worksurface wire manager

- ▶ Page B124
▶ Page B127
▶ Page B128

For additional dimensions, ▶ See page B100

Extended Curved Corner Worksurfaces

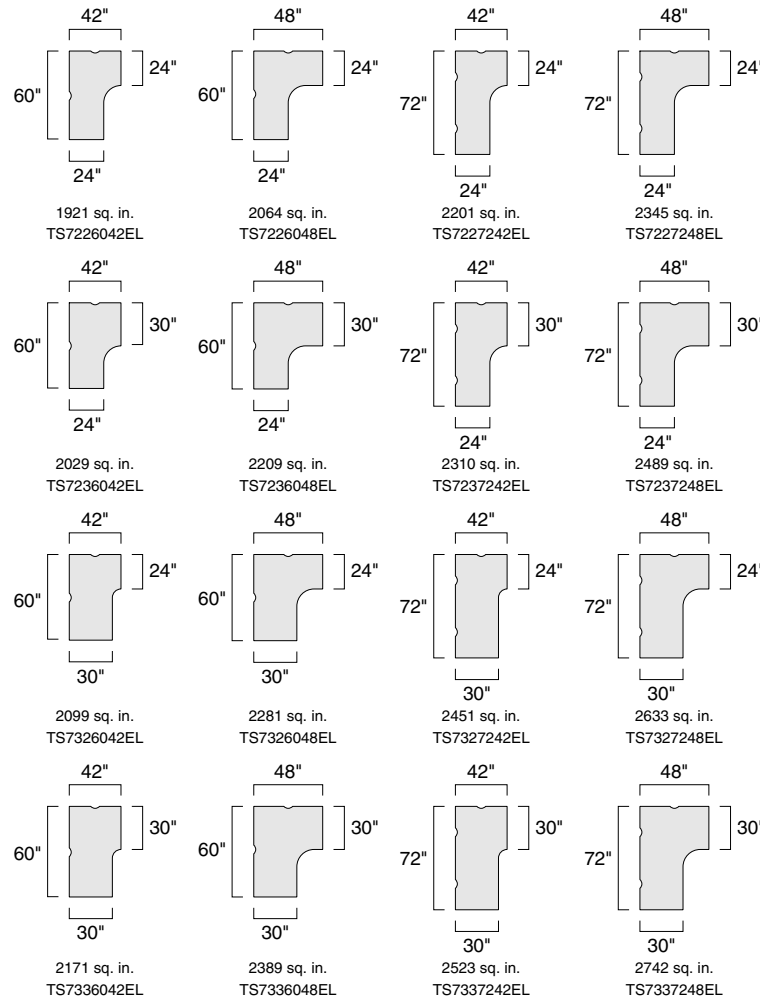

Answer

Specification Information

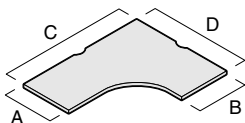

Dimensions				Style Number	Base Price
A	B	C	D		
24"	24"	60"	42"	TS7226042EL	\$602
24"	24"	60"	48"	TS7226048EL	\$613
24"	24"	72"	42"	TS7227242EL	\$711
24"	24"	72"	48"	TS7227248EL	\$724
24"	30"	60"	42"	TS7236042EL	\$661
24"	30"	60"	48"	TS7236048EL	\$675
24"	30"	72"	42"	TS7237242EL	\$774
24"	30"	72"	48"	TS7237248EL	\$785
30"	24"	60"	42"	TS7326042EL	\$661
30"	24"	60"	48"	TS7326048EL	\$675
30"	24"	72"	42"	TS7327242EL	\$774
30"	24"	72"	48"	TS7327248EL	\$785
30"	30"	60"	42"	TS7336042EL	\$693
30"	30"	60"	48"	TS7336048EL	\$706
30"	30"	72"	42"	TS7337242EL	\$804
30"	30"	72"	48"	TS7337248EL	\$815

Extended Curved Corner Worksurfaces

Right-Hand Units

SIN 711.1

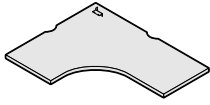

Standard Includes	Required to Specify
-------------------	---------------------

- Worksurface: laminate
- 3 mm radius profile edge on user's side: vinyl default
- Side and back edges: vinyl default
- Cable scallops in the back edges
- Corner bracket: black paint only

- 1 Style number
 - 2 Laminate color number for worksurface
 - 3 Options, if selected (see below)
- ▶ See *Surface Materials*, page B180.

Options	Price	Required to Specify
---------	-------	---------------------

Surface Materials

- Accent laminate +\$60
- Open Line laminate +\$60 plus cost of laminate

- ▶ See *Surface Materials Reference Manual*.
▶ See *Surface Materials Reference Manual*.

Related Products

- Worksurface legs and supports
- Modesty panels
- Worksurface wire manager

- ▶ Page B124
▶ Page B127
▶ Page B128

For additional dimensions,
▶ See page B98

Extended Curved Corner Worksurfaces

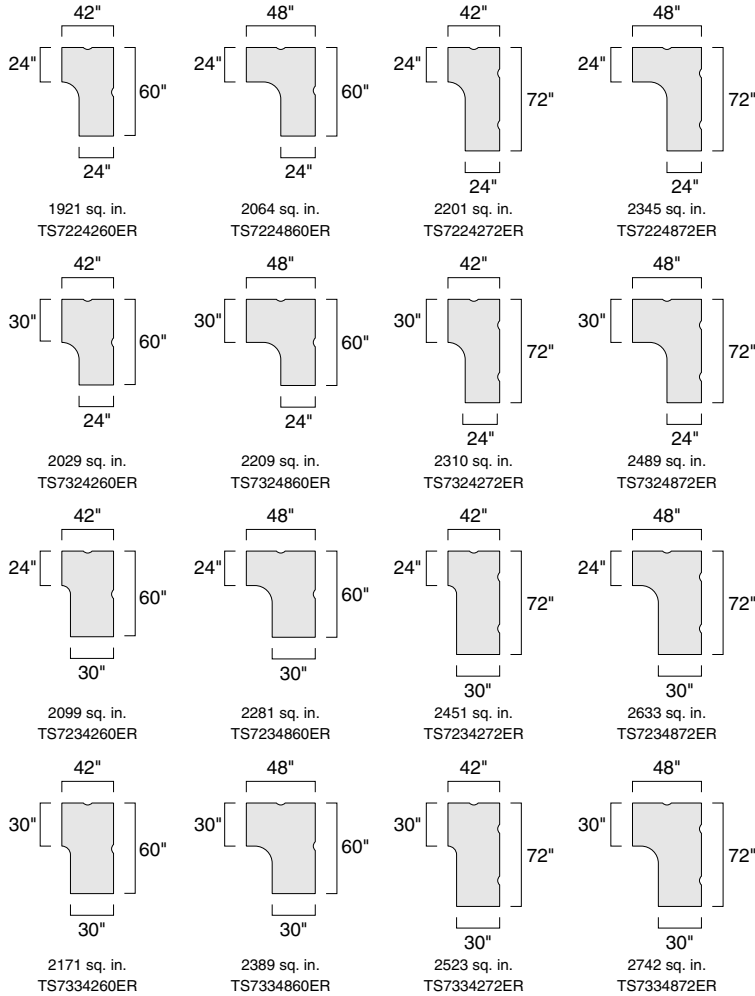

Answer

Specification Information

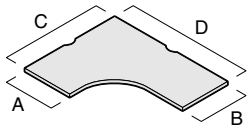

Dimensions				Style Number	Base Price
A	B	C	D		
24"	24"	42"	60"	TS7224260ER	\$602
24"	24"	42"	72"	TS7224272ER	\$711
24"	24"	48"	60"	TS7224860ER	\$613
24"	24"	48"	72"	TS7224872ER	\$724
24"	30"	42"	60"	TS7234260ER	\$661
24"	30"	42"	72"	TS7234272ER	\$774
24"	30"	48"	60"	TS7234860ER	\$675
24"	30"	48"	72"	TS7234872ER	\$785
30"	24"	42"	60"	TS7324260ER	\$661
30"	24"	42"	72"	TS7324272ER	\$774
30"	24"	48"	60"	TS7324860ER	\$675
30"	24"	48"	72"	TS7324872ER	\$785
30"	30"	42"	60"	TS7334260ER	\$693
30"	30"	42"	72"	TS7334272ER	\$804
30"	30"	48"	60"	TS7334860ER	\$706
30"	30"	48"	72"	TS7334872ER	\$815

Bridge Worksurfaces

SIN 711.1

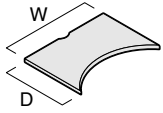

Tip: Bridge worksurfaces can be freestanding if C-legs are used.

Standard Includes	Required to Specify
-------------------	---------------------

- Worksurface: laminate
- 3 mm radius profile edge on user's side: vinyl default
- Side and back edges: vinyl default
- Cable scallops

- 1 Style number
 - 2 Laminate color number for worksurface
 - 3 Options, if selected (see below)
- ▶ See *Surface Materials*, page B180.

Surface Materials	Options	Price	Required to Specify
-------------------	---------	-------	---------------------

Surface Materials	• Wood veneer worksurface with wood edge	+ \$235	Specify with <i>wood worksurface</i> and select wood color number. Specify with <i>Customiz stain</i> . ▶ See <i>Surface Materials Reference Manual</i> .
	• Customiz stain on wood	+ \$ 41	
	• Full-fill finish	+ \$ 41	Specify with <i>full-fill finish</i> and select wood color number. ▶ See <i>Surface Materials</i> , page B180.
	• Accent laminate	+ \$ 60	▶ See <i>Surface Materials Reference Manual</i> .
	• Open Line laminate	+ \$ 60 plus cost of laminate	▶ See <i>Surface Materials Reference Manual</i> .

Related Products

- Worksurface legs and supports
- Cantilever
- Side-support bracket
- Worksurface wire manager

- ▶ Page B124
- ▶ Page B125
- ▶ Page B125
- ▶ Page B128

Specification Information

• Depth	• Width	• Style Number	• Base Price
30"	42"	TS73042BR	\$370
30"	48"	TS73048BR	\$432

Bridge Worksurfaces

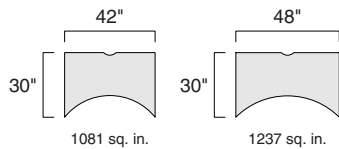

Scoop Worksurface

SIN 711.1

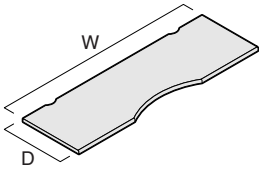

Tip: Cantilever, ordered separately, is required to support center of scoop worksurface.

▶ Page B125

Tip: Reinforcing channel (TS772RC) is available to add support to worksurfaces that have 72" or more of unsupported kneespace and which will be heavily loaded; must be ordered separately.

▶ Page B125

Standard Includes	Required to Specify
<ul style="list-style-type: none"> • Worksurface: laminate • 3 mm radius profile edge on user's side: vinyl default • Side and back edges: vinyl default • Cable scallops 	<ol style="list-style-type: none"> 1 Style number 2 Laminate color number for worksurface 3 Options, if selected (see below) <p>▶ See <i>Surface Materials</i>, page B180.</p>

Options	Price	Required to Specify
Surface Materials <ul style="list-style-type: none"> • Wood veneer worksurface with wood edge • Customiz stain on wood 	<ul style="list-style-type: none"> +\$450 +\$ 84 	Specify with wood worksurface and select wood color number. Specify with Customiz stain. ▶ See <i>Surface Materials Reference Manual</i> .
<ul style="list-style-type: none"> • Full-fill finish 	<ul style="list-style-type: none"> +\$ 84 	Specify with full-fill finish and select wood color number. ▶ See <i>Surface Materials</i> , page B180.
<ul style="list-style-type: none"> • Accent laminate 	<ul style="list-style-type: none"> +\$ 60 	▶ See <i>Surface Materials Reference Manual</i> .
<ul style="list-style-type: none"> • Open Line laminate 	<ul style="list-style-type: none"> +\$ 60 plus cost of laminate 	▶ See <i>Surface Materials Reference Manual</i> .

Related Products		
<ul style="list-style-type: none"> • Worksurface legs and supports • End panel • Modesty panel • Worksurface wire manager 	<ul style="list-style-type: none"> ▶ Page B124 ▶ Page B126 ▶ Page B127 ▶ Page B128 	

Specification Information			
Depth	Width	Style Number	Base Price
30"	96"	TS73096SP	\$723

Scoop Worksurface

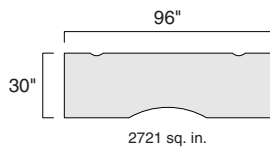

Wave Worksurfaces

SIN 711.1

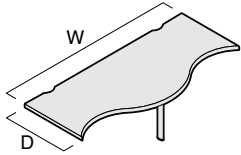

Tip: Remember to order side supports separately.

▶ Page B125

Standard Includes		Required to Specify	
<ul style="list-style-type: none"> • Worksurface: laminate • 3 mm radius profile edge on user's side: vinyl default • Single post leg: paint • Corner bracket: black paint • Side and back edges: vinyl default • Cable scallops 		<ol style="list-style-type: none"> 1 Style number 2 Laminate color number for worksurface 3 Paint color number for single post leg 4 Options, if selected (see below) <p>▶ See <i>Surface Materials</i>, page B180.</p>	
Surface Materials	Options	Price	Required to Specify
	• Wood veneer worksurface with wood edge	+\$475	Specify with <i>wood worksurface</i> and select wood color number.
	• Customiz stain on wood	+\$ 84	Specify with <i>Customiz stain</i> . ▶ See <i>Surface Materials Reference Manual</i> .
	• Full-fill finish	+\$ 84	Specify with <i>full-fill finish</i> and select wood color number. ▶ See <i>Surface Materials</i> , page B180.
	• Accent laminate	+\$ 60	▶ See <i>Surface Materials Reference Manual</i> .
	• Open Line laminate	+\$ 60 plus cost of laminate	▶ See <i>Surface Materials Reference Manual</i> .
Supports	• Standing-height single post leg	+\$ 11	Specify with <i>standing-height single post leg</i> .
	• Double post leg	+\$102	Specify with <i>double post leg</i> .
	• Standing-height double post leg	+\$131	Specify with <i>standing-height double post leg</i> .
Related Products	• Worksurface legs and supports		▶ Page B124
	• Worksurface wire manager		▶ Page B128

Specification Information			
Depth	Width	Style Number	Base Price
36"	84"	TS73684WV	\$918
36"	96"	TS73696WV	\$986
:	:	:	:

Wave Worksurfaces

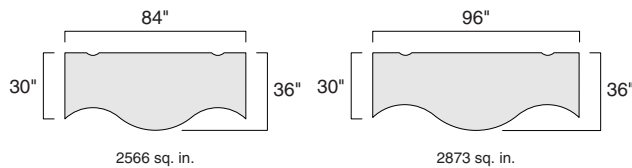

SIN 711.1

Peninsula and Bullet Peninsula Worksurfaces

SIN 711.1

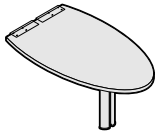

Standard Includes	Required to Specify
<ul style="list-style-type: none"> • Worksurface: laminate • 3 mm radius profile edge on user's side: vinyl default • Double post leg: paint • Attachment hardware: black paint 	<ol style="list-style-type: none"> 1 Style number 2 Laminate color number for worksurface 3 Paint color number for double post leg 4 Options, if selected (see below) <p>▶ See <i>Surface Materials</i>, page B180.</p>

Surface Materials	Options	Price	Required to Specify
	<ul style="list-style-type: none"> • Accent laminate 	+\$ 60	▶ See <i>Surface Materials Reference Manual</i> .
	<ul style="list-style-type: none"> • Open Line laminate 	+\$ 60 plus cost of laminate	▶ See <i>Surface Materials Reference Manual</i> .
	Peninsula worksurface		
	<ul style="list-style-type: none"> • Wood veneer worksurface with wood edge 	+\$300	Specify <i>with wood worksurface</i> and select wood color number.
	<ul style="list-style-type: none"> • Customiz stain on wood 	+\$ 84	Specify <i>with Customiz stain</i> .
			▶ See <i>Surface Materials Reference Manual</i> .
	<ul style="list-style-type: none"> • Full-fill finish 	+\$ 84	Specify <i>with full-fill finish</i> and select wood color number.
			▶ See <i>Surface Materials</i> , page B180.
	Bullet peninsula worksurface		
	<ul style="list-style-type: none"> • Wood veneer worksurface with wood edge 	+\$300	Specify <i>with wood worksurface</i> and select wood color number.
<ul style="list-style-type: none"> • Customiz stain on wood 	+\$ 84	Specify <i>with Customiz stain</i> .	
		▶ See <i>Surface Materials Reference Manual</i> .	
<ul style="list-style-type: none"> • Full-fill finish 	+\$ 84	Specify <i>with full-fill finish</i> and select wood color number.	
		▶ See <i>Surface Materials</i> , page B180.	
Legs	<ul style="list-style-type: none"> • Standing-height double post legs 	+\$ 29	Specify <i>with standing-height double post legs</i> .
Related Products	<ul style="list-style-type: none"> • Cantilever • Side-support bracket 		▶ Page B125 ▶ Page B125

Specification Information

Depth	Width	Style Number	Base Price
-------	-------	--------------	------------

Peninsula Worksurfaces

30"	48"	TS73048P	\$629
30"	60"	TS73060P	\$655

Bullet Peninsula Worksurfaces

30"	60"	TS73060BP	\$655
30"	66"	TS73066BP	\$666
30"	72"	TS73072BP	\$676

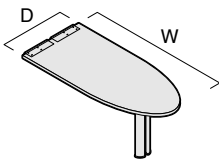
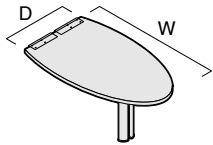

Peninsula Worksurfaces

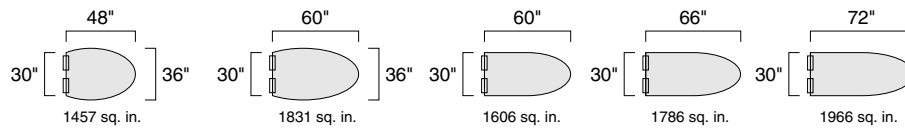

Angled Peninsula Worksurfaces

SIN 711.1

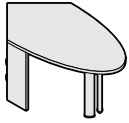

Standard Includes	Required to Specify
<ul style="list-style-type: none"> • Worksurface: laminate • 3 mm radius profile edge on user's side: vinyl default • Double post leg: paint • Conference end support for use on 24"D or 30"D left or right side of angled peninsula worksurface: paint • Attachment hardware: black paint 	<ol style="list-style-type: none"> 1 Style number 2 Laminate color number for worksurface 3 Paint color number for double post leg and conference end support, if selected 4 Options, if selected (see below) <p>▶ See <i>Surface Materials</i>, page B180.</p>

	Options	Price	Required to Specify
Surface Materials	• Wood veneer worksurface with wood edge	+\$300	Specify <i>with wood worksurface</i> and select wood color number.
	• Customiz stain on wood	+\$ 84	Specify <i>with Customiz stain</i> . ▶ See <i>Surface Materials Reference Manual</i> .
	• Full-fill finish	+\$ 84	Specify <i>with full-fill finish</i> and select wood color number. ▶ See <i>Surface Materials</i> , page B180.
	• Accent laminate	+\$ 60	▶ See <i>Surface Materials Reference Manual</i> .
	• Open Line laminate	+\$ 60 plus cost of laminate	▶ See <i>Surface Materials Reference Manual</i> .
Supports	• Standing-height double post legs and standing-height conference end supports for 24"D and 30"D	+\$ 39	Specify <i>with standing-height double post legs and standing-height conference end supports</i> .
Related Products	• Cantilever		▶ Page B125
	• Side-support bracket		▶ Page B125

Specification Information

Depth	Width	Style Number	Base Price
-------	-------	--------------	------------

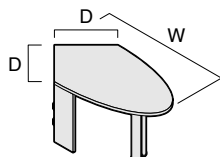

With Double Post Leg and Conference End Support

24"	48"	TS72448AP	\$655
24"	60"	TS72460AP	\$683
30"	48"	TS73048AP	\$670
30"	60"	TS73060AP	\$696

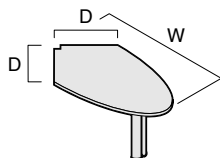

With Double Post Leg Only

27"	48"	TS72748AP	\$690
27"	60"	TS72760AP	\$717
33"	48"	TS73348AP	\$702
33"	60"	TS73360AP	\$730

Angled Peninsula Worksurfaces with Double Post Leg Only

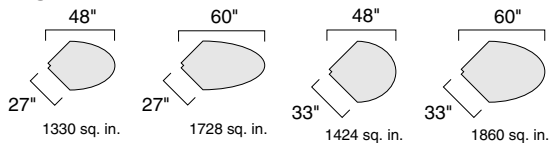

Angled Peninsula Worksurfaces with Double Post Leg and Conference Support

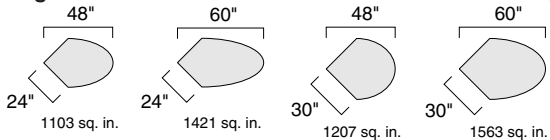

Spanner Worksurfaces

SIN 711.1

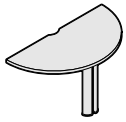

Tip: Remember to specify cantilevers to attach spanner work surface to adjacent work surfaces on 51" and 63" spanner tops.

Standard Includes		Required to Specify
<ul style="list-style-type: none"> • Worksurface: laminate • 3 mm radius profile edge on user's side: vinyl default • Double-post leg: paint 		<ol style="list-style-type: none"> 1 Style number 2 Laminate color number for worksurface 3 Paint color number for leg 4 Options, if selected (see below) <p>▶ See <i>Surface Materials</i>, page B180.</p>

Options	Price	Required to Specify
Surface Materials		
<ul style="list-style-type: none"> • Wood veneer worksurface with wood edge • Customiz stain on wood 	<p>+\$300</p> <p>+\$ 60</p>	<p>Specify <i>with wood worksurface</i> and select wood color number.</p> <p>Specify <i>with Customiz stain</i>.</p> <p>▶ See <i>Surface Materials Reference Manual</i>.</p>
<ul style="list-style-type: none"> • Full-fill finish 	+\$ 60	<p>Specify <i>with full-fill finish</i> and select wood color number.</p>
<ul style="list-style-type: none"> • Accent laminate 	+\$ 60	▶ See <i>Surface Materials</i> , page B180.
<ul style="list-style-type: none"> • Open Line laminate 	+\$ 60 plus cost of laminate	▶ See <i>Surface Materials Reference Manual</i> .
Legs		
<ul style="list-style-type: none"> • Standing-height double post leg 	+\$ 29	Specify <i>with standing-height double post leg</i> .
<ul style="list-style-type: none"> • Substitute leg package with two post legs and two post legs with casters to make freestanding spanner table in the field on 51"W and 63"W 	+\$108	Specify <i>with post legs</i> .
Related Products	<ul style="list-style-type: none"> • Worksurface legs and supports 	▶ Page B124

Specification Information

Depth	Width	Style Number	Base Price

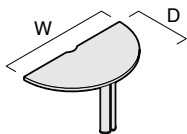

Spanner Worksurfaces with One Double Post Leg

25½"	51"	TS751HR	\$518
31½"	63"	TS763HR	\$614

Spanner Worksurfaces with One Double Post Leg

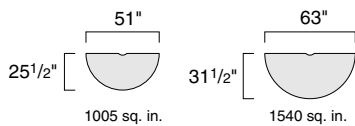

Trapezoid and Spanner Tables

SIN 711.1

Answer

Standard Includes	Required to Specify
<ul style="list-style-type: none"> • Worksurface: laminate • 3 mm radius profile edge on user's side: vinyl default • Two post legs and two post legs with casters: paint 	<ol style="list-style-type: none"> 1 Style number 2 Laminate color number for worksurface 3 Paint color number for legs 4 Options, if selected (see below) <p>▶ See <i>Surface Materials</i>, page B180.</p>

Options	Price	Required to Specify
Surface Materials		
• Wood veneer worksurface with wood edge on spanner worksurface only	+\$300	Specify with <i>wood worksurface</i> and select wood color number.
• Customiz stain on wood	+\$ 60	Specify with <i>Customiz stain</i> . ▶ See <i>Surface Materials Reference Manual</i> .
• Full-fill finish	+\$ 60	Specify with <i>full-fill finish</i> and select wood color number. ▶ See <i>Surface Materials</i> , page B180.
• Accent laminate	+\$ 60	▶ See <i>Surface Materials Reference Manual</i> .
• Open Line laminate	+\$ 60 plus cost of laminate	▶ See <i>Surface Materials Reference Manual</i> .

Specification Information

Depth	Width	Style Number	Base Price
-------	-------	--------------	------------

Trapezoid Table

24"	72"	TS772TR	\$718
-----	-----	----------------	-------

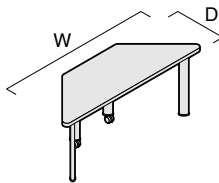

Spanner Worksurfaces with Two Post Legs and Two Post Legs with Casters

24"	48"	TS748HR	\$518
30"	60"	TS760HR	\$614

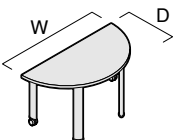

Trapezoid Table

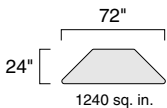

Spanner Worksurfaces with Four Post Legs

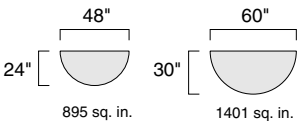

Oval Worksurfaces

SIN 711.1

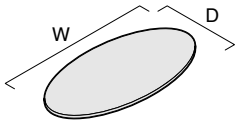

Standard Includes	Required to Specify
<ul style="list-style-type: none"> • Worksurface: laminate • Slight radius profile edge on user's side: vinyl default 	<ol style="list-style-type: none"> 1 Style number 2 Laminate color number for worksurface 3 Options, if selected (see below) <p>▶ See <i>Surface Materials</i>, page B180.</p>

Surface Materials	Options	Price	Required to Specify
	<ul style="list-style-type: none"> • Wood veneer worksurface with wood edge <ul style="list-style-type: none"> —42"W +\$250 —60"W to 72"W +\$300 • Customiz stain on wood Prices at right 		Specify <i>with wood worksurface</i> and select wood color number.
	<ul style="list-style-type: none"> • Full-fill finish Prices at right 		Specify <i>with Customiz stain</i> . ▶ See <i>Surface Materials Reference Manual</i> . Specify <i>with full-fill finish</i> and select wood color number.
	<ul style="list-style-type: none"> • Accent laminate +\$ 60 • Open Line laminate +\$ 60 plus cost of laminate 		▶ See <i>Surface Materials</i> , page B180. ▶ See <i>Surface Materials Reference Manual</i> . ▶ See <i>Surface Materials Reference Manual</i> .

Legs	Options	Price	Required to Specify
	Legs on 42"W oval worksurface		
	<ul style="list-style-type: none"> • Two post legs and two post legs with casters +\$272 • Four single post legs with casters +\$296 • Four single post legs +\$248 • Four nesting post legs with casters +\$272 		Specify <i>with two post legs and two post legs with casters</i> and indicate paint color number for legs. Specify <i>with four single post legs with casters</i> and indicate paint color number for legs. Specify <i>with four single post legs</i> and indicate paint color number for legs. Specify <i>with four nesting post legs with casters</i> and indicate paint color number for legs.
	Legs on 60"W and 72"W oval worksurfaces		
	<ul style="list-style-type: none"> • Two post legs and two post legs with casters +\$272 • Four single post legs +\$248 		Specify <i>with two post legs and two post legs with casters</i> and indicate paint color number for legs. Specify <i>with four single post legs</i> and indicate paint color number for legs.

SIN 711.1

Specification Information

• Dimensions		• Style Number	• Base Price	• Options (Add \$ to Base Price)
D	W			
21"	42"	TS72142WT	\$401	+\$41
30"	60"	TS73060WT	\$738	+\$60
36"	72"	TS73672WT	\$815	+\$84
:	:	:	:	:

Oval Worksurfaces

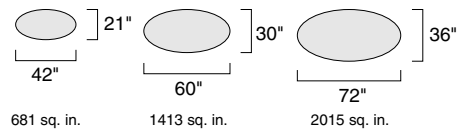

Answer

Visitor and Curved Linking Worksurfaces

SIN 711.1

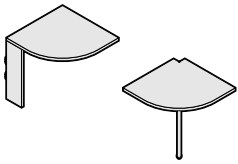

Standard Includes	Required to Specify
<ul style="list-style-type: none"> • Worksurface: laminate • 3 mm radius profile edge on user's side: vinyl default • Single post leg on curved linking worksurface: paint • Center support panel for use on left or right side of visitor worksurface: paint 	<ol style="list-style-type: none"> 1 Style number 2 Laminate color number for worksurface 3 Paint color number for leg or center support panel 4 Options, if selected (see below) <p>▶ See <i>Surface Materials</i>, page B180.</p>

	Options	Price	Required to Specify
Surface Materials	• Wood veneer worksurface with wood edge	+\$235	Specify <i>with wood worksurface</i> and select wood color number.
	• Customiz stain on wood	+\$ 24	Specify <i>with Customiz stain</i> . ▶ See <i>Surface Materials Reference Manual</i> .
	• Full-fill finish	+\$ 24	Specify <i>with full-fill finish</i> and select wood color number. ▶ See <i>Surface Materials</i> , page B180.
	• Accent laminate	+\$ 60	▶ See <i>Surface Materials Reference Manual</i> .
	• Open Line laminate	+\$ 60 plus cost of laminate	▶ See <i>Surface Materials Reference Manual</i> .

	Options	Price	Required to Specify
Supports	Visitor worksurfaces		
	• Standing-height center support panel	+\$ 10	Specify <i>with standing-height center support panel</i> .
	Curved linking worksurfaces		
	• Standing-height single post leg	+\$ 11	Specify <i>with standing-height single post leg</i> .

Specification Information

Depth Left	Depth Right	Style Number	Base Price
---------------	----------------	-----------------	---------------

Visitor Worksurfaces

24"	24"	TS72424V	\$409
24"	30"	TS72430V	\$421
30"	24"	TS73024V	\$421
30"	30"	TS73030V	\$421

Curved Linking Worksurfaces

27"	27"	TS72727L	\$504
27"	33"	TS72733L	\$517
33"	27"	TS73327L	\$517
33"	33"	TS73333L	\$517

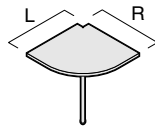
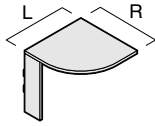

Tip: Remember to order cantilevers to connect curved linking worksurfaces to adjacent worksurfaces.

▶ Page B125

Visitor Worksurfaces

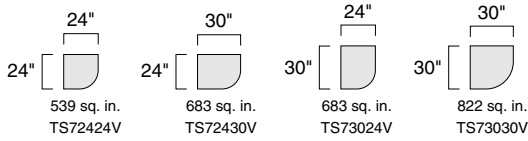

Curved Linking Worksurfaces

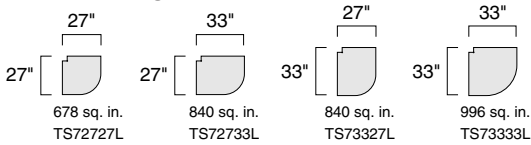

Transaction Countertops

Panel Supported

SIN 711.1

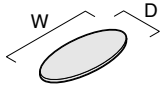

Standard Includes	Required to Specify
<ul style="list-style-type: none"> Countertop: laminate Slight radius profile edge: vinyl default Top caps: paint Support brackets: black paint only 	<ol style="list-style-type: none"> Style number Laminate color number for countertop Paint color number for top caps Options, if selected (see below) <p>▶ See <i>Surface Materials</i>, page B180.</p>

Options	Price	Required to Specify
Surface Materials <ul style="list-style-type: none"> Wood veneer worksurface with wood edge Customiz stain on wood 	+\$250 Prices below	Specify <i>with wood worksurface</i> and select wood color number. Specify <i>with Customiz stain</i> . ▶ See <i>Surface Materials Reference Manual</i> .
<ul style="list-style-type: none"> Full-fill finish 	Prices below	Specify <i>with full-fill finish</i> and select wood color number. ▶ See <i>Surface Materials</i> , page B180. ▶ See <i>Surface Materials Reference Manual</i> .
<ul style="list-style-type: none"> Accent laminate 	+\$ 60	▶ See <i>Surface Materials Reference Manual</i> .
<ul style="list-style-type: none"> Open Line laminate 	+\$ 60 plus cost of laminate	▶ See <i>Surface Materials Reference Manual</i> .
Top cap		
<ul style="list-style-type: none"> Wood 	+\$ 88	Specify <i>with wood top cap</i> and select wood color number.
<ul style="list-style-type: none"> Customiz stain on wood 	No cost	Specify <i>with Customiz stain</i> .

Tip: Top cap not available in full-fill finish.

Specification Information				
Depth	Width	Style Number	Base Price	Options (Add \$ to Base Price)
16"	32¾"	TS71636TC	\$292	+\$41
16"	38¾"	TS71642TC	\$314	+\$41
16"	44¾"	TS71648TC	\$335	+\$41
16"	56¾"	TS71660TC	\$362	+\$60
.

Adjustable-Height Worksurfaces

with Crank

SIN 711.1

Adjustable-Height
Worksurfaces with Crank

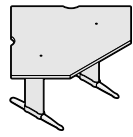

Tip: Gas cylinder package can be field installed to single and dual crank adjustable worksurfaces to provide additional lift.

Tip: Adjustable-height mechanism requires assembly. Also, work surface requires assembly to mechanism.

Tip: Extension link work surfaces may be attached only to corner or bi-level worksurfaces. They cannot be attached to dual worksurfaces.

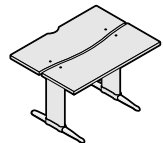
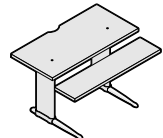
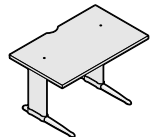
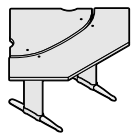
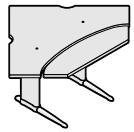
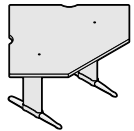

Standard Includes	Required to Specify
<ul style="list-style-type: none"> • Worksurface: laminate • Radius-edge profile on user's side: vinyl (PVC) default • Side and back edges: vinyl (PVC) default • Adjustable-height mechanism • Leg shrouds and feet: paint price group 1 • Crank handle 	<ol style="list-style-type: none"> 1 Style number 2 Laminate color number for work surface 3 Paint color number for leg shrouds and feet 4 Options, if selected (see below) <p>▶ See <i>Surface Materials</i>, page B180.</p>

Options	Price	Required to Specify
Surface Materials <ul style="list-style-type: none"> • Paint price group 1 • Paint price group 2 • Paint price group 3 • Accent laminate • Open Line laminate 	No cost +\$34 +\$58 +\$60 +\$60 plus cost of laminate	Specify paint color number. Specify paint color number. Specify paint color number. ▶ See <i>Surface Materials Reference Manual</i> . ▶ See <i>Surface Materials Reference Manual</i> .

Specification Information

Dimensions	Style Number	Base Price
D	W	Price

Corner Worksurfaces		
22 1/4"	39 1/4"	TS7CKSC42 \$1583
22 1/4"	45 1/4"	TS7CKSC48 \$1628

Dual Corner Worksurfaces		
22 1/4"	39 1/4"	TS7CKDC42 \$2183
22 1/4"	45 1/4"	TS7CKDC48 \$2228

Bi-Level Corner Worksurfaces		
22 1/4"	39 1/4"	TS7CKBC42 \$2183
22 1/4"	45 1/4"	TS7CKBC48 \$2228

Straight Worksurfaces		
28 1/4"	40"	TS7CKSS42 \$1493
28 1/4"	46"	TS7CKSS48 \$1542

Dual Straight Worksurfaces		
34 1/4"	40"	TS7CKDS42 \$2093
34 1/4"	46"	TS7CKDS48 \$2142

Bi-Level Straight Worksurfaces		
34 1/4"	40"	TS7CKBS42 \$2093
34 1/4"	46"	TS7CKBS48 \$2142

Pair of Gas Cylinders	
TS7GC	\$ 150

Answer

Adjustable-Height Extension Link Worksurfaces

with Crank

SIN 711.1

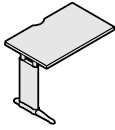

Tip: Extension link work-surfaces may be attached only to corner or bi-level worksurfaces. They cannot be attached to dual worksurfaces.

Tip: Adjustable-height mechanism requires attachment to the base and work-surface.

Standard Includes	Required to Specify
-------------------	---------------------

- Worksurface: laminate
- Radius edge profile on user's side: vinyl (PVC) default
- Side and back edges: vinyl (PVC) default
- Adjustable-height mechanism
- Leg shroud and foot: paint price group 1
- Gas cylinder

- 1 Style number
 - 2 Laminate color number for worksurface
 - 3 Paint color number for leg shroud and foot
 - 4 Options, if selected (see below)
- ▶ See *Surface Materials*, page B180.

Surface Materials	Options	Price	Required to Specify
-------------------	---------	-------	---------------------

Surface Materials

- Paint price group 1
- Paint price group 2
- Paint price group 3
- Accent laminate

No cost
+\$17
+\$29
+\$60

- Open line laminate

+\$60
plus cost of laminate

Specify paint color number.
Specify paint color number.
Specify paint color number.
▶ See *Surface Materials Reference Manual*.
▶ See *Surface Materials Reference Manual*.

Specification Information			
• Dimensions		• Style	• Base
D	W	Number	Price

Left-Hand

22¼"	24"	TS7CKEL24	\$1230
22¼"	36"	TS7CKEL36	\$1341
:	:	:	:

Right-Hand

22¼"	24"	TS7CKER24	\$1230
22¼"	36"	TS7CKER36	\$1341
:	:	:	:

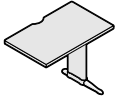
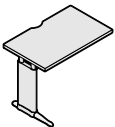

Adjustable-Height Worksurfaces

with Electrically Adjustable Column Support

SIN 711.1

Adjustable-Height
Worksurfaces with
Electrically Adjustable
Column Support

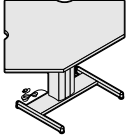

Tip: Adjustable-height mechanism requires attachment to the base and worksurface.

Standard Includes	Required to Specify
<ul style="list-style-type: none"> • Worksurface: laminate • Radius edge profile on user's side: vinyl (PVC) default • Side and back edges: vinyl (PVC) default • Drawer-mounted two-button controller • Attachment hardware • Adjustable-height column mechanism and base: paint price group 2 • 9' power cord: black vinyl only 	<ol style="list-style-type: none"> 1 Style number 2 Laminate color number for worksurface 3 Paint color number for column and base 4 Options, if selected (see below) <p>▶ See <i>Surface Materials</i>, page B180.</p>

Options	Price	Required to Specify
Surface Materials <ul style="list-style-type: none"> • Paint price group 1 • Paint price group 2 • Paint price group 3 • Customer's own laminate 	No cost +\$ 34 +\$ 58 +\$ 60	Specify paint color number. Specify paint color number. Specify paint color number. ▶ See <i>Transitional Specification Guide</i> . Specify with customer's own laminate. ▶ See <i>Surface Materials Reference Manual</i> .
Programmable Memory <ul style="list-style-type: none"> • Drawer-mounted six-button controller with 3x3 programmable memory and soft-start/soft-stop 	+\$299	Specify with SSM.
High-Performance Adjustable-Height Worksurface with Programmable Memory <ul style="list-style-type: none"> • 250 pound weight capacity and drawer-mounted six-button controller with 3x3 programmable memory and soft-start/soft-stop 	+\$699	Specify with 250SSM.

Specification Information

Planning Dimensions	Style Number	Base Price
D W		

Corner Worksurfaces		
24"	42"	TS7ECSC42 \$1943
24"	48"	TS7ECSC48 \$1988
:	:	:

Dual Corner Worksurfaces		
24"	42"	TS7ECDC42 \$2543
24"	48"	TS7ECDC48 \$2588
:	:	:

Straight Worksurfaces		
30"	42"	TS7ECSS42 \$1853
30"	48"	TS7ECSS48 \$1902
:	:	:

Dual Straight Worksurfaces		
36"	42"	TS7ECDS42 \$2453
36"	48"	TS7ECDS48 \$2502
:	:	:

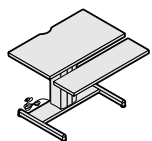
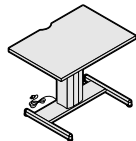
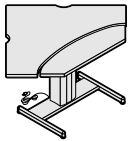
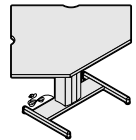

Angled Peninsula Worksurfaces for Use with Kick

SIN 711.1

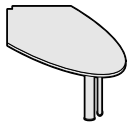

Standard Includes	Required to Specify
-------------------	---------------------

- Worksurface: laminate
- 3 mm radius profile edge on user's side: vinyl default
- Double post leg: paint
- Attachment hardware: black paint

- 1 Style number
 - 2 Laminate color number for worksurface
 - 3 Paint color number for double post leg
 - 4 Options, if selected (see below)
- ▶ See *Surface Materials*, page B180.

Options	Price	Required to Specify
---------	-------	---------------------

Surface Materials	• Wood veneer worksurface with wood edge	+\$300	Specify <i>with wood worksurface</i> and select wood color number.
	• Customiz stain on wood	+\$ 84	Specify <i>with Customiz stain</i> . ▶ See <i>Surface Materials Reference Manual</i> .
	• Full-fill finish	+\$ 84	Specify with full-fill finish and select wood color number. ▶ See <i>Surface Materials Reference Manual</i> .
	• Accent laminate	+\$ 60	▶ See <i>Surface Materials Reference Manual</i> .
	• Open Line laminate	+\$ 60 plus cost of laminate	▶ See <i>Surface Materials Reference Manual</i> .
Supports	• Standing-height double post leg	+\$ 29	Specify <i>with standing-height double post leg</i> .
Related Products	• Cantilever		▶ Page B125
	• Side-support bracket		▶ Page B125

Specification Information

• Depth	• Width	• Style Number	• Base Price
---------	---------	----------------	--------------

With Double Post Leg Only

26"	48"	TS72648APK	\$690
26"	60"	TS72660APK	\$717
32"	48"	TS73248APK	\$702
32"	60"	TS73260APK	\$730
•	•	•	•

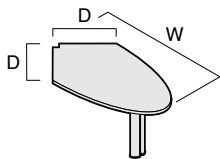

Angled Peninsula Worksurfaces with Double Post Leg Only

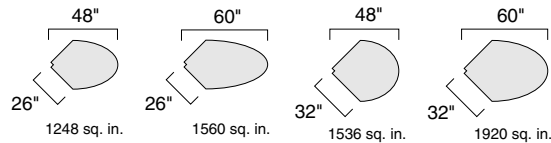

Spanner Worksurfaces for Use with Kick

SIN 711.1

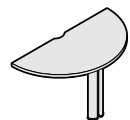

Tip: Remember to specify cantilevers to attach spanner work surface to adjacent worksurfaces.

Standard Includes		Required to Specify
<ul style="list-style-type: none"> • Worksurface: laminate • 3 mm radius profile edge on user's side: vinyl default • Double-post leg: paint 		<ol style="list-style-type: none"> 1 Style number 2 Laminate color number for worksurface 3 Paint color number for leg 4 Options, if selected (see below) <p>▶ See <i>Surface Materials</i>, page B180.</p>

Options	Price	Required to Specify
Surface Materials	<ul style="list-style-type: none"> • Wood veneer worksurface with wood edge +\$300 • Customiz stain on wood +\$ 60 • Full-fill finish +\$ 60 • Accent laminate +\$ 60 • Open Line laminate +\$ 60 plus cost of laminate 	Specify with <i>wood worksurface</i> and select wood color number. Specify with <i>Customiz stain</i> . ▶ See <i>Surface Materials Reference Manual</i> . Specify with full-fill finish and select wood color number. ▶ See <i>Surface Materials Reference Manual</i> . ▶ See <i>Surface Materials Reference Manual</i> . ▶ See <i>Surface Materials Reference Manual</i> .
Legs	<ul style="list-style-type: none"> • Standing-height double post leg +\$ 29 • Substitute leg package with two post legs and two post legs with casters to make freestanding spanner table in the field +\$108 	Specify with <i>standing-height double post leg</i> . Specify with <i>post leg</i> .
Related Products	<ul style="list-style-type: none"> • Worksurface legs and supports 	▶ Page B124

Specification Information

Depth	Width	Style Number	Base Price
-------	-------	--------------	------------

Spanner Worksurfaces with One Double Post Leg

25 1/2"	50"	TS750HRK	\$518
31 1/2"	62"	TS762HRK	\$614

Spanner Worksurfaces with One Double Post Leg

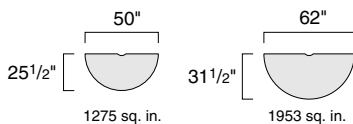

Answer

Curved Linking Worksurfaces for Use with Kick

SIN 711.1

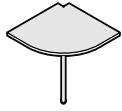

Standard Includes	Required to Specify
-------------------	---------------------

- Worksurface: laminate
- 3 mm radius profile edge on user's side: vinyl default
- Single post leg on curved linking worksurface: paint

- 1 Style number
 - 2 Laminate color number for worksurface
 - 3 Paint color number for leg
 - 4 Options, if selected (see below)
- ▶ See *Surface Materials*, page B180.

Surface Materials	Options	Price	Required to Specify
-------------------	---------	-------	---------------------

Surface Materials	• Wood veneer worksurface with wood edge	+\$235	Specify <i>with wood worksurface</i> and select wood color number. Specify <i>with Customiz stain</i> . ▶ See <i>Surface Materials Reference Manual</i> . Specify with full-fill finish and select wood color number. ▶ See <i>Surface Materials Reference Manual</i> . ▶ See <i>Surface Materials Reference Manual</i> . ▶ See <i>Surface Materials Reference Manual</i> .
	• Customiz stain on wood	+ \$ 24	
	• Full-fill finish	+ \$ 24	
	• Accent laminate	+ \$ 60	
	• Open Line laminate	+ \$ 60 plus cost of laminate	

Supports	• Standing-height single post leg	+ \$ 11	Specify <i>with standing-height single post leg</i> .
-----------------	-----------------------------------	---------	---

Specification Information			
Depth Left	Depth Right	Style Number	Base Price

26"	26"	TS72626LK	\$504
26"	32"	TS72632LK	\$517
32"	26"	TS73226LK	\$517
32"	32"	TS73232LK	\$517
:	:	:	:

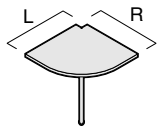

Tip: Remember to order cantilevers to connect curved linking worksurfaces to adjacent worksurfaces.
▶ Page B125

Curved Linking Worksurfaces

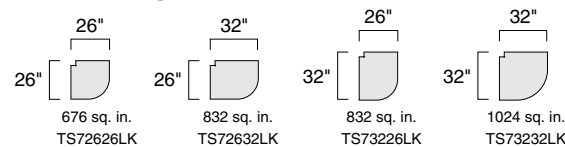

Curved Linking
Worksurfaces
for Use with Kick

SIN 711.1

Worksurface Legs and Supports

SIN 711.1

Standard Includes	Required to Specify
<ul style="list-style-type: none"> • Worksurface support: black paint <i>Exception: You can specify paint color choice for cantilever, legs, center support panel, and bracket to connect C-leg to modesty panel.</i> • Attachment hardware • Caster, if selected: black plastic only 	<ul style="list-style-type: none"> 1 Style number 2 Paint color number for cantilever legs, center support panel, and bracket to connect C-leg to modesty panel. <p>▶ See <i>Surface Materials</i>, page B180.</p>

Specification Information

• Dimensions	• Style Number	• Price

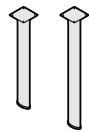

Single Post Legs

27"H	TS7SPL	\$ 62
------	---------------	-------

Standing Height

40"H	TS7SPLS	\$ 73
------	----------------	-------

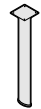

Nesting Post Leg

25"H	TS7NPL	\$ 57
------	---------------	-------

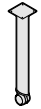

Single Post Leg with Caster

27"H	TS7SPLC	\$ 74
------	----------------	-------

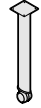

Nesting Post Leg with Caster

25"H	TS7NPLC	\$ 68
------	----------------	-------

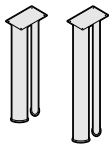

Double Post Legs

27"H	TS7DPL	\$164
------	---------------	-------

Standing Height

40"H	TS7DPLS	\$193
------	----------------	-------

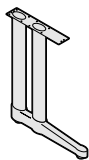

C-Leg

27"H	TS7CL	\$195
------	--------------	-------

Bracket to Connect Modesty Panel to C-Leg (package of 2)

	TS7CLB	\$ 29
--	---------------	-------

Specification Information

• Dimensions	• Style Number	• Price
--------------	----------------	---------



Cantilever with Tie Plate

16"D	13"H	TS7CANT	\$50
------	------	----------------	------

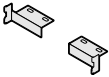

Side-Support Bracket to Connect Worksurface to Panel

N.A.	N.A.	TS70WPC	\$13
------	------	----------------	------

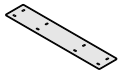

Support Plate

14"D		TS714WSP	\$32
20"D		TS720WSP	\$32



Package of Six Tie Plates for Side-by-Side Worksurfaces

3 ⁴⁵ / ₆₄ "L		TS7TIEPLATE	\$46
------------------------------------	--	--------------------	------

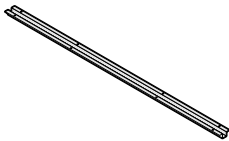

Reinforcing Channel

57"W		TS7WKSPT	\$24
72"W		TS772RC	\$56

Tip: Reinforcing channel is recommended to add support to worksurfaces that have 60" or more of unsupported knee-space.

Tip: Reinforcing channel can also be used in freestanding applications.

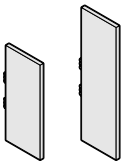

Center Support Panels

11"D	27 ¹ / ₂ "H	TS7CTRPNL	\$56
11"D	40"H	TS7CPS	\$66

End Panels

SIN 711.1

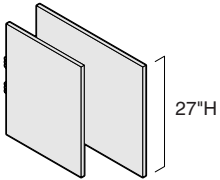

27"H

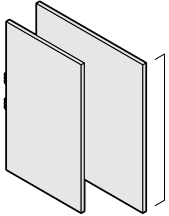

40"H

Tip: End panels cannot be used with wave or bridge worksurfaces.

Standard Includes	Required to Specify
<ul style="list-style-type: none"> End panel: paint price group 1 Attachment hardware 	<ul style="list-style-type: none"> 1 Style number 2 Paint color number for end panel 3 Options, if selected (see below) <p>▶ See <i>Surface Materials</i>, page B180.</p>

Options	Price	Required to Specify
Surface Materials		
• Paint price group 1	No cost	Specify paint color number.
• Paint price group 2	+\$25	Specify paint color number.
• Paint price group 3	+\$43	Specify paint color number.

Specification Information		
• Width	• Style Number	• Base Price
•	•	•
•	•	•
•	•	•

27"H End Panels

24"W	TS724EPNL	\$203
30"W	TS730EPNL	\$230
•	•	•

40"H Standing-Height End Panels

24"W	TS724EPS	\$239
30"W	TS730EPS	\$270
•	•	•

Worksurface Accessories

SIN 711.1

Modesty Panels

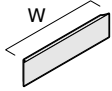

Tip: Use two modesty panels stacked to achieve a full-height modesty panel.

Tip: Order additional bracket when modesty panels are used with C-leg.

Standard Includes		Required to Specify	
-------------------	--	---------------------	--

- Ribbed-steel modesty panel: paint price group 1
- Attachment hardware

- 1 Style number
- 2 Paint color number for panel
- 3 Options, if selected (see below)
- ▶ See *Surface Materials*, page B180.

Surface Materials	Options	Price	Required to Specify
-------------------	---------	-------	---------------------

Surface Materials

- Paint price group 1
- Paint price group 2
- Paint price group 3

No cost
+\$25
+\$43

- Specify paint color number.
- Specify paint color number.
- Specify paint color number.

Specification Information

Width	Height	Style Number	Base Price
24"	11"	TS724MP	\$109
30"	11"	TS730MP	\$115
36"	11"	TS736MP	\$122
42"	11"	TS742MP	\$128
48"	11"	TS748MP	\$134
60"	11"	TS760MP	\$149
72"	11"	TS772MP	\$164
:	:	:	:

Pedestal-to-Modesty Panel Filler

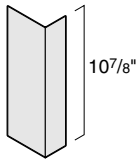

Tip: Filler must be attached to single-post leg and 20"D or 26"D pedestal.

Tip: If stacking two modesty panels, order two fillers.

Standard Includes		Required to Specify	
-------------------	--	---------------------	--

- Filler: paint

- 1 Style number
- 2 Paint color number for filler
- ▶ See *Surface Materials*, page B180.

Specification Information

Style Number	Price
TS7MPP	\$20
:	:

Worksurface Wiring and Cabling

SIN 711.1

Worksurface Wire Manager

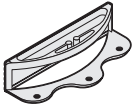

Standard Includes	Required to Specify
-------------------	---------------------

- Set of six field installed worksurface wire managers: plastic
- Attachment hardware

- 1 Style number
- 2 Plastic color number for worksurface wire manager:
 - 6000 Black
 - 6654 Sand (Vanadium)
 - 6695 Midnight
 - 6697 Fog

Specification Information	
---------------------------	--

• Style Number	• Price
TS7WWM	\$59

Cable Storage Tray

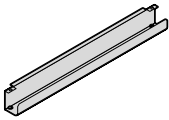

Standard Includes	Required to Specify
-------------------	---------------------

- Cable storage tray: black paint only

- Style number

Specification Information	
---------------------------	--

• Style Number	• Price
TS7CST	\$30

Leg Wire Manager



Standard Includes	Required to Specify
-------------------	---------------------

- Package of 20 wire managers: black plastic only

- Style number

Specification Information	
---------------------------	--

• Style Number	• Price
TS7LWM	\$30

Specifying Answer Storage

Storage

Universal Overhead Bins (SIN 711.1)	B130
Universal Overhead Bins with Wood Door (SIN 711.1)	B132
Universal Full-Height Shelves (SIN 711.1)	B133
Bracket Application Rules (SIN 711.1)	B134
Accessories (SIN 711.1)	B135
Wall Channels (SIN 711.1)	B136
Horizontal Braces (SIN 711.1)	B137
Dividers (SIN 711.1)	B138
Universal Curved Front Bins (SIN 711.1)	B139
Universal Curved Front Bins with Wood Doors (SIN 711.1)	B140
Universal L-Shelves (SIN 711.1)	B141
Universal Add-On Shelves (SIN 711.1)	B142
Bracket Application Rules (SIN 711.1)	B143
Accessories (SIN 711.1)	B144
Answer Overhead Bins (SIN 711.1)	B146
Answer Shelves (SIN 711.1)	B148
Answer Fixed Pedestals (SIN 711.1)	B150
Answer Mobile Pedestals (SIN 711.1)	B152
Answer Mobile Pedestal Cap Field-Installed Kit (SIN 711.1)	B154

Storage Accessories

Answer Filler for Use with Answer System Panels and Worksurfaces (SIN 711.1)	B156
Answer Filler for Use with Answer Underworksurface Lateral Files (SIN 711.1)	B156
Pedestal Attachment Cable (SIN 711.1)	B157
Pencil Trays (SIN 711.1)	B157
Pencil Tray for Use with 22"D Mobile Pedestals (SIN 711.1)	B157
Rail For Use with 24"D and 30"D Pedestals (SIN 711.1)	B158
Dividers for Use with 22"D Mobile Pedestals (SIN 711.1)	B158
Dividers for Use with Lateral Files (SIN 711.1)	B158
Adjustable Rails for Use with Lateral Files (SIN 711.1)	B159
Counterweight Packages (SIN 711.1)	B159
Hanging File Folder Frames (SIN 711.1)	B160
Flexible Markerboard Surfaces for Binder Bins (SIN 711.1)	B160
Brackets to Attach Avenir Bins and Shelves to Answer Panels (SIN 711.1)	B161
Dividers for Shelves and Overhead Storage Bins (SIN 711.1)	B161
Wall Channels for Shelves, Overhead Storage Bins, and Tackboards (SIN 711.1)	B162
Horizontal Braces (SIN 711.1)	B162
Markerboard (SIN 711.1)	B162
Tackboard (SIN 711.1)	B163
Hanging Kit for Markerboard or Tackboard (SIN 711.1)	B163

► For more detailed product information, see the *Answer Solutions Specification Guide* or consult your Steelcase dealer.

Answer products can be used with Pathways Technology Wall Panels.

Universal Overhead Bins

SIN 711.1

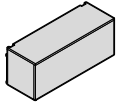

Standard Includes	Required to Specify
<ul style="list-style-type: none"> Overhead storage bin: paint price group 1 On-module brackets: black only Lock, keyed random: 9201 Polished Chrome 	1 Style number 2 Paint color number for storage bin. 3 Options, if selected (see below) ▶ See <i>Surface Materials</i> , page B180.

Options	Price	Required to Specify
Surface Materials Bin with one door <ul style="list-style-type: none"> Paint price group 1 Paint price group 2 Paint price group 3 Bin with two doors <ul style="list-style-type: none"> Paint price group 1 Paint price group 2 Paint price group 3 	No cost +\$ 38 +\$ 65 No cost +\$ 53 +\$ 90	Specify paint color number. Specify paint color number. Specify paint color number. Specify paint color number. Specify paint color number. Specify paint color number.
Lock and Keying Lock <ul style="list-style-type: none"> Ember Chrome Keying <ul style="list-style-type: none"> Factory- and field-installed keying 	No cost	Specify <i>with 9250 Ember Chrome lock</i> . ▶ Page B186
Related Products <ul style="list-style-type: none"> Wall channels Dividers Shelf lighting 		▶ Page B136 ▶ Page B138 ▶ Pages B172–B177

Specification Information				
Dimensions			Style	Base
D	W	H	Number	Price

For Use With Answer

Bin Without Lock

14¾"	24"	17⅛"	JBIN24TAK	\$330
14¾"	30"	17⅛"	JBIN30TAK	\$341
14¾"	36"	17⅛"	JBIN36TAK	\$368
14¾"	42"	17⅛"	JBIN42TAK	\$381
14¾"	48"	17⅛"	JBIN48TAK	\$393

With Two Doors

14¾"	60"	17⅛"	JBIN60TAK	\$591
14¾"	72"	17⅛"	JBIN72TAK	\$656

▶ **Specification Information, continued**

SIN 711.1

► Specification Information, continued

Specification Information

Dimensions			Style Number	Base Price
D	W	H		

For Use With Answer

Bin With Lock

14 ³ / ₄ "	24"	17 ¹ / ₈ "	JBIN24LTAK	\$380
14 ³ / ₄ "	30"	17 ¹ / ₈ "	JBIN30LTAK	\$391
14 ³ / ₄ "	36"	17 ¹ / ₈ "	JBIN36LTAK	\$418
14 ³ / ₄ "	42"	17 ¹ / ₈ "	JBIN42LTAK	\$431
14 ³ / ₄ "	48"	17 ¹ / ₈ "	JBIN48LTAK	\$443

With Two Doors

14 ³ / ₄ "	60"	17 ¹ / ₈ "	JBIN60LTAK	\$691
14 ³ / ₄ "	72"	17 ¹ / ₈ "	JBIN72LTAK	\$756

Universal Overhead Bins with Wood Door

SIN 711.1

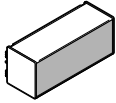

Tip: Only the door is wood. Cabinet is painted metal with standard finishes.

Tip: Veneer is natural flat cut.

Standard Includes		Required to Specify
<ul style="list-style-type: none"> Overhead storage bin: paint price group 1 One door for 24", 30", 36", 42", and 48" bins: wood Two doors for 60" and 72" bins: wood On-module brackets: black only Lock, keyed random: 9201 Polished Chrome 		<ul style="list-style-type: none"> 1 Style number 2 Paint color number for storage bin 3 Wood color number for door 4 Options, if selected (see below) ▶ See <i>Surface Materials</i>, page B180.
Options	Price	Required to Specify
Surface Materials	Bin with one wood door	
	<ul style="list-style-type: none"> Paint price group 1: No cost Paint price group 2: +\$38 Paint price group 3: +\$58 Customiz stain on wood veneer: +\$62 	<ul style="list-style-type: none"> Specify paint color number. Specify paint color number. Specify paint color number. Specify <i>with Customiz stain</i>. ▶ See <i>Surface Materials Reference Manual</i>.
	Bin with two wood doors	
	<ul style="list-style-type: none"> Paint price group 1: No cost Paint price group 2: +\$53 Paint price group 3: +\$80 Customiz stain on wood veneer: +\$62 	<ul style="list-style-type: none"> Specify paint color number. Specify paint color number. Specify paint color number. Specify <i>with Customiz stain</i>. ▶ See <i>Surface Materials Reference Manual</i>.
Lock and Keying	Lock	
	<ul style="list-style-type: none"> Ember Chrome: No cost 	Specify <i>with 9250 Ember Chrome lock</i> .
	Keying	
	<ul style="list-style-type: none"> Factory- and field-installed keying 	▶ Page B186
Related Products	<ul style="list-style-type: none"> Wall channels Dividers Shelf lighting 	<ul style="list-style-type: none"> ▶ Page B136 ▶ Page B138 ▶ Pages B172–B177

Specification Information

Dimensions			Style	Base
D	W	H	Number	Price

For Use With Answer

Bin With Lock

14 ³ / ₄ "	24"	17 ¹ / ₈ "	JBIN24LWTAK	\$ 630
14 ³ / ₄ "	30"	17 ¹ / ₈ "	JBIN30LWTAK	\$ 660
14 ³ / ₄ "	36"	17 ¹ / ₈ "	JBIN36LWTAK	\$ 690
14 ³ / ₄ "	42"	17 ¹ / ₈ "	JBIN42LWTAK	\$ 720
14 ³ / ₄ "	48"	17 ¹ / ₈ "	JBIN48LWTAK	\$ 750

With Two Doors

14 ³ / ₄ "	60"	17 ¹ / ₈ "	JBIN60LWTAK	\$1100
14 ³ / ₄ "	72"	17 ¹ / ₈ "	JBIN72LWTAK	\$1190

Universal Full-Height Shelves

SIN 711.1

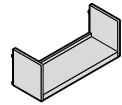

Standard Includes		Required to Specify	
<ul style="list-style-type: none"> Shelf: paint price group 1 On-module brackets: black only 		1 Style number 2 Paint color number for shelf 3 Options, if selected (see below) ▶ See <i>Surface Materials</i> , page B180.	
Options	Price	Required to Specify	
Surface Materials <ul style="list-style-type: none"> Paint price group 1 Paint price group 2 Paint price group 3 	No cost +\$13 +\$21	Specify paint color number. Specify paint color number. Specify paint color number. ▶ See <i>Surface Materials Reference Manual</i> .	
Related Products <ul style="list-style-type: none"> Wall channels Dividers Shelf lighting 		▶ Page B136 ▶ Page B138 ▶ Pages B172–B177	

Specification Information

Dimensions			Style	Base
D	W	H	Number	Price
:	:	:	:	:

For Use With Answer

15 ⁵ / ₈ "	24"	16 ¹ / ₂ "	JSHF24TAK	\$138
15 ⁵ / ₈ "	30"	16 ¹ / ₂ "	JSHF30TAK	\$148
15 ⁵ / ₈ "	36"	16 ¹ / ₂ "	JSHF36TAK	\$168
15 ⁵ / ₈ "	42"	16 ¹ / ₂ "	JSHF42TAK	\$171
15 ⁵ / ₈ "	48"	16 ¹ / ₂ "	JSHF48TAK	\$181
15 ⁵ / ₈ "	60"	16 ¹ / ₂ "	JSHF60TAK	\$202
15 ⁵ / ₈ "	72"	16 ¹ / ₂ "	JSHF72TAK	\$214
:	:	:	:	:

Answer

Bracket Application Rules

for Universal Overhead Bin and Universal Full-Height Shelf
SIN 711.1

Bracket Application Matrix

	On-module	Off-module
Answer	•	
Kick	•	
Montage	•	
Enhanced Off-Module Montage	•	•
Pathways Technology Wall	•	•

On-Module Brackets

On-module brackets are used to mount bins and shelves to panels with vertical slot patterns.

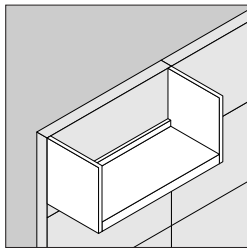
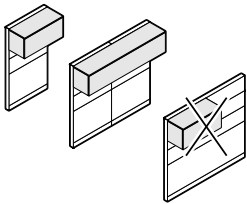

On-module attachment brackets install in panel seams.

Width of overhead storage unit must match the width of the panel or panels that it is attached to.

Additional support for stability may be required when shelves and overhead storage bins are attached to panels. Counterbalancing loads on opposite sides of the panels increases stability.

Tip: See Panel Stability Guidelines.

▶ See Answer Solutions Specification Guide.

Accessories

Wall Hung Channels and Horizontal Braces SIN 711.1

Slotted steel channel can attach to wall of building to accept shelves or overhead storage bins.
▶ Specifying, page B162

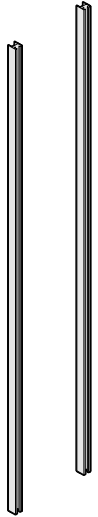

Screw hole positions

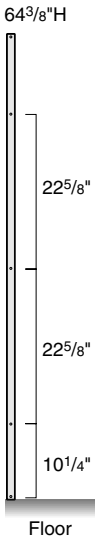

Product Details

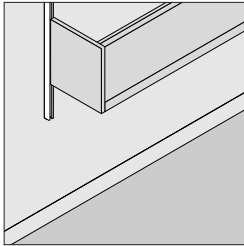

Wall channel can be positioned on wall at height needed.

Connections

Wall channels can be used to support shelves, overhead storage bins, or tackboards. Wall channels can be shared.

Field install:

- Concrete walls with Hilti® type anchors.
- Drywall or plywood with 5/8" thick Toggler® R-type 3/16" wall anchors with countersunk flat head screw.
- Steel or wood studs with #10 sheet metal or wood screws of appropriate length with countersunk flat head screw.

Anchors must be used in each screw hole location on the wall channel.

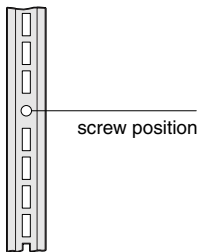

Components attach at 1" increments, but screws block some slot locations.

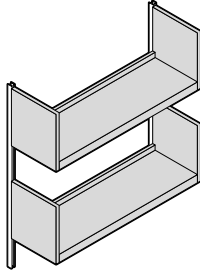

Limit load to two panel-supported components (maximum 150 pounds per component) for each pair of wall channels.

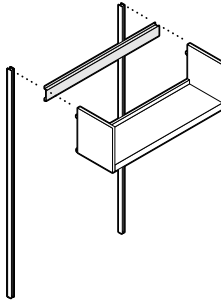

Horizontal brace is available to reinforce vertical wall channels that support storage bins and shelves that are attached to walls. Components that are 36"W or less do not require a horizontal brace.

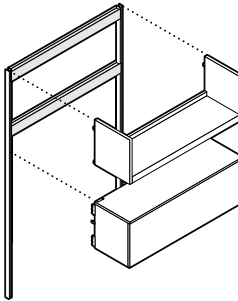

Up to two components can be supported with one horizontal brace. The brace should be positioned at the top of the vertical wall channels. If more than two components must be supported, an additional brace can be added at the appropriate height.

Width of horizontal brace must match width of shelf or storage bin. Brace is not required for applications that involve shelves and bins that are 36"W or less.

Wall hang channels for shelves, overhead storage bins, or tackboards cannot be used with a wall start junction.

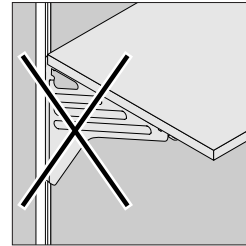

Attaching worksurfaces to wall channels is not possible.

Application Topics

Reinforce wall by positioning studs where wall channels will be attached. See dimensions below.

Distance between center lines of reinforced wall channels matches width of overhead storage unit.

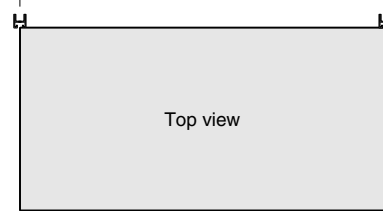

Tip: Wall channels can be shared.

Actual Dimensions

Wall Hang Channels and Horizontal Braces

Depth 1 1/8" (28 mm)

Width 15/16" (24 mm)

Height 66" (1676 mm)

Wall Channels

SIN 711.1

Wall Channels for Universal Bins and Shelves

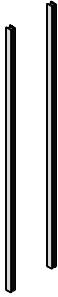

Standard Includes	Required to Specify
<ul style="list-style-type: none">• Pair of channels: paint	<ul style="list-style-type: none">1 Style number2 Paint color number for channels▶ See <i>Surface Materials</i>, page B180.

Specification Information

• Height	• Style Number	• Price
66"	TS7BSWHC	\$49

Horizontal Braces

SIN 711.1

Horizontal Braces

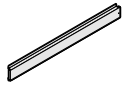

Standard Includes	Required to Specify
<ul style="list-style-type: none"> • Brace: paint 	1 Style number 2 Paint color number for horizontal brace ▶ See <i>Surface Materials</i> , page B180.

Specification Information		
• Width	• Style Number	• Price
42"	TS742HB	\$54
48"	TS748HB	\$54
60"	TS760HB	\$54
72"	TS772HB	\$54
:	:	:

Answer

Dividers

SIN 711.1

Dividers for Overhead Bin and Full-Height Shelf



Standard Includes	Required to Specify
<ul style="list-style-type: none">• Carton of four dividers: clear textured plastic	Style number

Specification Information

• Dimensions			• Style	• Price
D	W	H	Number	
10 ³ / ₄ "	4"	4 ¹ / ₂ "	TS7STDIV	\$35

Universal Curved Front Bins

SIN 711.1

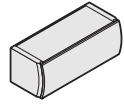

Tip: Basic attachment bracket allows only 12" off-module configurations on panels with vertical attachment. Bin must be the same width or up to 12" wider than the panel.

Tip: Bin is upmountable on Answer panels. Specify with suffix "NON" and choose the upmount bracket option.

Standard Includes	Required to Specify
-------------------	---------------------

- Overhead storage bin: paint price group 1
- Basic attachment bracket: black only
- Lock, keyed random: 9201 Polished Chrome

- 1 Style number with appropriate bracket suffix:
ANS = Answer
NON = NO BASIC BRACKET (see bracket options below)
 2 Paint color number for storage bin
 3 Options, if selected (see below)
 ▶ See *Surface Materials*, page B180.

Options	Price	Required to Specify
---------	-------	---------------------

Surface Materials	<ul style="list-style-type: none"> • Paint price group 1 • Paint price group 2 	No cost +\$ 28	Specify paint color number. Specify paint color number.
Brackets	Upmount <ul style="list-style-type: none"> • Basic upmount bracket • Open design upmount bracket 	+\$ 30 +\$ 95	Specify <i>with basic upmount bracket</i> . Specify <i>with open design upmount bracket</i> .
Lock and Keying	Lock <ul style="list-style-type: none"> • Ember Chrome Keying <ul style="list-style-type: none"> • Factory- and field-installed keying 	No cost	Specify <i>with 9250 Ember Chrome lock</i> . ▶ Page B186
Related Products	<ul style="list-style-type: none"> • Dividers • Stationary shelf • Display shelf • ADA pull 		▶ Page B138 ▶ Page B142 ▶ Page B142 ▶ Page B144

Specification Information

Dimensions			Style	Base
D	W	H	Number	Price

Universal Overhead Bins

16½"	30"	15"	KBIN30L__	\$584
16½"	36"	15"	KBIN36L__	\$642
16½"	42"	15"	KBIN42L__	\$730
16½"	45"	15"	KBIN45L__	\$811
16½"	48"	15"	KBIN48L__	\$811

Answer

Universal Curved Front Bins with Wood Doors

SIN 711.1

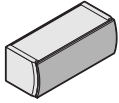

Tip: Only the door is wood. Cabinet is painted metal and end panels are ABS.

Tip: Basic attachment bracket allows only 12" off-module configurations on panels with vertical attachment. Bin must be the same width or up to 12" wider than the panel.

Tip: Bin is upmountable on Answer panels. Specify with suffix "**NON**" and choose the upmount bracket option.

Standard Includes		Required to Specify	
<ul style="list-style-type: none"> Overhead storage bin: paint price group 1 Door: wood Basic attachment bracket: black only Lock, keyed random: 9201 Polished Chrome 		1 Style number with appropriate bracket suffix: ANS = Answer NON = NO BASIC BRACKET (see bracket options below) 2 Paint color number for storage bin 3 Wood color number for door 4 Options, if selected (see below) ▶ See <i>Surface Materials</i> , page B180.	
Options	Price	Required to Specify	
Surface Materials	<ul style="list-style-type: none"> Paint price group 1: No cost Paint price group 2: +\$28 Customiz stain on wood door: +\$20 	Specify paint color number. Specify paint color number. Specify <i>with Customiz stain</i> . ▶ See <i>Surface Materials Reference Manual</i> .	
Brackets	Upmount <ul style="list-style-type: none"> Basic upmount bracket: +\$30 Open design upmount bracket: +\$95 	Specify <i>with basic upmount bracket</i> . Specify <i>with open design upmount bracket</i> .	
Lock and Keying	Lock <ul style="list-style-type: none"> Ember Chrome: No cost Keying <ul style="list-style-type: none"> Factory- and field-installed keying 	Specify <i>with 9250 Ember Chrome lock</i> . ▶ Page B186	
Related Products	<ul style="list-style-type: none"> Dividers Stationary shelf Display shelf ADA pull 	▶ Page B138 ▶ Page B142 ▶ Page B142 ▶ Page B144	

Specification Information

Dimensions			Style	Base
D	W	H	Number	Price

Curved Front Bins with Wood Door

16½"	30"	15"	KBIN30LW__	\$ 834
16½"	36"	15"	KBIN36LW__	\$ 892
16½"	42"	15"	KBIN42LW__	\$ 980
16½"	45"	15"	KBIN45LW__	\$1061
16½"	48"	15"	KBIN48LW__	\$1061

Universal L-Shelves

SIN 711.1

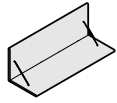

Tip: Basic attachment bracket allows only 12" off-module configurations on panels with vertical attachment. L-shelf must be the same width or up to 12" wider than the panel.

Tip: L-shelf is upmountable on Answer panels. Specify with suffix "**NON**" and choose the upmount bracket option.

Standard Includes		Required to Specify	
	<ul style="list-style-type: none"> Shelf: paint price group 1 Basic attachment bracket: black only Rods: shiny chrome Spacers: 6695 Midnight only Endcaps: 6695 Midnight only 		1 Style number with appropriate bracket suffix: ANS = Answer NON = NO BASIC BRACKET (see bracket options below) 2 Paint color number for shelf 3 Options, if selected (see below) ▶ See <i>Surface Materials</i> , page B180.
Surface Materials	Options	Price	Required to Specify
	<ul style="list-style-type: none"> Paint price group 1 Paint price group 2 	No cost +\$ 25	Specify paint color number. Specify paint color number.
Brackets	Upmount		
	<ul style="list-style-type: none"> Basic upmount bracket Open design upmount bracket 	+\$ 30 +\$ 95	Specify <i>with basic upmount bracket</i> . Specify <i>with open design upmount bracket</i> .
Related Products	<ul style="list-style-type: none"> Dividers Stationary shelf Display shelf 		▶ Page B138 ▶ Page B142 ▶ Page B142

Specification Information

Dimensions			Style	Base
D	W	H	Number	Price
L-Shelf				
14¼"	30"	15"	KLSHF30 __	\$264
14¼"	36"	15"	KLSHF36 __	\$280
14¼"	42"	15"	KLSHF42 __	\$315
14¼"	45"	15"	KLSHF45 __	\$320
14¼"	48"	15"	KLSHF48 __	\$320

Answer

Universal Add-On Shelves

for Curved Front Bin and L-Shelf

SIN 711.1

Stationary Shelf

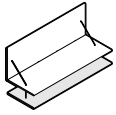

Tip: Stationary shelf hangs 5½" from the bottom of curved front bins and L-shelves. Specify the same width as corresponding bin or L-shelf.

Tip: Stationary shelf cannot hang from an upmounted bin or shelf.

Tip: Shelf is steel with molded endcaps.

Standard Includes		Required to Specify	
-------------------	--	---------------------	--

- Shelf: paint price group 1
- Attachment rods: shiny chrome

- 1 Style number
- 2 Paint color number for shelf
- 3 Options, if selected (see below)
- ▶ See *Surface Materials*, page B180.

Options	Price	Required to Specify
---------	-------	---------------------

Surface Materials	<ul style="list-style-type: none"> • Paint price group 1 • Paint price group 2 	No cost +\$13	Specify paint color number. Specify paint color number.
--------------------------	--	------------------	--

Related Products	<ul style="list-style-type: none"> • Curved front bin • L-shelf 	▶ Pages B139–B140 ▶ Page B141
-------------------------	---	----------------------------------

Specification Information

Dimensions		Style Number	Base Price
D	W		
14"	30"	KSSHF30	\$144
14"	36"	KSSHF36	\$158
14"	42"	KSSHF42	\$172
14"	45"	KSSHF45	\$186
14"	48"	KSSHF48	\$186

Display Shelf

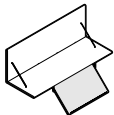

Tip: Display shelf hangs 5½" from the bottom of curved front bins and L-shelves.

Tip: Display shelf will be center-justified on upmounted bin or shelf.

Tip: Display shelf will not attach to an upmounted 30"W bin or shelf.

Standard Includes		Required to Specify	
-------------------	--	---------------------	--

- Shelf: paint price group 1
- Attachment rods: shiny chrome

- 1 Style number
- 2 Paint color number for shelf
- 3 Options, if selected (see below)
- ▶ See *Surface Materials*, page B180.

Options	Price	Required to Specify
---------	-------	---------------------

Surface Materials	<ul style="list-style-type: none"> • Paint price group 1 • Paint price group 2 	No cost +\$13	Specify paint color number. Specify paint color number.
--------------------------	--	------------------	--

Related Products	<ul style="list-style-type: none"> • Curved front bin • L-shelf 	▶ Pages B139–B140 ▶ Page B141
-------------------------	---	----------------------------------

Specification Information

Dimensions		Style Number	Base Price
D	W		
13"	25"	KDISPLAY24	\$186

Bracket Application Rules

for Universal Curved Front Bin and Universal L-Shelf
SIN 711.1

Answer

Bracket Application Matrix

	Basic	Full off-module	Upmount
Answer	•		•
Avenir	•		
Elective Elements	•		
I-Line	•		
Kick	•		•
Montage	•		
Enhanced Off-Module Montage	•	•	
Pathways Technology Wall	•	•	•
Segment		•	
Series 9000	•		

Basic Brackets

Basic brackets are used to mount bins and shelves to panels with vertical slot patterns. Basic attachment brackets push bins and shelves 1/4" from frame.

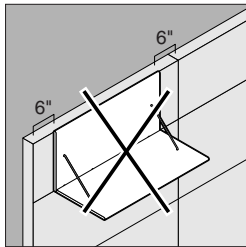

Width of overhead bin or shelf must match or be wider than the width of the panel or panels that it is attached to.

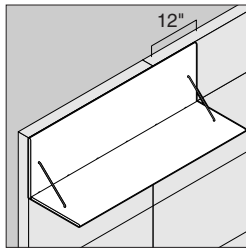

Basic attachment brackets install in panel seams and allow bins and shelves that are wider to be attached. Total width of bin or shelf can extend 12" beyond the bracket on one side.

Upmount Brackets

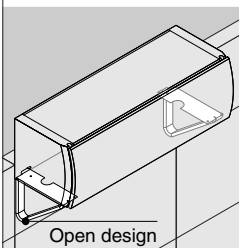
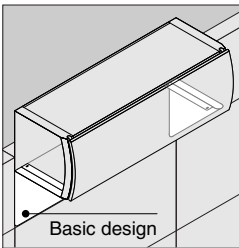

Upmounted bin and shelf height is 66"H when installed on 54"H panels.

Upmount bin or shelf width must match the width of the panel or panels that it attaches to. Upmounted bins and shelves cannot be supported off-module.

Basic and open design upmount brackets, optional, attach bins and shelves near the top of 54"H panels.

Tip: Stationary shelf cannot hang from an upmounted bin or shelf.

Tip: Display shelf will be center-justified on upmounted bin or shelf.

Tip: Display shelf will not attach to an upmounted 30"W bin or shelf.

Accessories

for Curved Front Bin and L-Shelf

SIN 711.1

Bookends

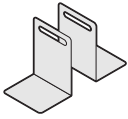

Standard Includes	Required to Specify
-------------------	---------------------

- | | |
|---|--------------|
| • Package of two or twenty bookends: 6695 Midnight only | Style number |
|---|--------------|

Specification Information		
---------------------------	--	--

• Style Number	• Quantity	• Price
KDIV02	2	\$ 19
KDIV20	20	\$185
:	:	:

ADA Pull

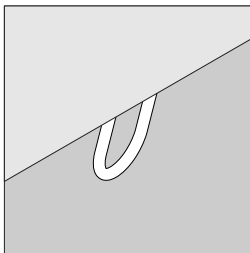

Standard Includes	Required to Specify
-------------------	---------------------

- | | |
|--------------------------------|--------------|
| • ADA pull: 6695 Midnight only | Style number |
|--------------------------------|--------------|

Specification Information	
---------------------------	--

• Style Number	• Price
KPULL	\$34
:	:

Ganging Bracket

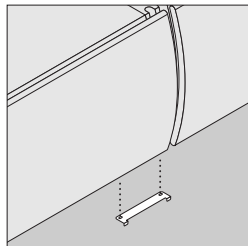

Standard Includes	Required to Specify
-------------------	---------------------

- | | |
|---|--|
| • Package of one or twenty ganging brackets: all paint price groups | 1 Style number number
2 Paint color number
▶ See <i>Surface Materials</i> , page B180. |
|---|--|

Specification Information		
---------------------------	--	--

• Style Number	• Quantity	• Price
KGANG	1	\$ 12
KGANG20	20	\$200
:	:	:

SIN 711.1

Answer Overhead Bins

SIN 711.1

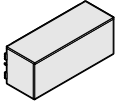

Tip: Oval pull is not available on fabric-covered or wood doors.

Standard Includes		Required to Specify	
<ul style="list-style-type: none"> Overhead bin: paint price group 1 Lock, keyed random: 9201 Polished Chrome 		1 Style number 2 Paint color number for storage bin 3 Options, if selected (see below) ▶ See <i>Surface Materials</i> , page B180.	
Surface Materials	Options	Price	Required to Specify
	Overhead bin		
	• Paint price group 1	No cost	Specify paint color number.
	• Paint price group 2	+\$ 38	Specify paint color number.
	• Paint price group 3	+\$ 65	Specify paint color number.
	Fabric-covered doors on units 24"W to 48"W		
	• Fabric price group 1	+\$120	Specify fabric color number.
	• Fabric price group 2	+\$133	Specify fabric color number.
	• Fabric price group 3	+\$142	Specify fabric color number.
	• Fabric price group 4	+\$152	Specify fabric color number.
	• Fabric price group 5	+\$170	Specify fabric color number.
• Fabric price group COM	+\$150	Specify fabric color number.	
Fabric-covered doors on units 60"W to 72"W			
• Fabric price group 1	+\$180	Specify fabric color number.	
• Fabric price group 2	+\$206	Specify fabric color number.	
• Fabric price group 3	+\$224	Specify fabric color number.	
• Fabric price group 4	+\$244	Specify fabric color number.	
• Fabric price group 5	+\$280	Specify fabric color number.	
• Fabric price group COM	+\$240	Specify fabric color number.	
Wood door front			
• Units 24"W to 48"W	+\$130	Specify <i>with wood door fronts</i> and select wood color number.	
• Customiz stain on wood	+\$ 24	Specify <i>with Customiz stain</i> . ▶ See <i>Surface Materials Reference Manual</i> .	
• Units 60"W and 72"W	+\$180	Specify <i>with wood door fronts</i> and select wood color number.	
• Customiz stain on wood	+\$ 41	Specify <i>with Customiz stain</i> . ▶ See <i>Surface Materials Reference Manual</i> .	
Oval Pull	• Oval pull centered on width of each door: plastic	+\$ 18 price per door	Specify <i>with oval pull</i> and indicate plastic color number: 6000 Black 6654 Sand (Vanadium) 6694 Slate 6695 Midnight 6697 Fog 6698 Fieldstone
Dividers	• Four dividers: clear plastic	+\$ 35	Specify <i>with divider</i> .
Keying	• Factory- and field-installed keying		▶ Page B186
Related Products	• Dividers • Wall channels		▶ Page B161 ▶ Page B162

SIN 711.1

Specification Information						
Dimensions			Number of Doors	Number of Locks	Style Number	Base Price
D	W	H				
16"	24"	15 ¹³ / ₁₆ "	1	1	TS7024BL	\$346
16"	30"	15 ¹³ / ₁₆ "	1	1	TS7030BL	\$362
16"	36"	15 ¹³ / ₁₆ "	1	1	TS7036BL	\$377
16"	42"	15 ¹³ / ₁₆ "	1	1	TS7042BL	\$391
16"	48"	15 ¹³ / ₁₆ "	1	1	TS7048BL	\$413
16"	60"	15 ¹³ / ₁₆ "	2	2	TS7060BL	\$555
16"	72"	15 ¹³ / ₁₆ "	2	2	TS7072BL	\$714

Answer

Answer Shelves

SIN 711.1

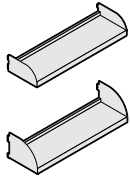

Standard Includes		Required to Specify	
<ul style="list-style-type: none"> Shelf: paint price group 1 		1 Style number 2 Paint color number for shelf 3 Options, if selected (see below) ▶ See <i>Surface Materials</i> , page B180.	

	Options	Price	Required to Specify
Surface Materials	<ul style="list-style-type: none"> Paint price group 1 Paint price group 2 Paint price group 3 	No cost +\$13 +\$21	Specify paint color number. Specify paint color number. Specify paint color number.
Dividers	<ul style="list-style-type: none"> Four dividers: clear plastic 	+\$35	Specify <i>with divider</i> .
Related Products	<ul style="list-style-type: none"> Dividers Wall channels 		▶ Page B161 ▶ Page B162

Specification Information				
Dimensions	Style		Base Price	
	D	W		

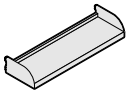

Half-Height Shelves

15¼"	24"	7½"	TS7024SH	\$129
15¼"	30"	7½"	TS7030SH	\$132
15¼"	36"	7½"	TS7036SH	\$142
15¼"	42"	7½"	TS7042SH	\$151
15¼"	48"	7½"	TS7048SH	\$163
15¼"	60"	7½"	TS7060SH	\$183
15¼"	72"	7½"	TS7072SH	\$205

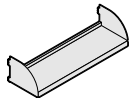

Full-Height Shelves

15¼"	24"	12¾"	TS7024S	\$129
15¼"	30"	12¾"	TS7030S	\$132
15¼"	36"	12¾"	TS7036S	\$142
15¼"	42"	12¾"	TS7042S	\$151
15¼"	48"	12¾"	TS7048S	\$163
15¼"	60"	12¾"	TS7060S	\$183
15¼"	72"	12¾"	TS7072S	\$205

SIN 711.1

Answer Fixed Pedestals

SIN 711.1



Standard Includes	Required to Specify
<ul style="list-style-type: none"> • Pedestal and filler, when specified: paint price group 1 • Oval pulls: plastic • Basic drawer interiors: black only <ul style="list-style-type: none"> —Full-depth drawer bodies —Box drawers with full extensions —File drawers with full extensions —No drawer accessories • Lock, keyed random: 9201 Polished Chrome • Four adjustable leveling glides: black only 	<ol style="list-style-type: none"> 1 Style number 2 Paint color number for pedestal and filler, if selected 3 Plastic color number for oval pulls: <ul style="list-style-type: none"> 6000 Black 6654 Sand (Vanadium) 6694 Slate 6695 Midnight 6697 Fog 6698 Fieldstone 4 Options, if selected (see below) <ul style="list-style-type: none"> ▶ See <i>Surface Materials</i>, page B180.

Tip: Oval pulls are not available on pedestals with wood drawer fronts.

Options	Price	Required to Specify
Surface Materials <ul style="list-style-type: none"> • Paint price group 1 • Paint price group 2 • Paint price group 3 	<ul style="list-style-type: none"> No cost +\$ 38 +\$ 65 	<ul style="list-style-type: none"> Specify paint color number. Specify paint color number. Specify paint color number.
Pulls <ul style="list-style-type: none"> • Contemporary pulls • Handle pulls 	<ul style="list-style-type: none"> +\$ 20 +\$ 20 	<ul style="list-style-type: none"> Specify <i>with contemporary pulls</i> and select metal pull color number: <ul style="list-style-type: none"> 0835 Black 9201 Polished Chrome 9211 Nickel 9212 Silver Specify <i>with handle pulls</i> and select metal pull color number: <ul style="list-style-type: none"> 0835 Black 9201 Polished Chrome 9211 Nickel 9212 Silver
Wood Drawer Fronts <ul style="list-style-type: none"> • Wood drawer fronts • Customiz stain on wood 	<ul style="list-style-type: none"> +\$195 +\$ 12 	<ul style="list-style-type: none"> Specify <i>with wood drawer fronts</i> and select wood color number. Specify <i>with Customiz stain</i>. ▶ See <i>Surface Materials Reference Manual</i>.
Full Drawer Interiors <ul style="list-style-type: none"> • Full-depth drawers, full drawer extensions, pencil tray, and box drawer dividers 	<p>24"D and 30"D box/box/file pedestals</p> <ul style="list-style-type: none"> +\$ 35 	<ul style="list-style-type: none"> Specify <i>with full drawers</i>.
Lock and Keying <ul style="list-style-type: none"> • Ember Chrome • No lock 	<p>Lock</p> <ul style="list-style-type: none"> No cost -\$50 	<ul style="list-style-type: none"> Specify <i>with 9250 Ember Chrome lock</i>. Specify <i>with no lock</i>.
<ul style="list-style-type: none"> • File/file pedestals only 	<p>Individual locking drawers</p> <ul style="list-style-type: none"> +\$95 	<ul style="list-style-type: none"> Specify <i>with individual drawer lock</i>.
<ul style="list-style-type: none"> • Factory- and field-installed keying 	<p>Keying</p>	<ul style="list-style-type: none"> ▶ Page B186
Related Products <ul style="list-style-type: none"> • Storage accessories 		<ul style="list-style-type: none"> ▶ Page B156

Specification Information

Dimensions			Style	Base
D	W	H	Number	Price

Two Box and One File Drawer

23½"	15"	27"	TU720BBFL	\$411
29½"	15"	27"	TU726BBFL	\$478

Two File Drawers

23½"	15"	27"	TU720FFL	\$411
29½"	15"	27"	TU726FFL	\$478

Pedestal Fillers

Dimensions			Style	U.S.
D	W	H	Number	Base Price

½"	N.A.	27"	RPXFTAKPP	\$45
----	------	-----	------------------	------

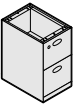

Tip: Pedestal fillers can be used to aesthetically close the ½" gap that may exist behind the pedestal or structurally connect the pedestal to the panel.

Tip: If a pedestal filler is needed for Answer pedestals manufactured prior to February 2004, specify Answer fillers.

▶ Page B156

Answer Mobile Pedestals

SIN 711.1



Tip: 1/8"H steel top is non-structural.

Tip: Oval pulls are not available on pedestals with wood drawer fronts.

Standard Includes	Required to Specify
<ul style="list-style-type: none"> • Pedestal: paint price group 1 • 1/8"H steel top: paint to match pedestal • Oval pulls: plastic • Basic drawer interiors: black only <ul style="list-style-type: none"> —Full-depth drawer bodies —Box drawers with full extensions —File drawers with full extensions —No drawer accessories • Lock, keyed random: 9201 Polished Chrome • Four hard-composition, non-locking, casters: black only • Counterweight package 	<ol style="list-style-type: none"> 1 Style number 2 Paint color number for pedestal 3 Plastic color number for oval pulls: <ul style="list-style-type: none"> 6000 Black 6654 Sand (Vanadium) 6694 Slate 6695 Midnight 6697 Fog 6698 Fieldstone 4 Options, if selected (see below) <ul style="list-style-type: none"> ▶ See <i>Surface Materials</i>, page B180.

Options	Price	Required to Specify
Surface Materials <ul style="list-style-type: none"> • Paint price group 1 • Paint price group 2 • Paint price group 3 	<ul style="list-style-type: none"> No cost +\$ 38 +\$ 65 	<ul style="list-style-type: none"> Specify paint color number. Specify paint color number. Specify paint color number.
Pulls <ul style="list-style-type: none"> • Contemporary pulls • Handle pulls 	<ul style="list-style-type: none"> +\$ 20 +\$ 20 	<ul style="list-style-type: none"> Specify <i>with contemporary pulls</i> and select metal pull color number: <ul style="list-style-type: none"> 0835 Black 9201 Polished Chrome 9211 Nickel 9212 Silver Specify <i>with handle pulls</i> and select metal pull color number: <ul style="list-style-type: none"> 0835 Black 9201 Polished Chrome 9211 Nickel 9212 Silver
Wood Drawer Fronts <ul style="list-style-type: none"> • Wood drawer fronts • Customiz stain on wood 	<ul style="list-style-type: none"> +\$195 +\$ 12 	<ul style="list-style-type: none"> Specify <i>with wood drawer fronts</i> and select wood color number. Specify <i>with Customiz stain</i>. ▶ See <i>Surface Materials Reference Manual</i>.
Full Drawer Interiors <ul style="list-style-type: none"> • 24"D box/file and box/box/file pedestals • Full-depth drawers, full drawer extensions, pencil tray, and box drawer dividers 	<ul style="list-style-type: none"> +\$ 35 	<ul style="list-style-type: none"> Specify <i>with full drawers</i>.
Lock and Keying <ul style="list-style-type: none"> • Lock • Ember Chrome • Individual locking drawers • File/file pedestals only • Keying • Factory- and field-installed keying 	<ul style="list-style-type: none"> No cost +\$95 	<ul style="list-style-type: none"> Specify <i>with 9250 Ember Chrome lock</i>. Specify <i>with individual drawer lock</i>. ▶ Page B186
Tops <ul style="list-style-type: none"> • Cushion top for factory installation on TU7MOBILE only • Cushion top without handle • Cushion top with 9201 Polished Chrome handle 	<ul style="list-style-type: none"> +\$230 +\$300 	<ul style="list-style-type: none"> Specify <i>with cushion top</i> and indicate fabric color number. Specify <i>with cushion top and handle</i> and indicate fabric color number.

▶ Options continued on next page

► Options continued from previous page

Options	Price	Required to Specify
Tops (continued)	Upholstery on pedestal cushion top	
• Fabric price group 1	No cost	Specify fabric color number.
• Fabric price group 2	+\$ 10	Specify fabric color number.
• Fabric price group 3	+\$ 33	Specify fabric color number.
• Fabric price group 4	+\$ 41	Specify fabric color number.
• Fabric price group 5	+\$ 50	Specify fabric color number.
• Fabric price group 6	+\$ 72	Specify fabric color number.
• Fabric price group 7	+\$ 85	Specify fabric color number.
• Fabric price group 8	+\$125	Specify fabric color number.
• Fabric price group 9	+\$160	Specify fabric color number.
• Fabric price group 10	+\$195	Specify fabric color number.
• Leather price group	+\$500	Specify leather color number.
• Customer's own material (COM) or Customer's own leather (COL)	+\$ 15	► See <i>Surface Materials</i> , page B180. ► See <i>Surface Materials Reference Manual</i> to specify.
Related Products	• Storage accessories	► Page B156

Specification Information

Dimensions			Style	Base
D	W	H	Number	Price

One Box and One File Drawer with Laminate Top

23½"	15"	21"	TU7MOBILE	\$663
------	-----	-----	------------------	-------

Two Box and One File Drawer with Steel Top

23½"	15"	27"	TU7BBFM	\$757
------	-----	-----	----------------	-------

Two File Drawers with Steel Top

23½"	15"	27"	TU7FFM	\$740
------	-----	-----	---------------	-------

Pedestal Cushion Top for Field Installation on TU7MOBILE only

Actual Dimensions			Style	Base
D	W	H	Number	Price

Cushion Top without Handle

23½"	15"	2¼"	RPXTC24P	\$230
------	-----	-----	-----------------	-------

Cushion Top with 9201 Polished Chrome Handle

23½"	15"	2¼"	RPXTCH24P	\$300
------	-----	-----	------------------	-------



Answer

Answer Mobile Pedestal Cap

Field-Installed Kit

SIN 711.1

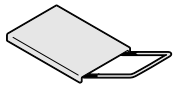

Tip: For use with "TS7" Series Answer pedestals manufactured prior to February 2004.

Standard Includes	Required to Specify
<ul style="list-style-type: none"> Cushion upholstery: fabric price group 1 Retractable handle: 9201 Polished Chrome only Template for installation 	<ol style="list-style-type: none"> Style number Fabric color number for cushion upholstery Options, if selected (see below) <p>▶ See <i>Surface Materials</i> in the electronic price list.</p>

Options		Price	Required to Specify
Surface Materials	Upholstery		
	<ul style="list-style-type: none"> Fabric price group 1 Fabric price group 2 Fabric price group 3 Fabric price group 4 Fabric price group 5 Fabric price group 6 Fabric price group 7 Fabric price group 8 Fabric price group 9 Fabric price group 10 Leather price group 	No cost +\$ 10 +\$ 33 +\$ 41 +\$ 50 +\$ 72 +\$ 85 +\$125 +\$160 +\$195 +\$500	Specify fabric color number. Specify fabric color number. Specify fabric color number. Specify fabric color number. Specify fabric color number. Specify fabric color number. Specify fabric color number. Specify fabric color number. Specify fabric color number. Specify fabric color number. Specify leather color number. ▶ See <i>Surface Materials</i> in the electronic price list. ▶ See <i>Surface Materials Reference Manual</i> to specify.
	<ul style="list-style-type: none"> Customer's own material (COM) or Customer's own leather (COL) 	+\$ 15	

Specification Information			
•Dimensions		•Style	•Base
D	W	Number	Price

For Use with Answer Box File Mobile Pedestal (TS7MOBILE)

22"	15"	CAP1520	\$299
:	:	:	:

Storage Accessories

SIN 711.1

Answer Filler

For Use with Answer System Panels and Worksurfaces

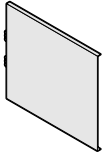

Standard Includes	Required to Specify
<ul style="list-style-type: none"> • Filler: paint 	1 Style number 2 Paint color number for filler ▶ See <i>Surface Materials</i> , page B180.

Specification Information

Depth	Style Number	Price
Filler to Close Gap Between Back of Panel or Lateral File		
24"	TS724FLR	\$36
30"	TS730FLR	\$36
⋮	⋮	⋮

Answer Filler

For Use with Answer Underworksurface Lateral Files

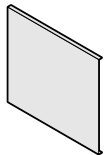

Standard Includes	Required to Specify
<ul style="list-style-type: none"> • Filler: paint 	1 Style number 2 Paint color number for filler ▶ See <i>Surface Materials</i> , page B180.

Specification Information

Depth	Style Number	Price
On-Module		
24"	UPF24	\$36
30"	UPF30	\$36
⋮	⋮	⋮

Tip: For use with Answer underworksurface lateral files and Answer pedestals manufactured prior to February 2004.

Pedestal Attachment Cable



Tip: For use with Answer underworksurface lateral files.

Standard Includes	Required to Specify
<ul style="list-style-type: none"> • Pedestal attachment cable • Package of 1 or 25 	Style number

Specification Information

Style Number	Price
PAB12 (package of 1)	\$ 9
PAB12M (package of 25)	\$195

Pencil Trays

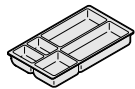

Standard Includes	Required to Specify
<ul style="list-style-type: none"> • Pencil tray: black plastic only 	Style number

Specification Information

Style Number	Price
Use with 20"D and 26"D Pedestals and 20"D Mobile Pedestals	
TS7BDPT	\$20
Use with 24"D and 30"D Pedestals	
99465	\$21

Pencil Tray

For Use with 22"D Mobile Pedestals

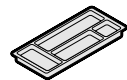

Standard Includes	Required to Specify
<ul style="list-style-type: none"> • Pencil tray: black plastic only 	Style number

Specification Information

Style Number	Price
TS2PPT	\$10

Note: This product is Turnstone **not** Steelcase. It is included here to simplify your planning. Remember that Steelcase has different pricing terms than Turnstone products.

Storage Accessories, continued

SIN 711.1

Rail

For Use with 24"D and 30"D Pedestals

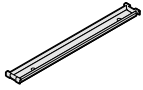

Standard Includes	Required to Specify
<ul style="list-style-type: none"> Rail: black paint only 	Style number

Specification Information

• Dimensions			• Style	• Price
D	W	H	Number	
1"	12¼"	½"	BPR	\$12

Dividers

For Use with 22"D Mobile Pedestals

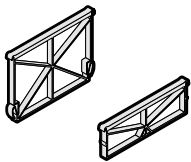

Standard Includes	Required to Specify
<ul style="list-style-type: none"> Divider/rail: black plastic only 	Style number

Specification Information

• Dimensions			• Style	• Price
D	W	H	Number	

Use with Box Drawers

¾"	12¾"	4¾"	TS2PBDD	\$ 5
----	------	-----	----------------	------

Use with File Drawers

¾"	12¾"	9¾"	TS2PFDD	\$10
----	------	-----	----------------	------

Note: This product is Turnstone **not** Steelcase. It is included here to simplify your planning. Remember that Steelcase has different pricing terms than Turnstone products.

Dividers

For Use with Lateral Files



Standard Includes	Required to Specify
<ul style="list-style-type: none"> Carton of three dividers: black paint only 	Style number

Specification Information

• Style Number	• Price
TS200DV12	\$17

Note: This product is Turnstone **not** Steelcase. It is included here to simplify your planning. Remember that Steelcase has different pricing terms than Turnstone products.

Adjustable Rails

For Use with Lateral Files

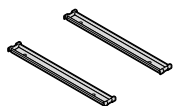

Standard Includes	Required to Specify
<ul style="list-style-type: none"> • Pair of adjustable rails to accommodate front-to-back filing: black paint only 	Style number

Specification Information

Style Number	Price
800RW	\$21
:	:

Counterweight Packages

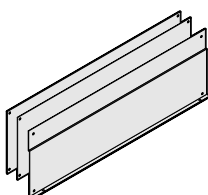

Tip: To ensure cabinet stability, field install counterweight packages for lateral files that are not ganged to another case, attached to a worksurface, or bolted to the floor or wall.

Standard Includes	Required to Specify
<ul style="list-style-type: none"> • Front and back counterweight plates • Attachment hardware • Installation directions 	Style number

Specification Information

Cabinet Width	Style Number	Price
For Use in 27¹/₄"H (2-Drawer) Files Without Top		
All widths	GSCLCW	\$ 87
For Use in 28⁵/₈"H (2-Drawer) Closed Top Lateral Files		
30"	847CW	\$103
36"	858CW	\$113
42"	858CW	\$113
For Use in 40⁵/₈"H (3-Drawer) Closed Top Lateral Files		
30"	837CW	\$ 93
36"	847CW	\$103
42"	858CW	\$113
For Use in 53¹/₄"H (4-Drawer) Closed Top Lateral Files		
30"	827CW	\$ 82
36"	837CW	\$ 93
42"	847CW	\$103
For Use in 65¹/₄"H (5-Drawer) Lateral Files		
30"	827CW	\$ 82
36"	827CW	\$ 82
42"	827CW	\$ 82
:	:	:

Storage Accessories, continued

SIN 711.1

Hanging File Folder Frames

For Use with Answer Lateral Files

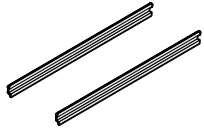

Note: This product is Turnstone **not** Steelcase. It is included here to simplify your planning. Remember that Steelcase has different pricing terms than Turnstone products.

Standard Includes	Required to Specify
-------------------	---------------------

- Hanging file folder frame: black paint only

Style number

Specification Information		
---------------------------	--	--

• Drawer Width	• Style Number	• Price
30"	130HF	\$10
36"	136HF	\$10
42"	142HF	\$10
:	:	:

Flexible Markerboard Surfaces for Binder Bins

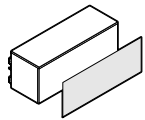

Standard Includes	Required to Specify
-------------------	---------------------

- Flexible, self-adhesive markerboard surface to attach to door of overhead storage bin: white plastic

Style number

Specification Information			
---------------------------	--	--	--

• Width	• Height	• Style Number	• Price
30"	15"	TS71530MBB	\$81
36"	15"	TS71536MBB	\$85
42"	15"	TS71542MBB	\$89
48"	15"	TS71548MBB	\$94
:	:	:	:

Brackets to Attach Avenir Bins and Shelves to Answer Panels

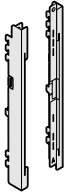

Tip: Brackets only work on Avenir bins and shelves manufactured since May 1997. Bins and shelves manufactured prior to this date would require brackets manufactured through Specials.

Tip: Avenir binder bins cannot hang on a stacked segment of an Answer panel.

Standard Includes	Required to Specify
<ul style="list-style-type: none"> • Pair of brackets: paint 	1 Style number 2 Paint color number for brackets ▶ See <i>Surface Materials</i> , page B180.

Specification Information

• Style Number	• Price
Use with Avenir Bin with Flush Door	
TS7AV	\$125
Use with Avenir Bin with Integral Door and Avenir Full-Height Shelves with Radius and Square End Supports	
TS7BM	\$125
Use with Avenir Half-Height Shelves with Square End Supports	
TS7AVH	\$125
Use with Avenir Half-Height Shelves with Radius End Supports	
TS7BMH	\$125

Dividers for Shelves and Overhead Storage Bins



Standard Includes	Required to Specify
<ul style="list-style-type: none"> • Carton of four dividers: clear textured plastic 	Style number

Specification Information

• Dimensions			• Style Number	• Price
D	W	H		
10 ³ / ₄ "	4"	4 ¹ / ₂ "	TS7STDIV	\$35

Storage Accessories, continued

SIN 711.1

Wall Channels for Shelves, Overhead Storage Bins, and Tackboards

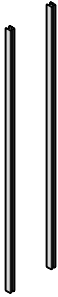

Standard Includes	Required to Specify
<ul style="list-style-type: none"> • Pair of channels: paint 	1 Style number 2 Paint color number for channels ▶ See <i>Surface Materials</i> , page B180.

Specification Information		
Height	Style Number	Price
66"	TS7BSWHC	\$49
:	:	:

Horizontal Braces

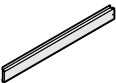

Standard Includes	Required to Specify
<ul style="list-style-type: none"> • Brace: paint 	1 Style number 2 Paint color number for horizontal brace ▶ See <i>Surface Materials</i> , page B180.

Specification Information		
Width	Style Number	Price
42"	TS742HB	\$54
48"	TS748HB	\$54
60"	TS760HB	\$54
72"	TS772HB	\$54
:	:	:

Markerboard



Note: This product is Turnstone **not** Steelcase. It is included here to simplify your planning. Remember that Steelcase has different pricing terms than Turnstone products.

Standard Includes	Required to Specify
<ul style="list-style-type: none"> • Markerboard: white laminate 	Style number

Specification Information				
Dimensions			Style Number	Price
D	W	H	Number	
1"	28"	35"	TS40007	\$195
:	:	:	:	:

Tackboard



Note: This product is Turnstone **not** Steelcase. It is included here to simplify your planning. Remember that Steelcase has different pricing terms than Turnstone products.

Standard Includes	Required to Specify
<ul style="list-style-type: none"> Tackboard: black fabric 	Style number

Specification Information

• Dimensions			• Style	• Price
D	W	H	Number	
1"	28"	35"	TS40008	\$169

Hanging Kit for Markerboard or Tackboard

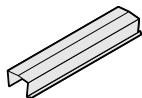

Standard Includes	Required to Specify
<ul style="list-style-type: none"> Hanging kit: black paint only 	Style number

Specification Information

• Width	• Style	• Price
	Number	
17 ³ / ₄ "	TS7MTPK	\$23

Specifying Steelcase Lighting Used with Answer

► For more detailed product information, see the *Answer Solutions Specification Guide* or consult your Steelcase dealer.

Lighting

Canopy Lights (SIN 711.1)	B166
Rail-Mounting Riser (SIN 711.1)	B170
Advanced Shelf Lights (SIN 711.1)	B172
Standard Shelf Lights (SIN 711.1)	B174
Utility Shelf Lights (SIN 711.1)	B176

Related Products

Vertical Wire Manager (SIN 711.1)	B178
-----------------------------------	-------------

Canopy Lights

for Use with 3/4"- to 1 3/4"-Thick Worksurfaces

SIN 711.1

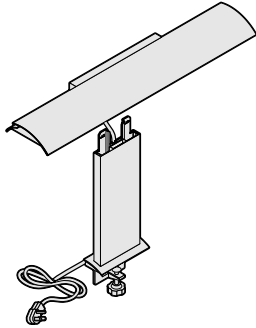

Standard Includes	Required to Specify
-------------------	---------------------

- Light housing: all paint price groups or clear anodized aluminum
- Light control box and end caps: Sterling plastic only
- On-off switch centered in control box
- 9' cord with three-prong plug at 45° angle: black vinyl only
- Precision optics tube
- Reflector: specular (reflective) aluminum
- T5 3500K lamp
- Electronic ballast
- Dimmer switch, if selected: Sterling plastic only
- Clamp mechanism
- Pair of cord manager clips: black plastic only

- 1 Style number
- 2 Paint color number or 8043 Clear Anodized Aluminum for light housing
- ▶ See *Surface Materials*, page B180.

Specification Information					
Dimensions			Lamp	Style	Price
D	W	H	Wattage	Number	

Electronic Ballast with Dimmer Switch

7 1/16"	24 1/4"	3 13/16"	14 watts	LCS24KR	\$550
7 1/16"	36 1/16"	3 13/16"	21 watts	LCS36KR	\$581
7 1/16"	47 7/8"	3 13/16"	28 watts	LCS48KR	\$613

With Chicago Cord Including Circuit Breaker

7 1/16"	24 1/4"	3 13/16"	14 watts	LCS24KRC	\$597
7 1/16"	36 1/16"	3 13/16"	21 watts	LCS36KRC	\$628
7 1/16"	47 7/8"	3 13/16"	28 watts	LCS48KRC	\$660

Electronic Ballast

7 1/16"	24 1/4"	3 13/16"	14 watts	LCS24K	\$475
7 1/16"	36 1/16"	3 13/16"	21 watts	LCS36K	\$506
7 1/16"	47 7/8"	3 13/16"	28 watts	LCS48K	\$538

With Chicago Cord Including Circuit Breaker

7 1/16"	24 1/4"	3 13/16"	14 watts	LCS24KC	\$522
7 1/16"	36 1/16"	3 13/16"	21 watts	LCS36KC	\$553
7 1/16"	47 7/8"	3 13/16"	28 watts	LCS48KC	\$585

Canopy Lights

SIN 711.1

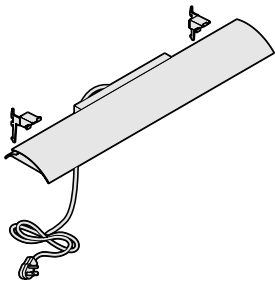

*Tip: Panel-mounted canopy lights are standard with brackets that attach to Answer, Avenir, and Series 9000 panels. You **must** select the correct brackets for use on Elective Elements, Montage, slatwall, architectural drywall, or competitive products.*

Standard Includes	Required to Specify
<ul style="list-style-type: none"> Light housing: all paint price groups or clear anodized aluminum Light control box and end caps: Sterling plastic only On-off switch centered in control box 9' cord with three-prong plug at 45° angle: black vinyl only Precision optics tube Reflector: specular (reflective) aluminum T5 3500K lamp Electronic ballast Dimmer switch, if selected: Sterling plastic only Pair of Answer, Avenir, and Series 9000 panel-mounting brackets: Sterling paint only Pair of cord manager clips: black plastic only 	<ol style="list-style-type: none"> Style number Paint color number or 8043 Clear Anodized Aluminum for light housing Options, if selected (see below) <ul style="list-style-type: none"> ▶ See <i>Surface Materials</i>, page B180.

Options	Price	Required to Specify
Panel Brackets <ul style="list-style-type: none"> Pair of Elective Elements panel-mounting brackets: Sterling paint only 	No cost	Specify with <i>Elective Elements</i> brackets.
<ul style="list-style-type: none"> Pair of Montage frame-mounting brackets: Sterling paint only 	No cost	Specify with <i>Montage</i> brackets.
Slatwall Brackets <ul style="list-style-type: none"> Pair of slatwall-mounting brackets: Sterling paint only 	No cost	Specify with <i>slatwall</i> brackets.
Architectural Drywall Brackets <ul style="list-style-type: none"> Pair of architectural drywall brackets: Sterling paint only 	No cost	Specify with <i>drywall</i> brackets.
Competitive Brackets <ul style="list-style-type: none"> Pair of panel-mounted brackets for use with Haworth Premise: Sterling paint only 	No cost	Specify with <i>Haworth Premise</i> brackets.
<ul style="list-style-type: none"> Pair of panel-mounted brackets for use with Herman Miller Action Office: Sterling paint only 	No cost	Specify with <i>Herman Miller Action Office</i> brackets.
<ul style="list-style-type: none"> Pair of panel-mounted brackets for use with Herman Miller Ethospace: Sterling paint only 	No cost	Specify with <i>Herman Miller Ethospace</i> brackets.
<ul style="list-style-type: none"> Pair of panel-mounted brackets for use with Knoll System 6 and System Z: Sterling paint only 	No cost	Specify with <i>Knoll System 6 and System Z</i> brackets.
Related Products <ul style="list-style-type: none"> Rail-mounting riser 		▶ Page B170

Specification Information

Dimensions			Lamp	Style	Base
D	W	H	Wattage	Number	Price

Electronic Ballast with Dimmer Switch

7 1/16"	24 1/4"	3 13/16"	14 watts	LCP24KR	\$470
7 1/16"	36 1/16"	3 13/16"	21 watts	LCP36KR	\$501
7 1/16"	47 7/8"	3 13/16"	28 watts	LCP48KR	\$533

With Chicago Cord Including Circuit Breaker

7 1/16"	24 1/4"	3 13/16"	14 watts	LCP24KRC	\$517
7 1/16"	36 1/16"	3 13/16"	21 watts	LCP36KRC	\$548
7 1/16"	47 7/8"	3 13/16"	28 watts	LCP48KRC	\$580

Electronic Ballast

7 1/16"	24 1/4"	3 13/16"	14 watts	LCP24K	\$395
7 1/16"	36 1/16"	3 13/16"	21 watts	LCP36K	\$426
7 1/16"	47 7/8"	3 13/16"	28 watts	LCP48K	\$458

With Chicago Cord Including Circuit Breaker

7 1/16"	24 1/4"	3 13/16"	14 watts	LCP24KC	\$442
7 1/16"	36 1/16"	3 13/16"	21 watts	LCP36KC	\$473
7 1/16"	47 7/8"	3 13/16"	28 watts	LCP48KC	\$505

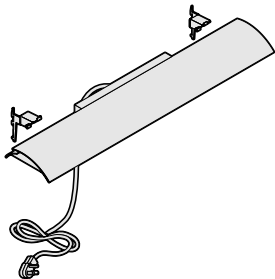
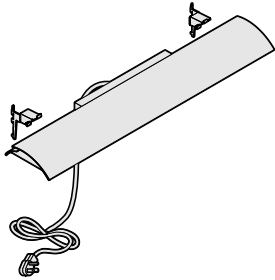

Rail-Mounting Riser

SIN 711.1



Tip: For more information about Details Workflo rail, call Details Customer Alliance at 1.800.833.0411.

Standard Includes	Required to Specify
-------------------	---------------------

- | | |
|--|--------------|
| <ul style="list-style-type: none">• Riser to attach to Details Workflo: Sterling plastic only• Pair of cord manager clips: black plastic only | Style number |
|--|--------------|

Specification Information				
• Dimensions			• Style	• Price
D	W	H	Number	

1"	6"	6½"	LCWRIS	\$55
----	----	-----	---------------	------

SIN 711.1

Advanced Shelf Lights

SIN 711.1

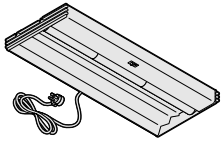

Tip: Daisy chaining is not allowed in New York City or Chicago. Local electrical codes vary, so you should consult a qualified electrical contractor or engineer for proper installation of all electrical equipment.

Tip: Because shelf lights are usually recessed, black is the standard paint color. Paint colors other than black have an upcharge.

Tip: If an optional paint color is selected for the housing, the electrical switches and end caps will remain black plastic.

Standard Includes	Required to Specify
-------------------	---------------------

- Light housing with centered on-off switch: black paint
- End cap cord managers: black plastic only
- Cords:
 - 9' cord with three-prong plug at 45° angle: black vinyl only
 - One 30" and one 48" cord with modular connectors for daisy chaining: black vinyl only
- Precision optics tube around lamp
- Faceted reflector: specular (reflective) aluminum
- T8 3500K lamp
- Ballast
- Dimmer switch, if selected: black plastic only
- Universal mounting hardware package
- Daisy chain starter cord, if selected: black vinyl only (order separately)

- 1 Style number
 - 2 Paint color number, if other than black (see options below)
 - 3 Options, if selected (see below)
- ▶ See *Surface Materials*, page B180.

Options	Price	Required to Specify
Surface Materials <ul style="list-style-type: none"> • Painted light housing other than black 	+\$15	Specify paint color number for housing. ▶ See paint color listed in <i>Surface Materials</i> , page B180.
Bracket Option <ul style="list-style-type: none"> • Competitive mounting package • Flush mounting package 	No cost No cost	Specify <i>with competitive mounting package</i> . Specify <i>with flush mounting package</i> and paint color number for end cap covers.

Specification Information

• Dimensions			• Lamp	• Style	• Base
D	W	H	Wattage	Number	Price

Economizer Electronic Ballast

9 1/4"	25"	1 3/4"	17 watts	LSH24KF	\$412
9 1/4"	37"	1 3/4"	25 watts	LSH36KF	\$439
9 1/4"	49"	1 3/4"	32 watts	LSH48KF	\$458

With Chicago Cord Including Circuit Breaker

9 1/4"	25"	1 3/4"	17 watts	LSH24KFC	\$459
9 1/4"	37"	1 3/4"	25 watts	LSH36KFC	\$486
9 1/4"	49"	1 3/4"	32 watts	LSH48KFC	\$505

With Daisy Chain Cords

9 1/4"	25"	1 3/4"	17 watts	LSH24KFD	\$436
9 1/4"	37"	1 3/4"	25 watts	LSH36KFD	\$463
9 1/4"	49"	1 3/4"	32 watts	LSH48KFD	\$482

▶ **Specification information continued on next page**

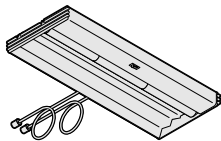
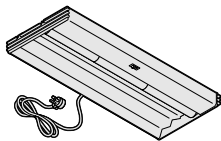

Tip: Remember to order a daisy chain starter cord.
▶ See *Related Products* on next page.

Specification Information

• Dimensions			• Lamp Wattage	• Style Number	• Base Price
D	W	H			

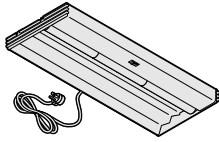

Electronic Ballast

9 1/4"	25"	1 3/4"	17 watts	LSH24K	\$373
9 1/4"	37"	1 3/4"	25 watts	LSH36K	\$400
9 1/4"	49"	1 3/4"	32 watts	LSH48K	\$419

With Chicago Cord Including Circuit Breaker

9 1/4"	25"	1 3/4"	17 watts	LSH24KC	\$420
9 1/4"	37"	1 3/4"	25 watts	LSH36KC	\$447
9 1/4"	49"	1 3/4"	32 watts	LSH48KC	\$466

With Daisy Chain Cords

9 1/4"	25"	1 3/4"	17 watts	LSH24KD	\$397
9 1/4"	37"	1 3/4"	25 watts	LSH36KD	\$424
9 1/4"	49"	1 3/4"	32 watts	LSH48KD	\$443

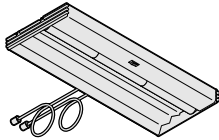

Tip: Remember to order a daisy chain starter cord.

▶ See Related Products below.

Electronic Ballast with Dimmer Switch

9 1/4"	25"	1 3/4"	17 watts	LSH24KR	\$465
9 1/4"	37"	1 3/4"	25 watts	LSH36KR	\$492
9 1/4"	49"	1 3/4"	32 watts	LSH48KR	\$511

With Chicago Cord Including Circuit Breaker

9 1/4"	25"	1 3/4"	17 watts	LSH24KRC	\$512
9 1/4"	37"	1 3/4"	25 watts	LSH36KRC	\$539
9 1/4"	49"	1 3/4"	32 watts	LSH48KRC	\$558

With Daisy Chain Cords

9 1/4"	25"	1 3/4"	17 watts	LSH24KDR	\$489
9 1/4"	37"	1 3/4"	25 watts	LSH36KDR	\$516
9 1/4"	49"	1 3/4"	32 watts	LSH48KDR	\$535

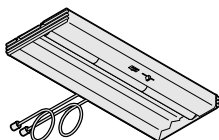
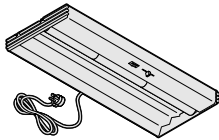

Tip: Remember to order a daisy chain starter cord.

▶ See Related Products below.

Related Products

• Quantity in Package	• Length	• Style Number	• Base Price
-----------------------	----------	----------------	--------------

Daisy Chain Starter Cord

1	78"	LS1FSC	\$ 40
6	78"	LS6FSC	\$240



Standard Shelf Lights

SIN 711.1

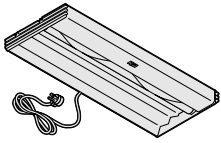

Tip: Daisy chaining is not allowed in New York City or Chicago. Local electrical codes vary, so you should consult a qualified electrical contractor or engineer for proper installation of all electrical equipment.

Tip: Because shelf lights are usually recessed, black is the standard paint color. Paint colors other than black have an upcharge.

Tip: If an optional paint color is selected for the housing, the electrical switches and end caps will remain black plastic.

Standard Includes	Required to Specify
-------------------	---------------------

- Light housing with centered on-off switch: black paint
- End cap cord managers: black plastic only
- Cords:
 - 9' cord with three-prong plug at 45° angle: black vinyl only
 - One 30" and one 48" cord with modular connectors for daisy chaining: black vinyl only
- Contrast sleeve around lamp
- Faceted reflector: white only
- T8 3500K lamp
- Ballast
- Universal mounting hardware package
- Daisy chain starter cord, if selected: black vinyl only (order separately)

- 1 Style number
 - 2 Paint color number, if other than black (see options below)
 - 3 Options, if selected (see below)
- ▶ See *Surface Materials*, page B180.

Surface Materials	Options	Price	Required to Specify
-------------------	---------	-------	---------------------

Surface Materials	• Painted light housing other than black	+\$15	Specify paint color number for housing. ▶ See paint color listed in <i>Surface Materials</i> , page B180.
	Bracket Option	• Competitive mounting package • Flush mounting package	No cost No cost

Specification Information					
• Dimensions			• Lamp	• Style	• Base
D	W	H	Wattage	Number	Price

Electronic Ballast

9 1/4"	25"	1 3/4"	17 watts	LSM24K	\$287
9 1/4"	37"	1 3/4"	25 watts	LSM36K	\$308
9 1/4"	49"	1 3/4"	32 watts	LSM48K	\$332

With Chicago Cord Including Circuit Breaker

9 1/4"	25"	1 3/4"	17 watts	LSM24KC	\$334
9 1/4"	37"	1 3/4"	25 watts	LSM36KC	\$355
9 1/4"	49"	1 3/4"	32 watts	LSM48KC	\$379

With Daisy Chain Cords

9 1/4"	25"	1 3/4"	17 watts	LSM24KD	\$311
9 1/4"	37"	1 3/4"	25 watts	LSM36KD	\$332
9 1/4"	49"	1 3/4"	32 watts	LSM48KD	\$356

▶ Specification information continued on next page

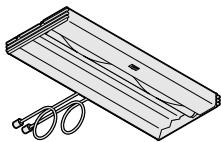
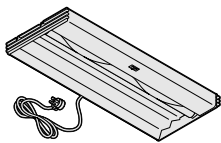

Tip: Remember to order a daisy chain starter cord.
▶ See *Related Products* on next page.

Specification Information

• Dimensions			• Lamp Wattage	• Style Number	• Base Price
D	W	H			

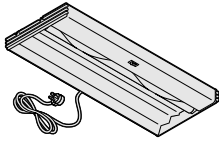

Economizer Electronic Ballast

9 1/4"	25"	1 3/4"	17 watts	LSM24KF	\$326
9 1/4"	37"	1 3/4"	25 watts	LSM36KF	\$347
9 1/4"	49"	1 3/4"	32 watts	LSM48KF	\$371

With Chicago Cord Including Circuit Breaker

9 1/4"	25"	1 3/4"	17 watts	LSM24KFC	\$373
9 1/4"	37"	1 3/4"	25 watts	LSM36KFC	\$394
9 1/4"	49"	1 3/4"	32 watts	LSM48KFC	\$418

With Daisy Chain Cords

9 1/4"	25"	1 3/4"	17 watts	LSM24KFD	\$350
9 1/4"	37"	1 3/4"	25 watts	LSM36KFD	\$371
9 1/4"	49"	1 3/4"	32 watts	LSM48KFD	\$395

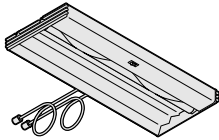

Tip: Remember to order a daisy chain starter cord.
 ▶ See Related Products below.

Related Products

• Quantity in Package	• Length	• Style Number	• Base Price
-----------------------	----------	----------------	--------------

Daisy Chain Starter Cord

1	78"	LS1FSC	\$ 40
6	78"	LS6FSC	\$240

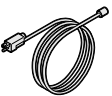

Utility Shelf Lights

SIN 711.1

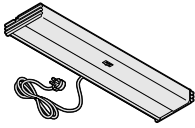

Tip: Daisy chaining is not allowed in New York City or Chicago. Local electrical codes vary, so you should consult a qualified electrical contractor or engineer for proper installation of all electrical equipment.

Tip: Because shelf lights are usually recessed, black is the standard paint color. Paint colors other than black have an upcharge.

Tip: If an optional paint color is selected for the housing, the electrical switches and end caps will remain black plastic.

Standard Includes	Required to Specify
-------------------	---------------------

- Light housing with centered on-off switch: black paint
- End cap cord managers: black plastic only
- Cords:
 - 9' cord with three-prong plug at 45° angle: black vinyl only
 - One 30" and one 48" cord with modular connectors for daisy chaining: black vinyl only
- Prismatic lens
- Angled reflector: white only
- T8 3500K lamp
- Ballast
- Universal mounting hardware package
- Daisy chain starter cord, if selected: black vinyl only (order separately)

- 1 Style number
 - 2 Paint color number, if other than black (see options below)
 - 3 Options, if selected (see below)
- ▶ See *Surface Materials*, page B180.

	Options	Price	Required to Specify
--	---------	-------	---------------------

Surface Materials	• Painted light housing other than black	+ \$15	Specify paint color number for housing. ▶ See paint color listed in <i>Surface Materials</i> , page B180.
Lens	• Bat-wing lens	+ \$22	Specify with <i>bat-wing lens</i> .
Bracket Option	• Competitive mounting package	No cost	Specify with <i>competitive mounting package</i> .
	• Flush mounting package	No cost	Specify with <i>flush mounting package</i> and paint color number for end cap covers.

Specification Information

• Dimensions			• Lamp	• Style	• Base
D	W	H	Wattage	Number	Price

Electronic Ballast

5½"	25"	1¾"	17 watts	LSB24K	\$196
5½"	37"	1¾"	25 watts	LSB36K	\$232
5½"	49"	1¾"	32 watts	LSB48K	\$255

With Chicago Cord Including Circuit Breaker

5½"	25"	1¾"	17 watts	LSB24KC	\$243
5½"	37"	1¾"	25 watts	LSB36KC	\$279
5½"	49"	1¾"	32 watts	LSB48KC	\$302

With Daisy Chain Cords

5½"	25"	1¾"	17 watts	LSB24KD	\$220
5½"	37"	1¾"	25 watts	LSB36KD	\$256
5½"	49"	1¾"	32 watts	LSB48KD	\$279

▶ **Specification information continued on next page**

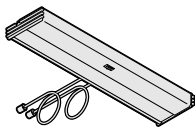
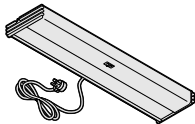

Tip: Remember to order a daisy chain starter cord.
▶ See *Related Products* on next page.

Specification Information

Dimensions			Lamp Wattage	Style Number	Base Price
D	W	H			

Magnetic Normal-Power-Factor Ballast

5 1/2"	19"	1 3/4"	15 watts	LSB18M	\$158
5 1/2"	25"	1 3/4"	17 watts	LSB24M	\$139
5 1/2"	37"	1 3/4"	25 watts	LSB36M	\$175
5 1/2"	49"	1 3/4"	32 watts	LSB48M	\$198

With Chicago Cord Including Circuit Breaker

5 1/2"	19"	1 3/4"	15 watts	LSB18MC	\$205
5 1/2"	25"	1 3/4"	17 watts	LSB24MC	\$186
5 1/2"	37"	1 3/4"	25 watts	LSB36MC	\$222
5 1/2"	49"	1 3/4"	32 watts	LSB48MC	\$245

With Daisy Chain Cords

5 1/2"	19"	1 3/4"	15 watts	LSB18MD	\$182
5 1/2"	25"	1 3/4"	17 watts	LSB24MD	\$163
5 1/2"	37"	1 3/4"	25 watts	LSB36MD	\$199
5 1/2"	49"	1 3/4"	32 watts	LSB48MD	\$222

Related Products

Quantity in Package	Length	Style Number	Base Price
---------------------	--------	--------------	------------

Daisy Chain Starter Cord

1	78"	LS1FSC	\$ 40
6	78"	LS6FSC	\$240

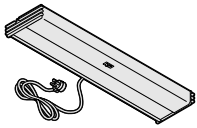

Tip: Magnetic ballasts can cause interference with computer monitors. An electronic ballast is recommended for shelf lights in offices where computers are

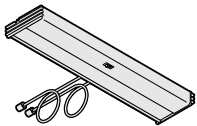

Tip: Remember to order a daisy chain starter cord. See Related Products below.



* Because lamps and ballasts for 19"W shelf lights are more expensive than those for 24"W shelf lights, use 19"W shelf lights only in applications where larger sizes will not fit.

Vertical Wire Manager

SIN 711.1



Tip: Wire manager can be cut in the field to the specific length needed.

Standard Includes	Required to Specify
-------------------	---------------------

- Vertical wire manager: plastic

- 1 Style number
- 2 Plastic color number:
 - 6000 Black
 - 6654 Sand (Vanadium)
 - 6697 Fog
- ▶ See *Surface Materials*, page B180.

Specification Information		
• Height	• Style Number	• Price
48"	TS7PVWM	\$21
•	•	•

• Height	• Style Number	• Price
48"	TS7PVWM	\$21
•	•	•

Surface Materials

Surface Materials	B180
Color Defaults	B182
Directional Laminate Grain Directions	B183
Wood Grain Directions	B184

Surface Materials

This listing includes all the surface material choices that are available for the products in this specification guide.

All fabrics may not be available on junction trim. 78"H trim can accept only Belgrade fabric.

Resources

For more information about surface materials, refer to the following resources:

Additional surface materials specification tools are available to assist you in the specification process—the Surface Materials Binders and the Surface Materials Tool Box.

Surface Materials

Binders include:

- Surface Materials Reference Manual
- A complete set of swatch cards for hard surfaces, vertical surface fabrics, and seating upholstery

Surface Materials

Tool Box (S8150) provides 3" x 3" samples of the following surface materials:

- Vertical surface fabrics
- Seating upholstery
- Wood veneer
- Paint
- Laminate

Paint

Applies to:

- Panel components
- Worksurfaces
- Storage components
- Lighting

Price Group 1

Textured Paint

- 7207 Black
- 7225 Sand (Vanadium)
- 7236 Fog
- 7237 Slate
- 7238 Fieldstone
- 7239 Midnight

Price Group 2

Metallic Paint

- 4750 Champagne
- 4751 Bronze
- 4752 Steel
- 4788 Gold Dust
- 4798 Sterling
- 4799 Platinum

Price Group 3

Accent Paint

Please see the Accent Paint swatchcard in the *Surface Materials Finishes Binder* for a complete list of these colorful paints.

Tip: Price Group 3 paint is not available on 24"D and 30"D pedestals or 22"D mobile pedestals.

PerfectMatch II Paint

PerfectMatch II paint is a service that allows you to create your own paint color. Refer to the *Surface Materials Reference Manual* for more information about this program.

Tip: The PerfectMatch II paint program is not available on 24"D and 30"D pedestals or 22"D mobile pedestals.

Laminate

Laminate Color Choices

Standard Laminate

- 2412 Natural Cherry
- 2422 Medium Cherry
- 2511 Winter on Maple
- 2592 Blonde on Maple
- 2632 Medium Oak
- 2714 Natural Walnut
- 2722 Cream
- 2729 White Sand
- 2730 Arctic White
- 2746 Black
- 2759 Warm White
- 2772 Medium Mahogany on Walnut

- 2810 Dawn
- 2811 Mist
- 2820 Coffee Speckle
- 2822 Woodrose Speckle
- 2823 Driftwood Speckle
- 2824 Smoke Speckle
- 2825 Vanadium Speckle
- 2850 Vanadium Fiber
- 2851 Rhyme Fiber
- 2852 Tungsten Fiber
- 2854 Vellum Fiber
- 2857 Stream Fiber
- 2859 Novell Fiber
- 2860 Granite Fiber
- 2870 Blonde Bronze Patina
- 2871 Blackened Bronze Patina
- 2872 Silver Plate Patina
- 2873 Instant Iron Patina

Accent Laminate

Accent laminates are available with an upcharge of \$60 U.S. per worksurface. Please see the *Accent Laminate* swatch card within the *Steelcase Hard Finishes Binder* for a complete listing of these colorful laminates.

For additional information, refer to the *Steelcase Surface Materials Reference Manual*.

Open Line Laminate

This service allows you to order non-standard laminate at an additional processing fee of \$60 per worksurface, plus the cost of the laminate.

Edge color for the Open Line laminate must be determined by the dealer and customer before orders can be entered.

For additional information, refer to the *Steelcase Surface Materials Reference Manual*.

Wood

Steelcase carefully selects veneer and solid wood or consistent color and grain structure. Wood is a natural material and variations will occur in color, grain, and texture. These variations are part of the inherent natural beauty of wood and are not considered defects.

All wood products will darken with age and exposure to ultraviolet light. This is especially apparent with cherry and maple veneer. We recommend that desk accessories be arranged periodically to ensure even aging of wood surfaces.

Veneers are flat cut and are matched for proper balance and consistency.

Open-pore finish is a medium-gloss finish that leaves the wood texture visible to the eye and distinguishable to the touch.

Open-pore finish choices

- 3412 Natural Cherry
- 3422 Medium Cherry
- 3562 Linseed on Maple
- 3572 Amber Maple on Maple
- 3582 Winter on Maple
- 3592 Blonde on Maple
- 3632 Medium Oak
- 3642 Natural Oak
- 3712 Natural Walnut
- 3722 Dark Mahogany on Walnut
- 3742 Autumn Walnut
- 3772 Medium Mahogany on Walnut
- 3792 Black Walnut

Full-fill finish is a medium-gloss finish that completely fills the grain texture, yet allows the grain pattern to be seen. The wood has a lustrous, satiny look and it is smooth to the touch. This finish is available on the wood worksurface or top only.

Full-fill finish choices

- 3414 Natural Cherry
- 3424 Medium Cherry
- 3534 Winter on Maple
- 3544 Blonde on Maple
- 3564 Linseed on Maple
- 3574 Amber on Maple
- 3634 Medium Oak
- 3644 Natural Oak
- 3714 Natural Walnut
- 3724 Dark Mahogany on Walnut
- 3744 Autumn Walnut
- 3774 Medium Mahogany on Walnut
- 3794 Black Walnut

Customiz stain

Customiz stain is a service that allows you to create your own stain colors on standard veneers. Customiz stain color is available on all product lines that offer wood veneer.

A one-time formulation fee of \$400 per color, per customer processing fee will apply. The fee covers the cost of formulating the Customiz finish and applies regardless of whether or not an order for product is placed. Please refer to the "Customiz Stain" option price column in your specification guide for the unit upcharge.

Customiz stain takes 10 days to formulate. Consult the *Surface Materials Reference Manual* for more information. Custom veneers are also available and must be quoted by specials engineering. Customiz stain on custom veneers take two to four weeks to formulate.

Requirements and information on ordering a Customiz stain color are found in the *Surface Materials Reference Manual*.

Plastic

6000 Black
6654 Sand (Vanadium)
6685 Champagne
6686 Gold Dust
6687 Bronze
6688 Steel
6694 Slate
6695 Midnight
6696 Sterling
6697 Fog
6698 Fieldstone
6699 Platinum

Applies to:

- Oval pull

6000 Black
6654 Sand (Vanadium)
6694 Slate
6695 Midnight
6697 Fog
6698 Fieldstone

Note: The following two plastics are available for existing customers only. The matching paints have moved to the *Transitional Specification Guide*:
6651 Tungsten
6652 Titanium

Metal

Applies to:

- Handle pull

0835 Black
9211 Nickel

Applies to:

- Contemporary pull

9201 Polished Chrome
9212 Silver

Vertical Surface Fabric

For flammability ratings, see *Flammability Ratings for Steelcase Panel Systems*, page A16.

Classics Collection

Surface materials in the Classics Collection are timeless. These materials should be available for a minimum of 10 years from the date the material is introduced into the Classics Collection. The Classics Collection includes the following fabrics in Price Groups 1 through 3:

Price Group 1

Abacus*
Acadia*
Bariolage
Belgrade
BellaRose*
Boccie**
Cornice*
Embrasure*
*Not available on 80"H panels
**Not available on panels taller than 68"H

Additional fabrics are available in this price group. Call Designtex at 1.800.221.1540 for further information about the Graded-In Program

Price Group 2

Amiranté
Ashanti
Ashanti Reverse
Bouquet*
Cordial
Firenze
Firenze Reverse
Fresco
Milano
Racquets**
Regatta
Wilshire
*Not available on 80"H panels
**Not available on panels taller than 68"H

Additional fabrics are available in this price group. Call Designtex at 1.800.221.1540 for further information about the Graded-In Program
▶ See *Surface Materials Reference Manual* for a listing of available fabric colors.

Price Group 3

Martinique

Designtex Graded-In Program

All Designtex Graded-In fabrics are now supported just like standard fabrics when ordered on Steelcase furniture. The Designtex Graded-In Program also includes the Environmental Impact Collection, which offers sustainable textiles in affordable price groups. For additional information and fabric samples, contact your local Designtex sales representative at 1.800.221.1540.

Designtex fabrics are graded into Steelcase Price Groups 1 through 3:

Price Group 1

Moors (Environmental Impact Collection)

Price Group 2

About Face
Acres
Bracken (Environmental Impact Collection)
Brunswick
Cut to the Chase
Gimlet
Niche
Senecal
Solitaire
Streams (Environmental Impact Collection)

Price Group 3

Apex
Dalmatian
Foxtrot
Lotto
Meringue
No Deposit No Return
Pick-Up Sticks
Rain (Environmental Impact Collection)
Sea Breeze (Environmental Impact Collection)
Six Pack
Sumo
That Straw Stuff
▶ See *Surface Materials Reference Manual* for a listing of available fabric colors.

Price Group COM (Customer's Own Material)**Fabric Approval and Yardage**

To confirm whether a particular COM material has already been tested for use on a specific Steelcase product or to determine actual yardage requirements:

- Visit www.steelcase.com
- Click on "Knowledge & Design"
- Select "Customer's Own Material"

You can find the same information on the in2 site. Follow these steps:

- Visit www.in2.steelcase.com
- Click on "Sales/Design Team"
- Select "Surface Materials"
- Select "Customer's Own Material"

For additional information regarding Customer's Own Material, call 1.888.STEELCASE.

Transitional

▶ See the *Transitional Specification Guide* for a list of transitional surface materials.

Color Defaults

Edges

The color of the edges of a worksurface is determined by the laminate color you specify and therefore cannot be specified.

Laminate Color		3 mm Front Edge Color		1 mm Back and Side Edge Color	
2412	Natural Cherry	2793	Coffee	2412	Natural Cherry
2422	Medium Cherry	2793	Coffee	2422	Medium Cherry
2511	Winter on Maple	2759	Warm White	2511	Natural Maple
2592	Blonde on Maple	2759	Warm White	2592	Blonde on Maple
2632	Medium Oak	2793	Coffee	2632	Medium Oak
2714	Natural Walnut	2714	Natural Walnut	2714	Natural Walnut
2722	Cream	2722	Cream	2722	Cream
2729	White Sand	2848	Sand	2848	Sand
2730	Arctic White	2776	Fog	2776	Fog
2746	Black	2792	Black	2792	Black
2759	Warm White	2759	Warm White	2759	Warm White
2772	Medium Mahogany on Walnut	2772	Medium Mahogany on Walnut	2772	Medium Mahogany on Walnut
2810	Dawn	2794	Dawn	2794	Dawn
2811	Mist	2798	Mist	2798	Mist
2820	Coffee Speckle	2722	Cream	2722	Cream
2822	Woodrose Speckle	2794	Dawn	2794	Dawn
2823	Driftwood Speckle	2722	Cream	2722	Cream
2824	Smoke Speckle	2798	Mist	2798	Mist
2825	Vanadium Speckle	2720	Ice	2720	Ice
2850	Vanadium Fiber	2848	Vanadium	2848	Vanadium
2851	Rhyme Fiber	2722	Cream	2722	Cream
2852	Tungsten Fiber	2798	Mist	2798	Mist
2854	Vellum Fiber	2759	Warm White	2759	Warm White
2857	Stream Fiber	2798	Mist	2798	Mist
2859	Novell Fiber	2793	Coffee	2793	Coffee
2860	Granite Fiber	2792	Black	2792	Black
2870	Blonde Bronze Patina	2848	Vanadium	2848	Vanadium
2871	Blackened Bronze Patina	2785	Grey V5	2785	Grey V5
2872	Silver Plate Patina	2720	Ice	2720	Ice
2873	Instant Iron Patina	2785	Grey V5	2785	Grey V5

Directional Laminate Grain Directions

Directional laminates
are standard with the grain
directions shown.

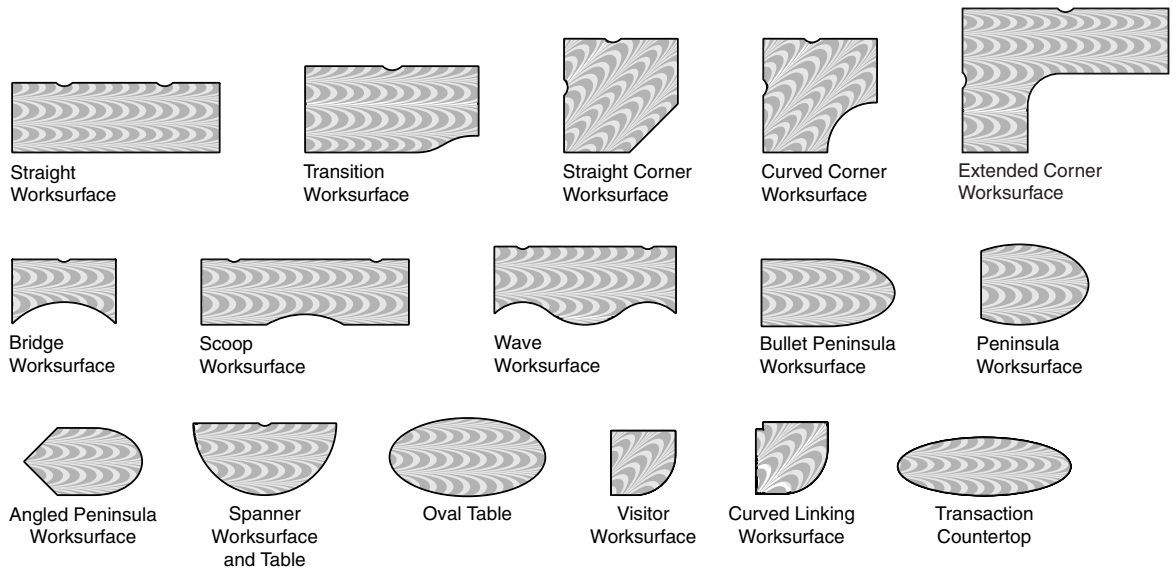

Make a sketch of the
grain direction on adjacent
worksurfaces to be sure
they are suitable for your
installation.

Examples:

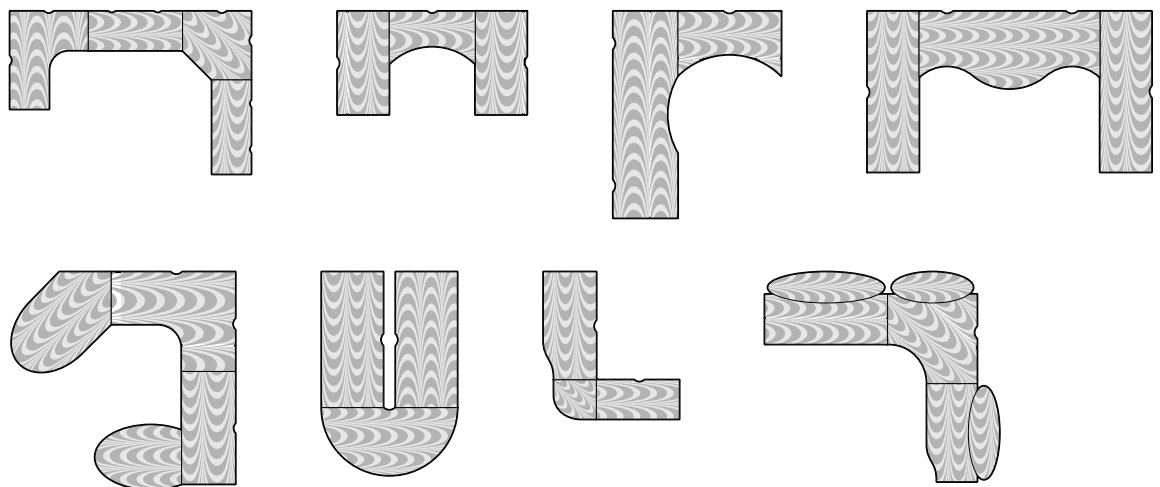

Wood Grain Directions

The appearance of wood veneer may change slightly depending on the angle from which it is viewed. This natural phenomenon is called polarization, and it can be seen on natural veneer. Polarization is often noticed on worksurfaces installed at a 90-degree angle with each other. Please refer to the following illustrations for an understanding of grain direction on your installation.

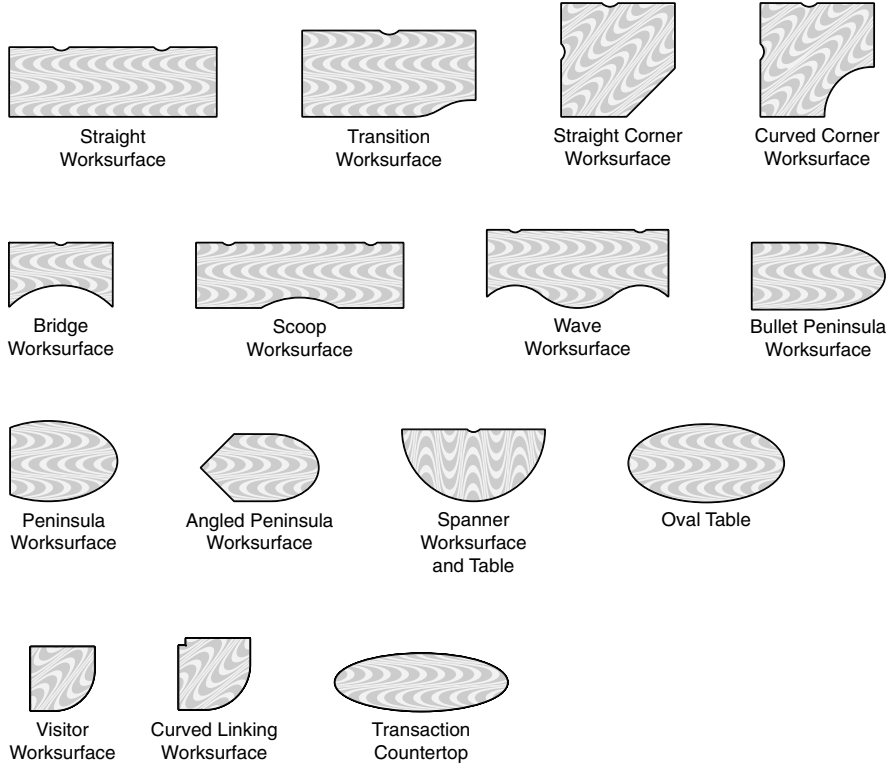

Resources

Resources

Answer

Lock and Keying

B186

Lock and Keying

All locking products are standard with factory-installed, keyed-random locks. Consecutive, specific, and random keying are available as field-installed options.

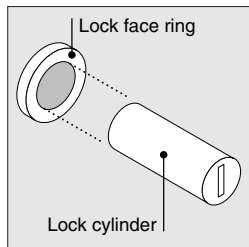

Locks consist of a factory- or field-installed lock cylinder and a factory-installed lock face ring.

Two types of locks are available—the standard keying system (FR series) and the master keying system (XF series). All the locks in the XF series can be opened with a single master key.

Factory-Installed Keying

Factory-installed locks are always key random (standard) or master key random (option). Key random means that the locks will be assigned arbitrarily at the factory with key numbers ranging from FR305 to FR454 (Master keying numbers: XF1001 to XF1150). All locks within a unit will be keyed alike.

Tip: Random keying can mean that different furniture

units will have the same key number. If you must have all locks keyed differently, you should specify field-installed, key specific or key consecutive lock cylinders.

▶ See below.

Key Random

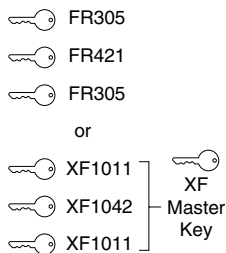

Required to Specify

Master key random	+\$20	Specify with master key random.
--------------------------	-------	---------------------------------

Field-Installed Keying

Field-installed locks are only available on products that include factory-installed lock mechanisms.

Specify "plug" when specifying furniture, and the product will ship with a plastic plug in place of the lock cylinder.

Front-removable lock cylinders must be specified separately. You must also order a special lock tool to install or remove lock cylinders in the field.

Tip: Lock tools are reusable. You do not need to order additional lock tools with every furniture order.

Lock cylinders will be shipped separately so that you can install the locks when you are ready.

Three keying choices are available for field installation—random (standard), specific, and consecutive. All three are also available with master keying, which means that all locks can be opened with a single master key.

Key random means that the locks will be assigned arbitrarily at the factory with key numbers ranging from FR305 to FR454 (Master keying numbers: XF1001 to XF1150).

Tip: Random keying can mean that different furniture units will have the same key number. If you must have all locks keyed differently, you should specify key specific or key consecutive lock cylinders.

Key specific means that you can specify any key number from FR305 to FR454 (Master keying numbers: XF1001 to XF1150). This option can be used to key all the furniture units in a workstation or department the same.

Tip: Designate the quantity per key number in your specification.

▶ See example at right.

Key consecutive means that you can specify lock numbers in a consecutive order to ensure that no two locks have the same key number until the key sequence repeats. You must select a beginning key number from FR305 to FR454 (Master keying numbers: XF1001 to XF1150).

Example of a typical lock cylinder specification is shown below:

10	LOCK9201FR FR320
5	LOCK9201FR FR350
15	LOCK9201XF XF1100
30	Total
1	877102003SR standard lock tool
1	877102002SR master lock tool

Key Random

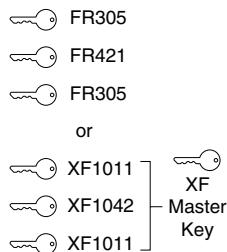

Key Specific

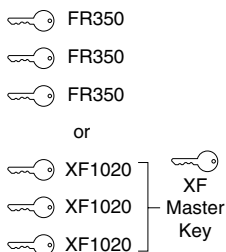

Key Consecutive

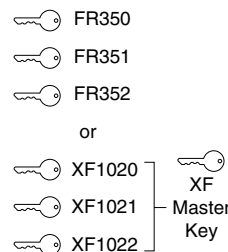

Field-Installed Lock Cylinders

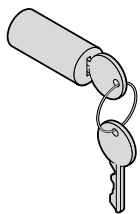

Tip: Lock price is included in price of furniture with locks.

Tip: For replacement lock cylinders, refer to Service Parts.

Standard Includes		Required to Specify
<ul style="list-style-type: none"> Lock cylinder: 9201 Polished Chrome or 9250 Ember Chrome Two keys 		1 Style number 2 Options, if selected (see below)

Options	Price	Required to Specify
Key specific	No cost	Select key number from FR305–FR454.
Key consecutive	No cost	Specify <i>key consecutive</i> and select beginning key number from FR305–FR454.
Master key random	+\$20 each	Specify <i>master key random</i> .
Master key specific	+\$20 each	Specify key number from XF1001–XF1150.
Master key consecutive	+\$20 each	Specify <i>master key consecutive</i> and select beginning key number from XF1001–XF1150.

Specification Information

Color	Style Number	Base Price

FR Series (Standard Keying System) – Lock Cylinder

Polished Chrome	LOCK9201FR	No cost
Ember Chrome	LOCK9250FR	No cost

Standard Lock Tool

	877102003SR	\$16
--	--------------------	------

XF Series (Master Keying System) – Lock Cylinder

Polished Chrome	LOCK9201XF	No additional cost. Price included in price of furniture with master-keyed locks.
Ember Chrome	LOCK9250XF	No additional cost. Price included in price of furniture with master-keyed locks.

Master Lock Tool

	877102002SR	\$16
--	--------------------	------

Tip: You can change lock cylinders in the field by using the appropriate lock tool.



Montage

► For more detailed product information, see the *Montage Solutions Specification Guide* or consult your Steelcase dealer.



Statement of Line **C2**



Specifying Tips

Specifying	C35
Frames, Doors, and Junctions (SIN 711.1)	C41
Frame Wiring and Cabling (SIN 711.1)	C69
Tiles (SIN 711.1)	C109
Worksurfaces (SIN 711.1)	C123
Storage (SIN 711.1)	C147
Wood Selections (SIN 711.1)	C165
Lighting (SIN 711.1)	C237

Surface Materials **C251**

Resources **C261**

Montage

Statement of Line

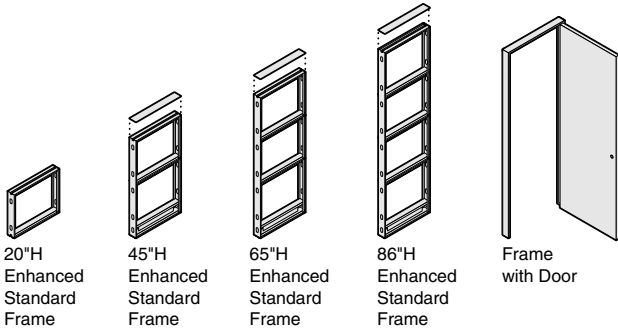

Specifying
▶ Pages C42-C45

Enhanced Standard Frames

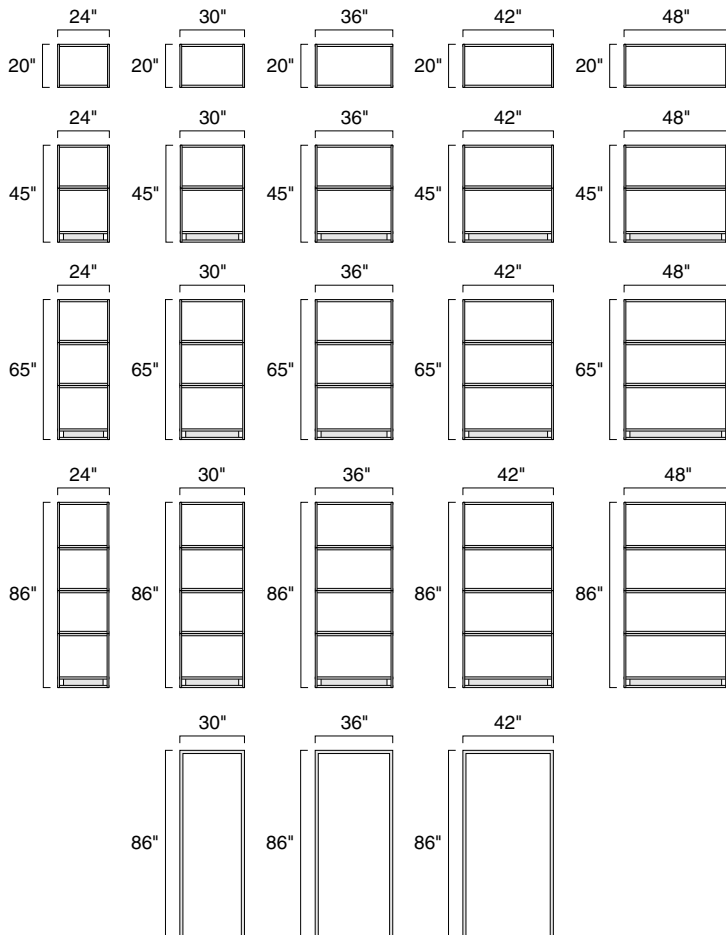

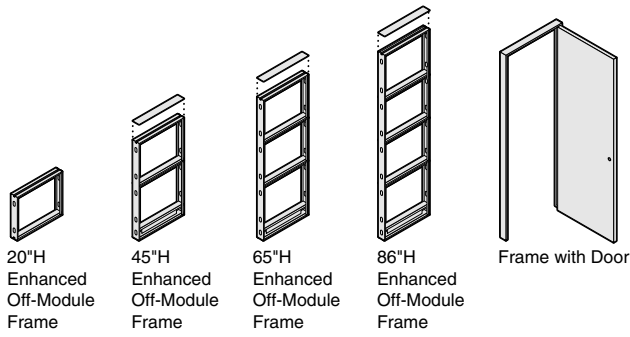

Specifying
▶ Pages C46–C52

Enhanced Off-Module Frames

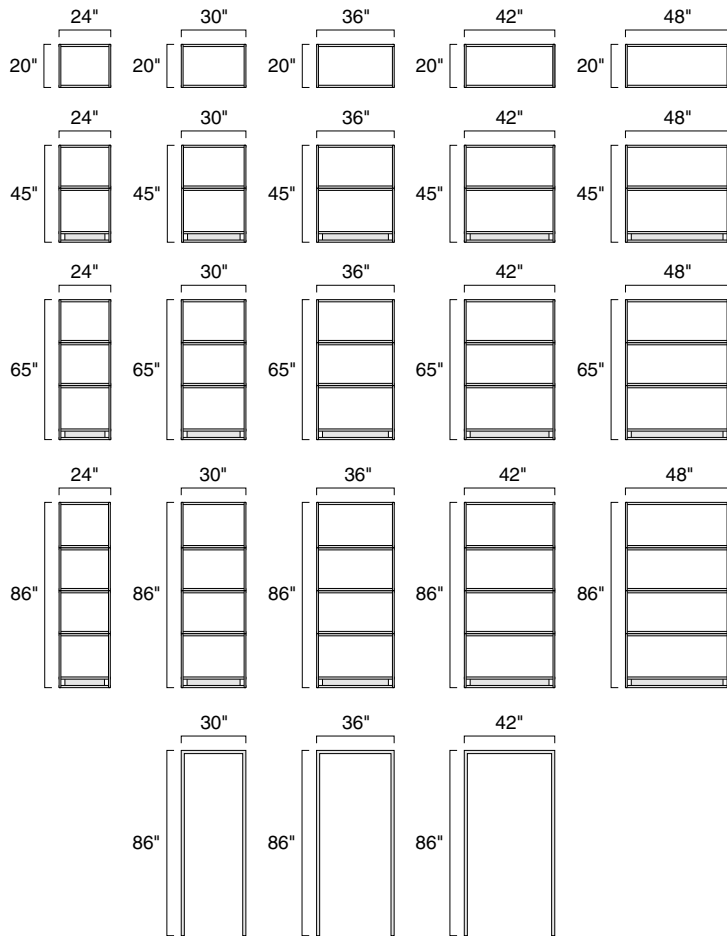

Junctions

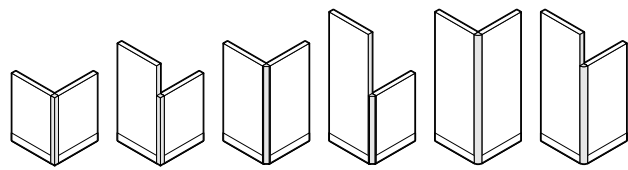

L-Junctions

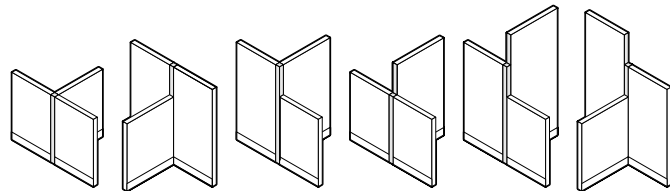

T-Junctions

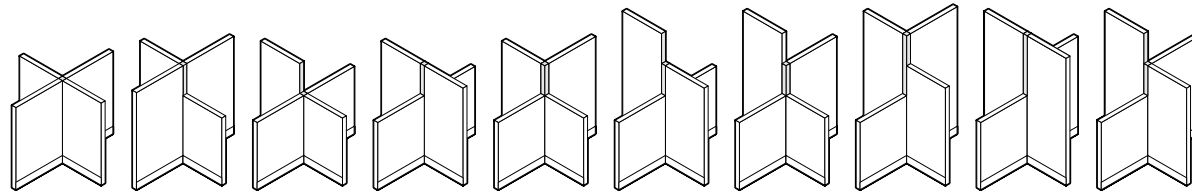

X-Junctions

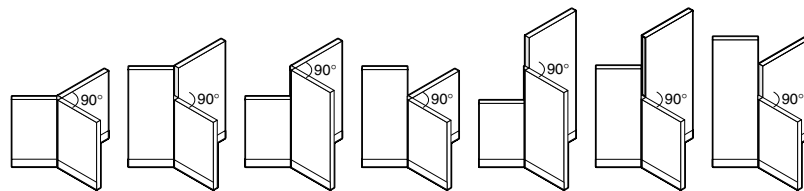

Y-Junctions

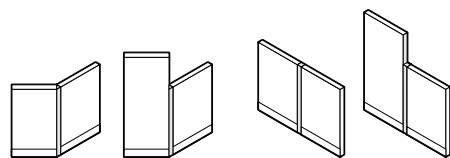

V-Junctions

I-Junctions

Tip: Combinations of frames that exceed 86"H require special junction kits. Contact your Steelcase area office for details about special applications.

Frame Junction Kits for Use with Frames with Lay-In Cable Track

Tip: Combinations of frames that exceed 86"H require special junction kits. Contact your Steelcase area office for details about special applications.

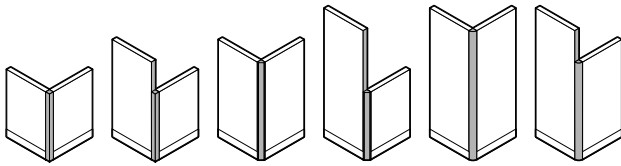

L-Junctions

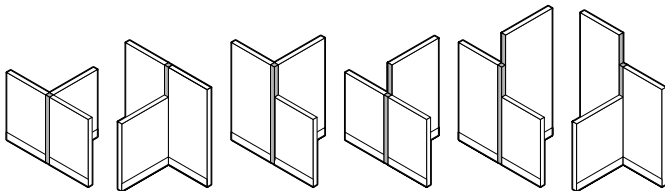

T-Junctions

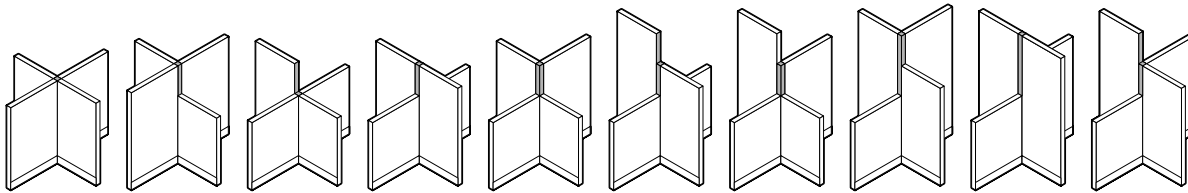

X-Junctions

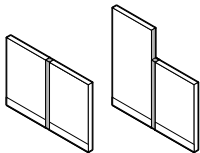

I-Junctions

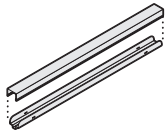

Specifying
▶ Page C86

Lay-In Cable Track and Cover

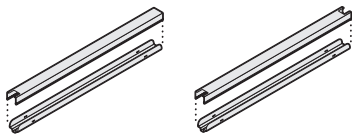
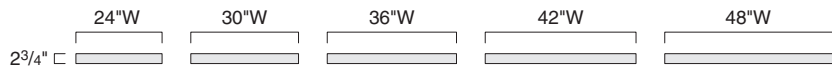

Specifying
▶ Page C87

Lay-In Cable Track and Cover with Change-of-Height Cutout

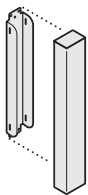
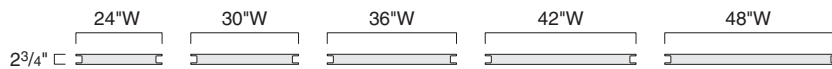
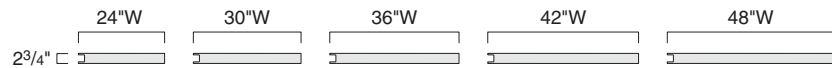

Specifying
▶ Page C87

Lay-In Cable Track and Cover for Change-of-Height

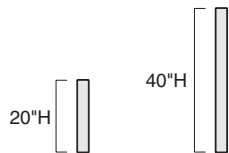

End Trim for Use with Frames with a Lay-In Cable Track

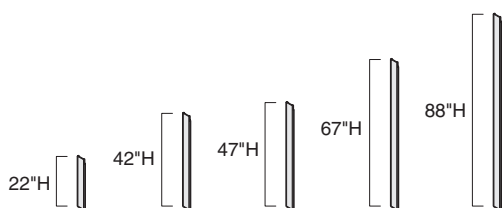

Tip: End trim is 2" taller than frame and/or stacker frame on which it is mounted.

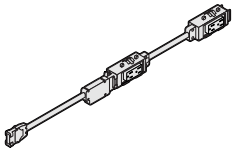

Powerkits
Specifying
▶ Page C70

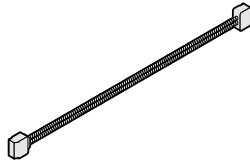

Pass-Through Powerkits
Specifying
▶ Page C71

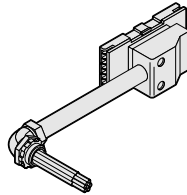

Power Infeeds
Specifying
▶ Page C72

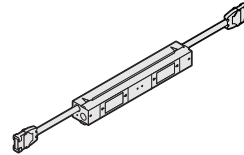

Power Infeeds for Use in New York City
Specifying
▶ Page C73

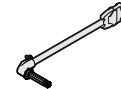

Power Harnesses for Use with Power and Cable Pole
Specifying
▶ Page C74



Power and Cable Poles
Specifying
▶ Page C74

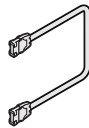

Modular Harnesses for Base-to-Desk Height Power Transfer and Off-Module Desk-Height Power Transfer Cable
Specifying
▶ Page C75

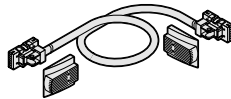

Powerkit External Off-Module Spine-to-Fin Modular Jumpers
Specifying
▶ Page C75



Chicago Junction Boxes
Specifying
▶ Page C76

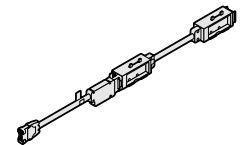

Retrofit Powerkits
Specifying
▶ Page C76

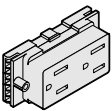

15-Amp or 20-Amp Receptacles
Specifying
▶ Pages C78–C79

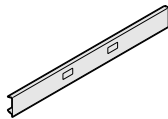

Powerkit Base Covers
Specifying
▶ Page C80

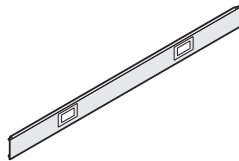

Powerkit Base Covers for Use with Off-Module Jumper Cable
Specifying
▶ Page C80

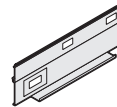

Powerkit Enhanced Desk-Height Cavity Covers
Specifying
▶ Page C82



Cable Carrier
Specifying
▶ Page C82

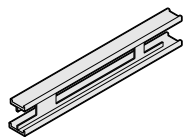

Desk-Height Cavities
Specifying
▶ Page C83

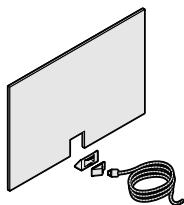

Enhanced Non-Tackable Tiles with Cutout and Base Fiber-In
Specifying
▶ Page C83

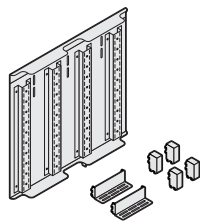

Consolidation Point Kit
Specifying
▶ Page C84



Cable and Fiber Reels
Specifying
▶ Page C143



Termination Plate
Specifying
▶ Page C143

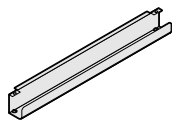

Cable Storage Tray
Specifying
▶ Page C146

Montage Statement of Line, continued

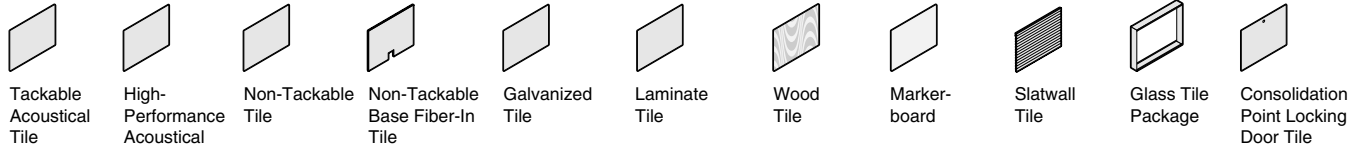

Enhanced Tiles

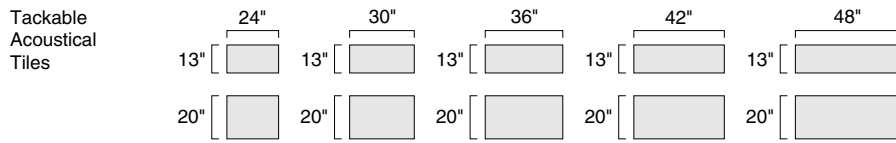

Tip: Enhanced tiles will work with both standard frames and enhanced frames manufactured after June 11, 2001.

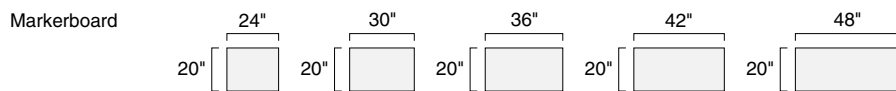
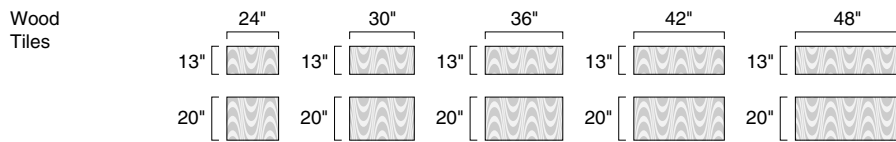
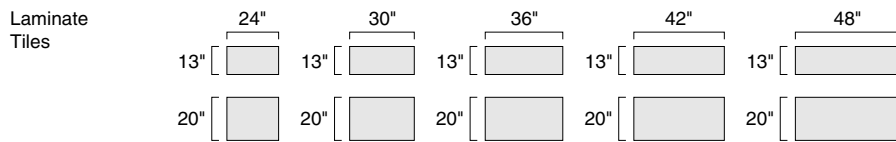
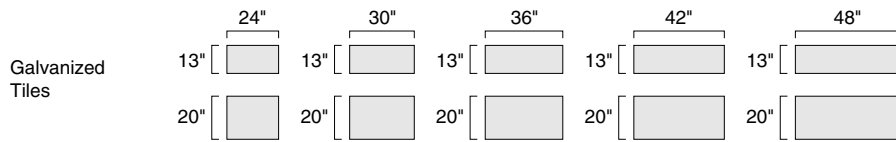
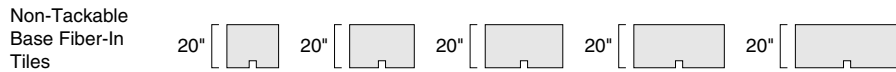
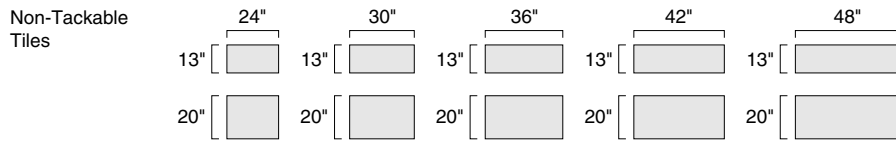
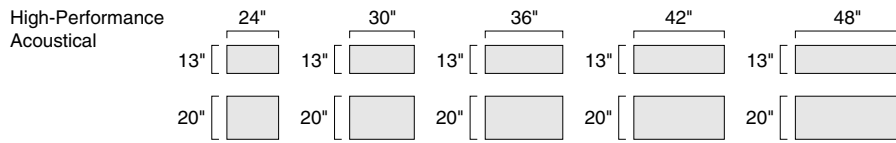

Tile dimensions are nominal.

Slatwall
Tiles

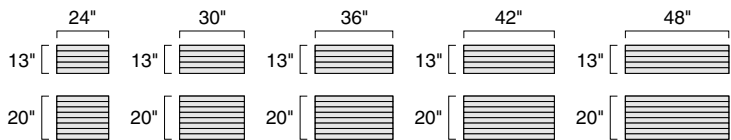

Glass Tile
Packages

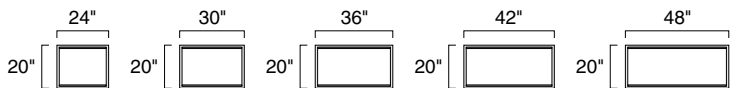

Consolidation
Point Locking
Door Tiles



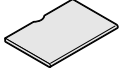

Specifying
▶ Page C124

Straight Worksurfaces

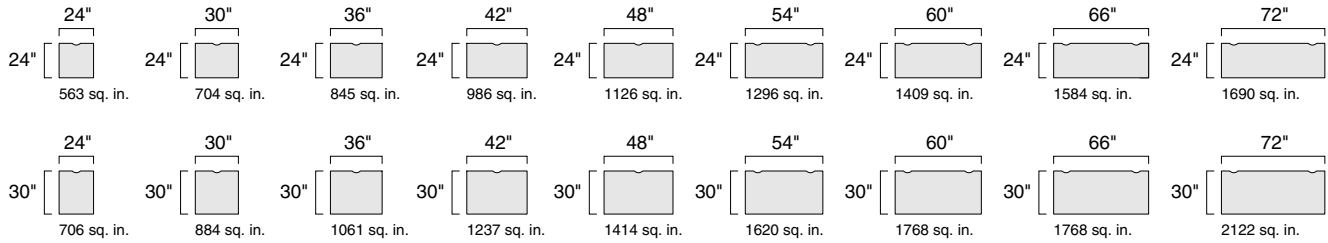

Specifying
▶ Page C125

Corner Worksurfaces*

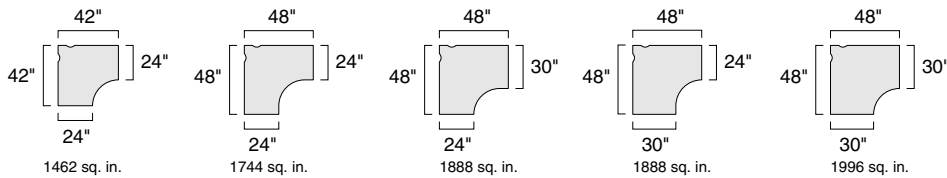

* Drawings and dimensions show left-hand units. Right-hand units are also available.

Dimensions are nominal for planning purposes, however actual dimensions of work-surface depths are 23 1/2" and 29 1/2". This 1/2" gap at the back of the work-surface allows space for cable drops. Square-inch measurements are exact.



Specifying
▶ Pages C126–C127

Montage

Extended Corner Worksurfaces*

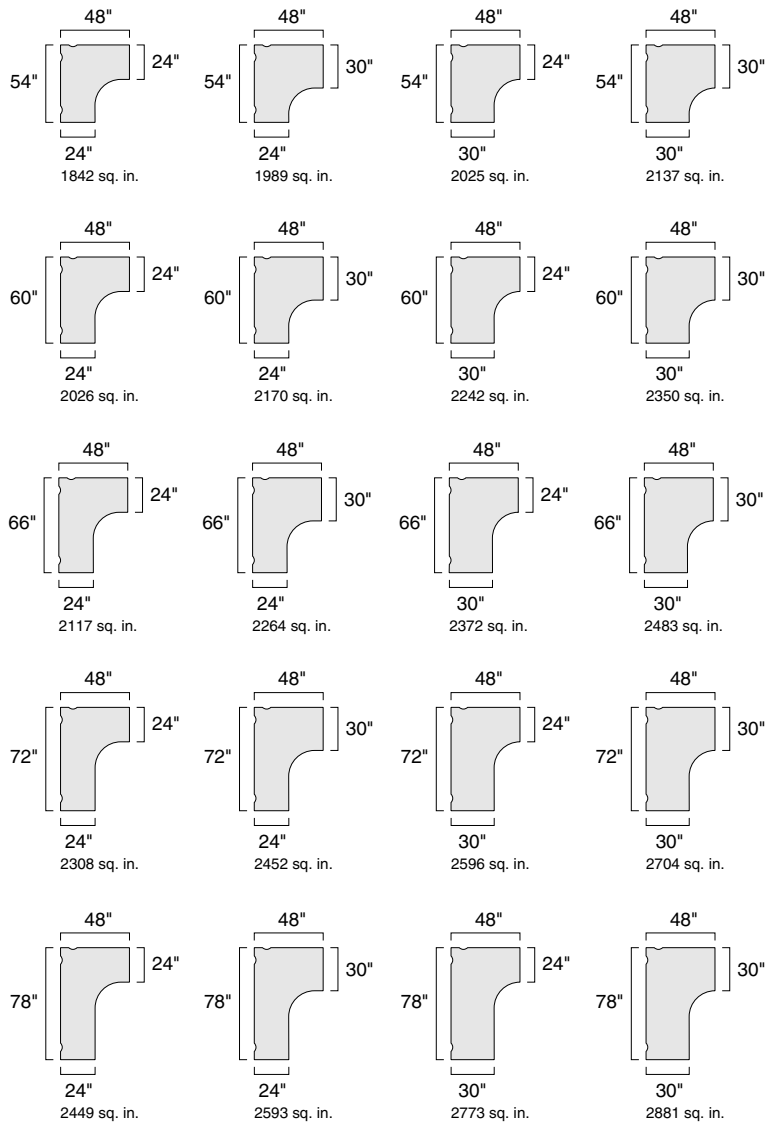

* Drawings and dimensions show left-hand units. Right-hand units are also available.

Dimensions are nominal for planning purposes, however actual dimensions of work-surface depths are 23¹/₂" and 29¹/₂". This 1/2" gap at the back of the work-surface allows space for cable drops. Square-inch measurements are exact.

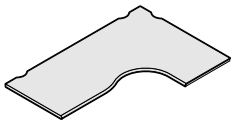

Specifying
▶ Page C128

Extended Corner Cove Worksurfaces*

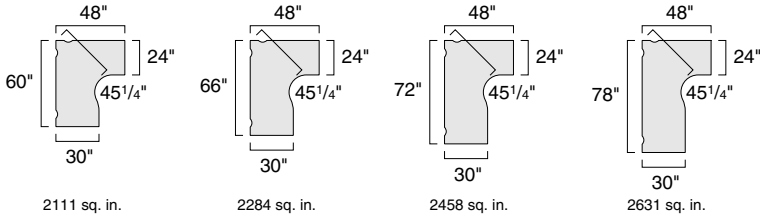

Specifying
▶ Page C129

Bubble Visitor Worksurfaces*

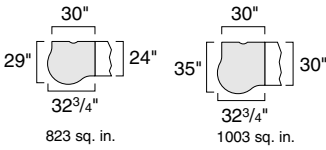

Specifying
▶ Page C130

Jetty Worksurfaces*

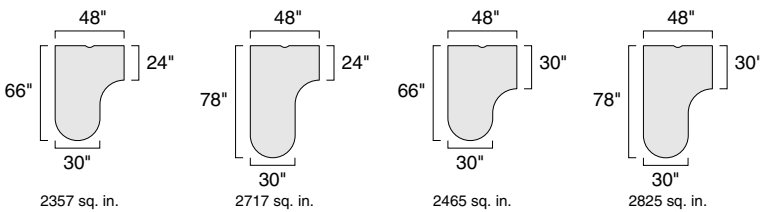

* Drawings and dimensions show left-hand units. Right-hand units are also available.

Dimensions are nominal for planning purposes, however actual dimensions of worksurface depths are 23 1/2" and 29 1/2". This 1/2" gap at the back of the worksurface allows space for cable drops. Square-inch measurements are exact.



Specifying
▶ Page C131

Bubble Jetty Worksurfaces*

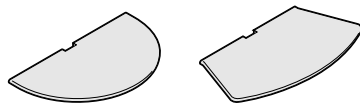
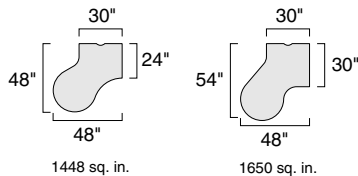

Specifying
▶ Page C132

Spanner and Fanned Spanner Worksurfaces

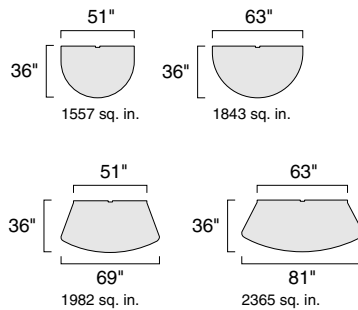

* Drawings and dimensions show left-hand units. Right-hand units are also available.

Dimensions are nominal for planning purposes, however actual dimensions of work-surface depths are 23¹/₂" and 29¹/₂". This ¹/₂" gap at the back of the worksurface allows space for cable drops. Square-inch measurements are exact.

Adjustable-Height Worksurfaces

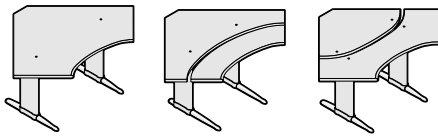

Specifying
▶ Page C140

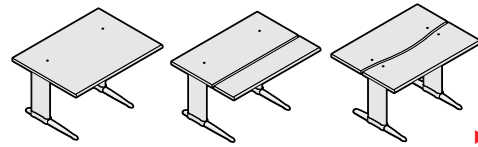

Specifying
▶ Page C140

Corner, with Crank

	39¼"W	40"W	45¼"W	46"W
22¼"D	S,D	B	S,D	B

B = Bi-level worksurface
D = Dual worksurface
S = Single worksurface

Straight, with Crank

	40"W	46"W
34¼"D	S,D,B	S,D,B

B = Bi-level worksurface
D = Dual worksurface
S = Single worksurface

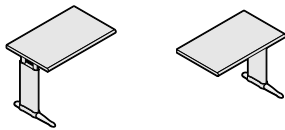

Specifying
▶ Page C141

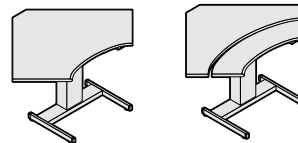

Specifying
▶ Page C142

Extension, Crank Adjustable

	39¼"W	45¼"W
22¼"D	L,R	L,R

L = Left-hand worksurface
R = Right-hand worksurface

Corner, Electrically Adjustable

	39¼"W	45¼"W
22¼"D	S,D	S,D

D = Dual worksurface
S = Single worksurface

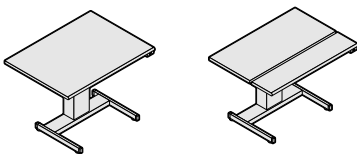

Specifying
▶ Page C142

Straight, Electrically Adjustable

	40"W	46"W
34¼"D	S,D	S,D

D = Dual worksurface
S = Single worksurface

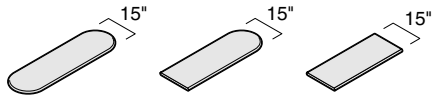

Specifying
▶ Page C133

Straight Countertops

	24"W*	30"W*	36"W*	42"W*	48"W*	54"W	60"W	66"W	72"W	78"W	84"W	90"W	96"W
Both ends curved	●	●	●	●	●	●	●	●	●	●	●	●	●
One end curved	●	●	●	●	●	●	●	●	●	●	●	●	●
Both ends straight	●	●	●	●	●	●	●	●	●	●	●	●	●

* Width of corresponding frame.

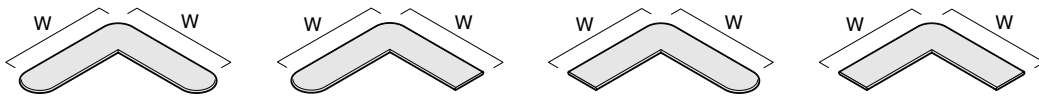

Specifying
▶ Pages C134–C135

Corner Countertops

	24"W*	30"W*	36"W*	42"W*	48"W*
24"W*	●	●	●	●	●
30"W*	●	●	●	●	●
36"W*	●	●	●	●	●
42"W*	●	●	●	●	●
48"W*	●	●	●	●	●

* Width of corresponding frame.

Montage Statement of Line, continued

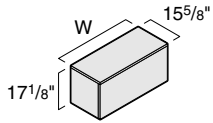

Specifying
▶ Pages C148–C150

Universal Overhead Bins

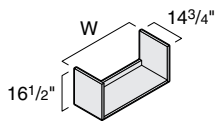
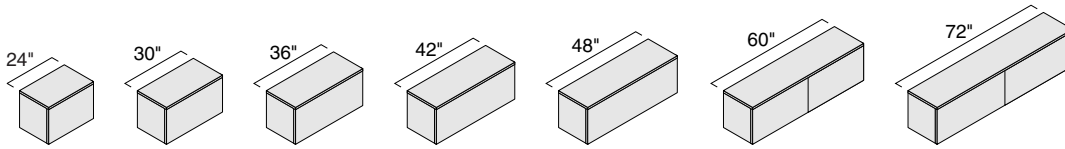

Specifying
▶ Page C151

Universal Full-Height Shelves

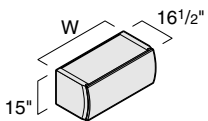
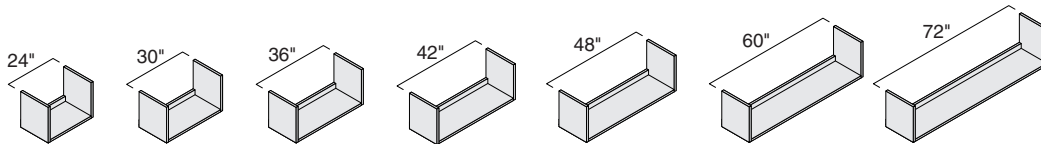

Specifying
▶ Pages C157–C158

Universal Curved Front Bins

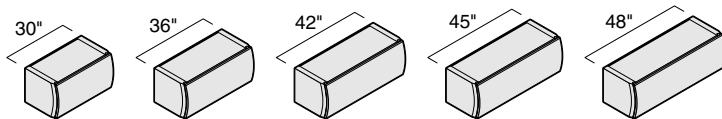

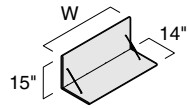

Specifying
▶ Page C159

Universal L-Shelves

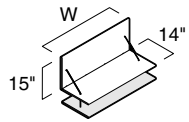
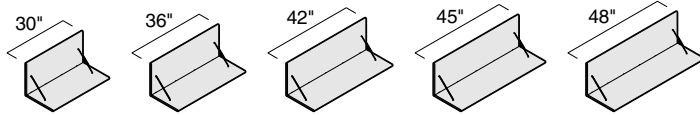

Specifying
▶ Page C161

Stationary Shelves

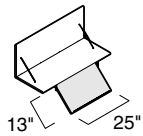
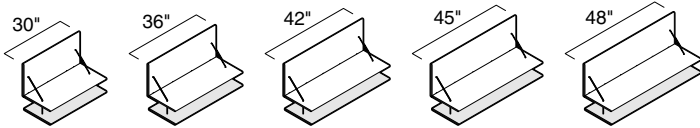

Specifying
▶ Page C161

Display Shelf



Montage Statement of Line, continued

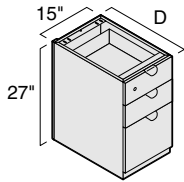

Specifying
▶ Pages C163–C164

Fixed Pedestals

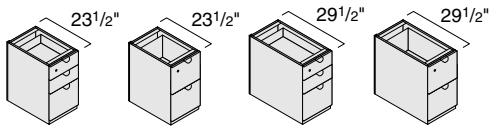

Tip: Context pedestals, lateral files, and mobile pedestals have visual details that match the Montage pedestals.

▶ See the *Context Specification Guide*.

Montage Wood Selections

Statement of Line

Montage Wood Selections
Statement of Line

Worksurfaces



Specifying
▶ Page C166

Straight Worksurfaces

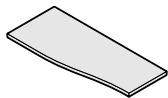
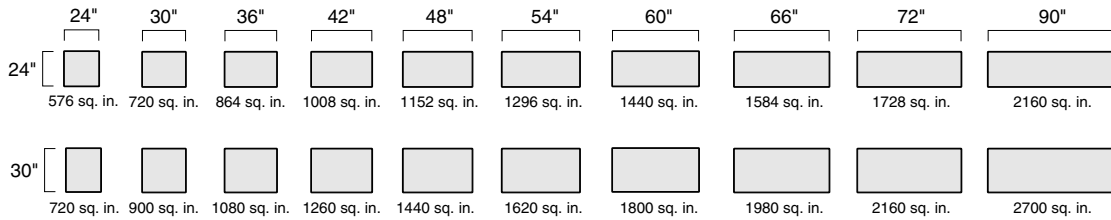

Left-hand Unit

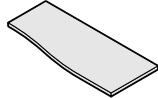

Right-hand Unit

Specifying
▶ Page C168

Transition Worksurfaces*

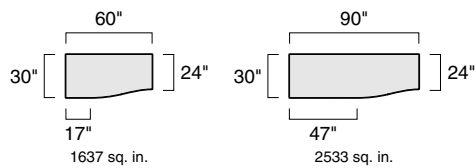

* Left-hand units shown.
Right-hand units available.

Actual dimensions of Wood Selections top depths are 24" and 30" as shown. Unlike Torus Edge tops, these Wood Selections tops do not provide a 1/2" gap between the back edge of the worksurface and the tiles. Square-inch measurements are exact.

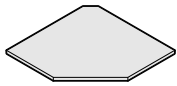

Specifying
▶ Page C170

Corner Worksurfaces

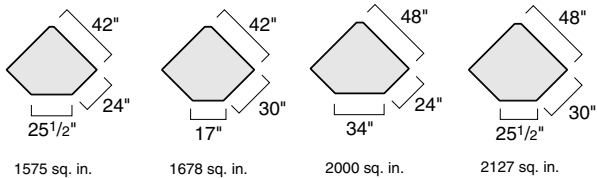

Specifying
▶ Page C171

Cornerstone Worksurfaces*

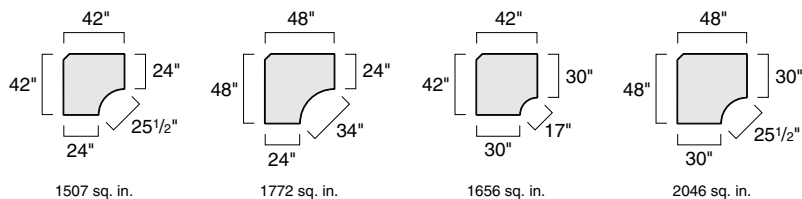

* Left-hand units shown.
Right-hand units available.

Actual dimensions of Wood Selections top depths are 24" and 30" as shown. Unlike Torus Edge tops, these Wood Selections tops do not provide a 1/2" gap between the back edge of the worksurface and the tiles. Square-inch measurements are exact.

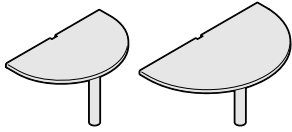

Specifying
▶ Page C172

Spanner Worksurfaces

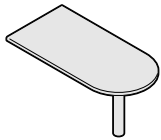
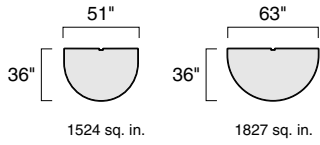

Specifying
▶ Page C174

Bullet Top Worksurfaces

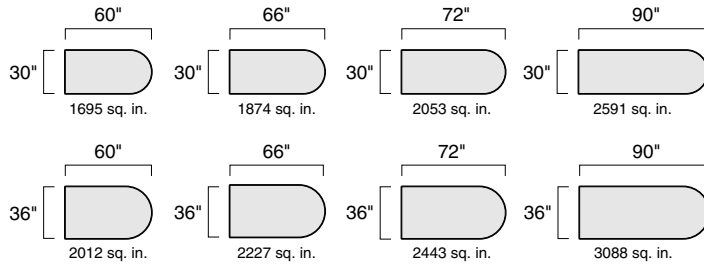

Actual dimensions of Wood Selections top depths are 24" and 30" as shown. Unlike Torus Edge tops, these Wood Selections tops do not provide a 1/2" gap between the back edge of the worksurface and the tiles. Square-inch measurements are exact.

Montage Wood Selections Statement of Line, continued

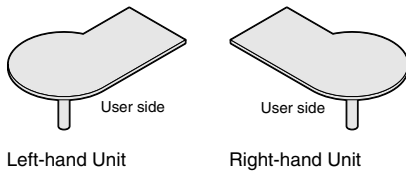

Specifying
▶ Page C178

P-Top Worksurfaces*

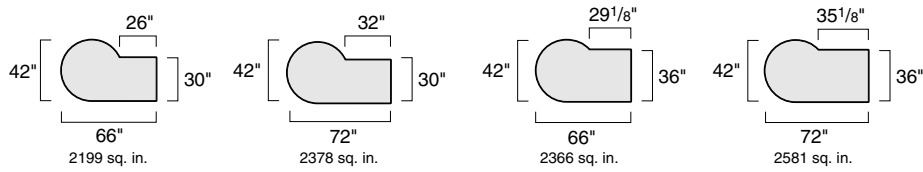

* Left-hand units shown.
Right-hand units available.

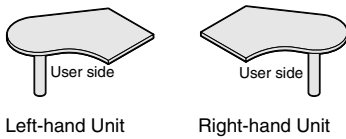

Specifying
▶ Page C180

Sock Top Worksurfaces*

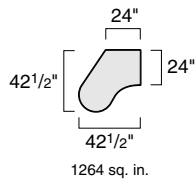

* Left-hand units shown.
Right-hand units available.

Actual dimensions of Wood Selections top depths are 24" and 30" as shown. Unlike Torus Edge tops, these Wood Selections tops do not provide a 1/2" gap between the back edge of the worksurface and the tiles. Square-inch measurements are exact.

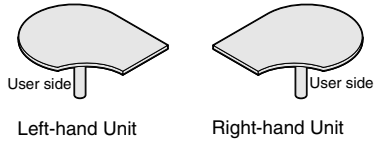

Specifying
▶ Page C182

Scoop Top Worksurfaces*

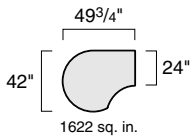

* Left-hand units shown.
Right-hand units available.

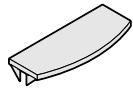

Specifying
▶ Page C184

Curved-Front Transaction Worksurfaces

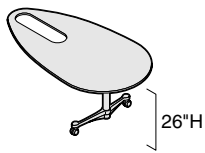

Specifying
▶ Page C189

Tether Table

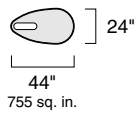

Actual dimensions of Wood Selections top depths are 24" and 30" as shown. Unlike Torus Edge tops, these Wood Selections tops do not provide a 1/2" gap between the back edge of the worksurface and the tiles. Square-inch measurements are exact.

Shells

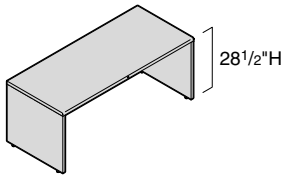

Specifying
▶ Page C190

Freestanding Desk Shells

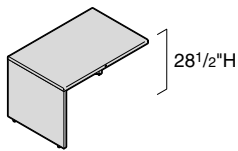
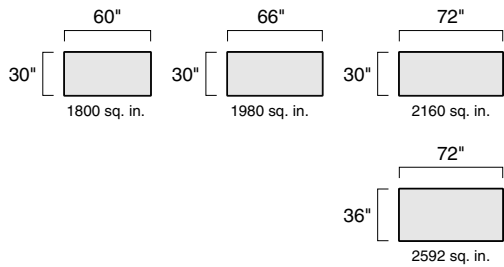

Specifying
▶ Page C192

Return Shells

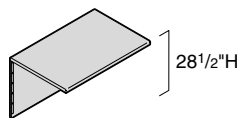
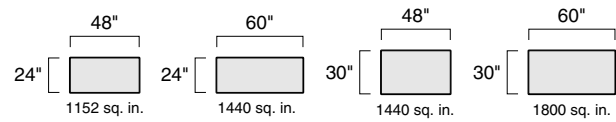

Specifying
▶ Page C194

Bridge Shells

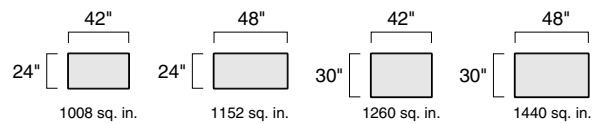

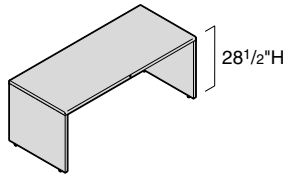

Specifying
▶ Page C196

Credenza Shells

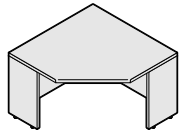
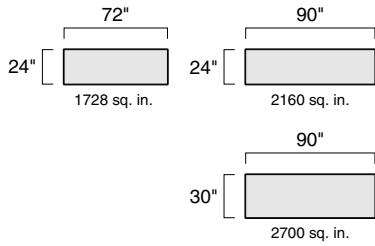

Specifying
▶ Page C198

Freestanding Corner Worksurface Shells

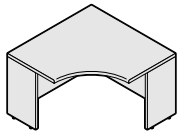
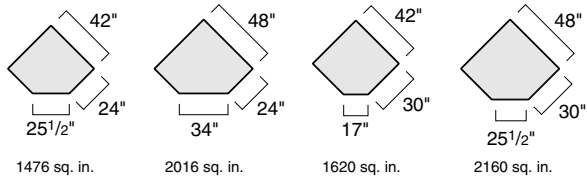

Specifying
▶ Page C199

Freestanding Cornerstone Worksurface Shells

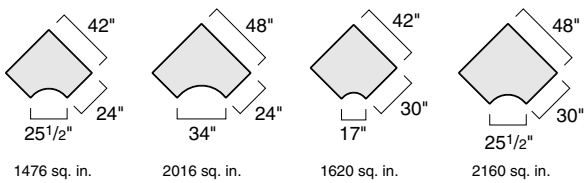

Montage Wood Selections Statement of Line, continued

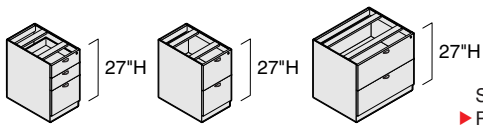

Specifying
▶ Page C206

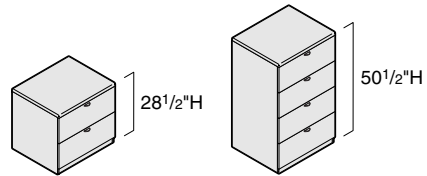

Specifying
▶ Page C212

Pedestals

	15"W	30"W	36"W
19"D		●	●
23"D	●		
24"D	●		
29"D	●		

Freestanding Lateral Files

	30"W	36"W*
24"D	●	●

*Available only in 28 1/2"H

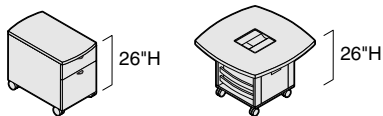

Specifying
▶ Pages C214–C217

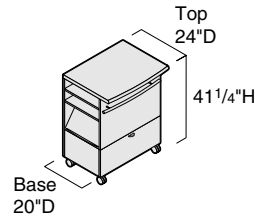

Specifying
▶ Page C218

Mobile Pedestals

	15 1/2"W	31 3/4"W
19"D	●	
31 3/4"D		●

Standing-Height Mobile Cabinet

	32"W
24"D	●

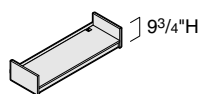

Specifying
▶ Page C220

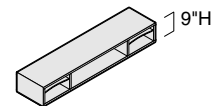

Specifying
▶ Page C221

Overhead Storage Shelves

	24"W	30"W	36"W	42"W	48"W	60"W
15 3/4"D	●	●	●	●	●	●

Organizer Shelves

	24"W	30"W	36"W	42"W	48"W	60"W	66"W	72"W
11 1/2"D	●	●	●	●	●	●	●	●
15"D	●	●	●	●	●	●	●	●

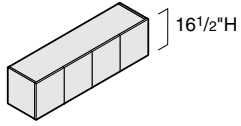

Specifying
▶ Page C222

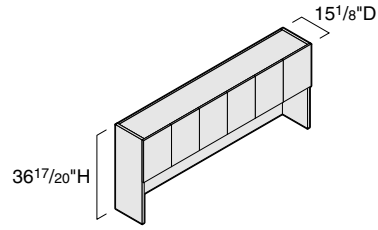

Specifying
▶ Page C223

Overhead Storage Cabinets

	24"W	30"W	36"W	42"W	48"W	60"W
16 1/2"D	●	●	●	●	●	●

Service Modules

	60"W	66"W	72"W	90"W
15 1/8"D	●	●	●	●

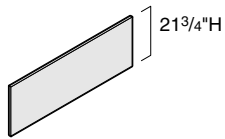

Specifying
▶ Page C224

Service Module Tackboards

60"W	66"W	72"W	90"W
●	●	●	●

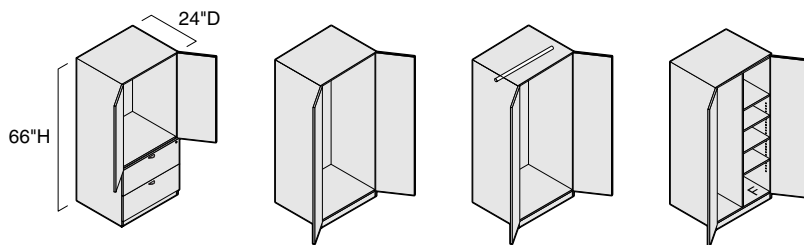

Specifying
▶ Page C226

Vertical Cabinets

30"W
66"H ●

Montage Wood Selections Statement of Line, continued

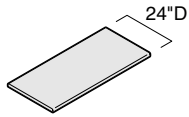

Specifying
▶ Page C228

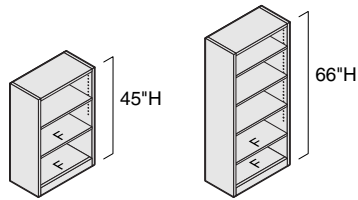

Specifying
▶ Page C229

Worksurfaces for Use Above 50 1/2"H Lateral File

	30 1/16"W	60 1/8"W	90 3/16"W
24"D	●	●	●

Bookcases

	30"W
15"D	●

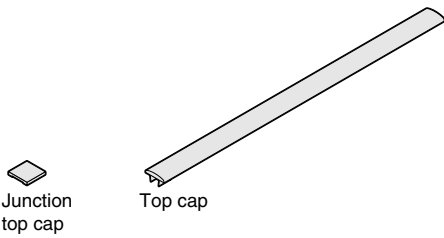

Specifying
▶ Page C230



Specifying
▶ Page C231

Wood Top Caps

	3"W	24"W	30"W	36"W	42"W	48"W
3"D	●	●	●	●	●	●

Wood Vertical End Trim

	20"H	45"H	65"H	85"H
3"W	●	●	●	●

Worksurface Wiring and Cabling



3-Piece Grommet
Specifying
▶ Page C166



4"-Square Grommet
Specifying
▶ Page C166

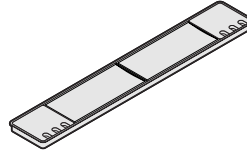

Channel Grommet
Specifying
▶ Page C166

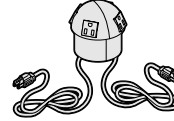

Power Spheres
Specifying
▶ Page C232



Power and Communication Spheres
Specifying
▶ Page C232



Communication Sphere
Specifying
▶ Page C233

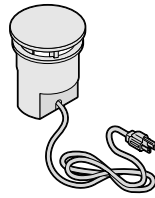

Round Power and Communication Port
Specifying
▶ Page C233



Cable and Fiber Reels
Specifying
▶ Page C234

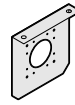

Termination Plate
Specifying
▶ Page C234



Vertical Wire Managers
Specifying
▶ Page C234

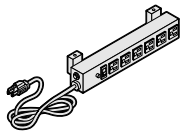

Power Strips
Specifying
▶ Page C235

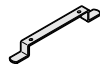

Cord Reels
Specifying
▶ Page C235

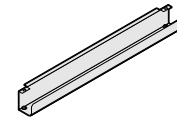

Cable Storage Tray
Specifying
▶ Page C235



Wire Guide Clips
Specifying
▶ Page C236

Montage

Statement of Line

Canopy lights are task lights that provide broad coverage and evenly balanced light that significantly minimizes glare. They offer a variety of mounting options independent of overhead storage. Canopy lights are designed to complement a variety of Steelcase furniture and many competitive furniture lines.

Depth 7 1/16"

Width 24"
36"
48"

Optics

Patented, crescent-shaped lens with specular aluminum reflector.

Scientifically designed reflector and crescent-shaped optics lens for low glare and broad distribution of light.

Ballast
Electronic

Electronic dimmer
Available

Canopy Lights

Worksurface-Mounted Canopy Light

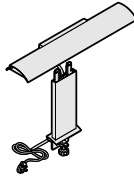

Specifying
▶ Page C238

Frame-Mounted Canopy Light

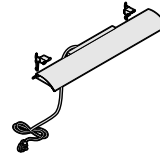

Specifying
▶ Page C240

Slatwall Tile-Mounted Canopy Light*

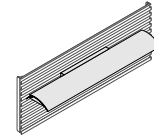

Specifying
▶ Page C240
Tip: Specify panel-mounted canopy light, and select appropriate mounting options.

Montage

Yes

Yes

Yes ①

Competitive

Yes

Yes ② ③

Yes ⑤

Architectural Drywall

No

Yes ④

No

- ① Use Montage slatwall tiles.
- ② Competitive products that can accommodate canopy lights by using the standard Answer, Avenir, and Series 9000 panel-mounting bracket include:
 - **All Steel** 8000
 - **American Seating Framework**
 - **Haworth** Unigroup, Places
 - **HON**
 - **Kimball** Cetra
 - **Knoll** Morrison, Equity, Rugby
 - **K1** System 3000
 - **La-Z-Boy** Contract
 - **Panel Concepts**
 - **Precision**
 - **SMED**
 - **Teknion**
 - **Trendway**
 - **Unicore**
 - **Xception**

- ③ Additional brackets can accommodate panel-mounted canopy lights on:
 - **Haworth** Premise
 - **Herman Miller** Action Office, Ethospace
 - **Knoll** System 6, System Z
- ④ Use optional architectural drywall brackets.
- ⑤ Use Details slatwall. Ordered separately.

* Also for use with Details slatwall.

Shelf lights mount into the recessed bottom of storage shelves and bins to illuminate the worksurface. Three types of shelf lights are available to control the quality of light for specific applications. Each type is compatible with Steelcase systems furniture and all major competitive furniture lines.

Shelf Lights

Storage-Mounted Lights

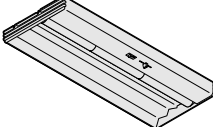
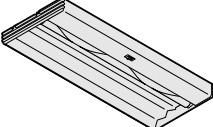
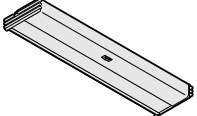
	Advanced Shelf Light	Standard Shelf Light	Utility Shelf Light
			
Mounting Options	<ul style="list-style-type: none"> • Universal mounting package (standard) • Competitive mounting package 	<ul style="list-style-type: none"> • Universal mounting package (standard) • Competitive mounting package 	<ul style="list-style-type: none"> • Universal mounting package (standard) • Competitive mounting package
	Specifying ▶ Page C244	Specifying ▶ Page C246	Specifying ▶ Page C248
Depth	9¼"	9¼"	5½"
Width	25", 37", or 49"	25", 37", or 49"	19", 25", 37", or 49"
Description	Provides maximum glare control, which makes it the best light for people who perform repetitive functions, do critical visual tasks, or have eyes that are particularly sensitive to light. Minimizing reflected glare is critical for these workers.	The right choice for the majority of people in today's workplace who switch frequently from task to task throughout the day.	Designed for use in display areas, service centers, under transaction tops, and other applications where glare control is not a primary consideration.
Optics	Faceted, specular aluminum reflector	Faceted, white reflector	White reflector
	Optics sleeve to reduce glare and improve light distribution	Contrast sleeve that can be manually rotated to vary light intensity	Prismatic lens—flat acrylic diffuser
Ballasts	<ul style="list-style-type: none"> • Economizer electronic ballast • Electronic ballast 	<ul style="list-style-type: none"> • Economizer electronic ballast • Electronic ballast 	<ul style="list-style-type: none"> • Electronic ballast • Magnetic normal-power-factor ballast
Electronic Dimmer	• Available	• Not available	• Not available
Lens Options	None	None	• Bat-wing lens option

Montage



Specifying Montage

Specifying Tips	C36
Specifying Tips for Montage Wood Selections	C38
Compatibility Tips	C40
Specifying Frames, Doors, and Junctions	C41
Specifying Frame Wiring and Cabling	C69
Specifying Tiles	C109
Specifying Worksurfaces	C123
Specifying Storage	C147
Specifying Montage Wood Selections	C165

Specifying Tips

General Tips

Standard Includes

- Case: paint
- Waterfall or rod pulls
- Dividers in box drawers
- Hanging file folder rail in file
- Lock in top drawer, key ran
- Polished Chrome
- Leveling glide
- Left- and right-hand filler ar

Review the features that are standard for each product before you begin to specify. You only need to include specifications for options, surface materials, and colors when you want a substitute for the standard.

To ensure that you do not overlook anything, approach the specifying process in a consistent order every time. Here are three common methods:

Specify products according to their order on the specifying pages.

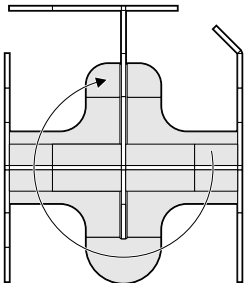

Specify all workstations using a formulated pattern, such as starting at the entrance to a workstation and moving clockwise.

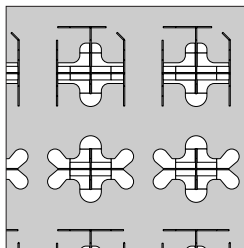

Specify each type of workstation in your installation and then determine how many of each type are needed.

Frames

Specify style numbers for all base frames and stack-on frames.

Specify enhanced standard frames, enhanced off-module frames, or a mix of both types of enhanced frames.

Specify enhanced stackers for use on enhanced frames.

Specify standard stackers for use on standard frames.

Choose frames with desk-height cavities factory installed for positions where you want to install desk-height powerways.

Keep track of which frames you want to accommodate power, and you'll have an easy way to cross-check with your specifications for powerkits and base covers. 45"H and 65"H frames accommodate powerways in their bases or at desk-height. 20"H frames accommodate cable routing but no other power distribution components.

Plan for 65"H or 86"H frames instead of a 45"H or 65"H frame with a 20"H frame stacked on top when the flexibility of variable heights is not needed. A single 65"H or 86"H frame will cost less than a 45"H or 65"H and a 20"H.

Add base covers and desk-height cavity covers to your list of specifications at the same time you specify frames so they are not overlooked.

Specify junctions by listing their style numbers and surface material.

No junctions are needed for frames that connect in a straight line at the same height or at different heights in off-module connections. But remember to specify end trim to finish the exposed portion of the taller frame.

Junctions are available to join frames in L, T, Y, X, V, and I configurations.

Specify junctions for use with lay-in cable tracks when specifying lay-in cable tracks.

Specify a wall-attachment bracket if you want a way to adjust space when installing a wall between two fixed points or when you suspect that the wall you want to connect frames to is not plumb. Remember that the 86"H wall-attachment bracket has no top cap.

Specify enhanced frames for new customers and existing customers with new sites.

Specify end-of-frame or mid-frame off-module brackets when doing off-module frame connections.

Doors

Remember that door frames are not structural. Use a stack-on frame above a door frame to provide stability. For applications where no frame is going to be installed above the door, a special top cap linked to adjacent frames is required. Contact your Steelcase area office to discuss your application.

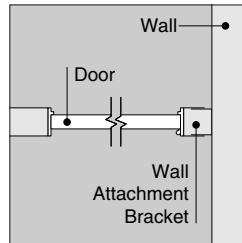

Specify a wall-attachment bracket to attach one side of a door frame to a building wall.

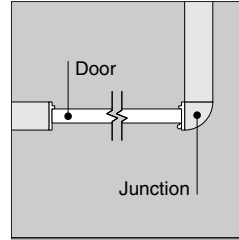

Use a junction on one side of a door frame to allow adjacent frames to be perpendicular to the door.

Determine if you need a left-hand or right-hand door by picturing yourself standing in the door frame with your back against the side of the frame with the hinges. If the door swings to your left, it's a left-hand door. If the door swings to your right, it's a right-hand door.

Wiring & Cabling

Specify a powerkit to correspond to the width of each frame with power. The frame-to-frame power connector cable that links adjacent powerkits together is included, so you don't need to order it.

Keep track of which surfaces will have desk-height cavity covers so that you can order smaller 13"H tiles for these frames.

Choose a base power-in to carry power from the floor of the building to the base of a frame. To extend power up to desk-height powerkits, you'll need to specify a base-to-desk-height power transfer cable. Remember that a power transfer cable must be routed through a junction.

Choose a top power-in to carry power from the ceiling down to either a powerkit at desk height or a powerkit in the frame base. Remember that a top power-in requires a power and cable pole of the appropriate size and that the power and cable pole must be positioned over a square L, T, or X junction to allow the top power-in cable to be routed.

Order covers. Plain base covers can be used in the bases of frames without powerkits or on the side of a frame where you don't want access to the powerkit's receptacle locations. Specify power base covers where you intend to have receptacles. Specify desk-height cavity covers for both sides of all the frames where you will have desk-height powerkits and want voice/data terminations and access to voice/data receptacles. Specify enhanced desk-height cavity covers for all frames manufactured after June 11, 2001.

Specify lay-in cable tracks, lay-in junction kits, lay-in change-of-height tracks, and end trims for use with lay-in tracks when lay-in cable management is desired.

Specify optional data openings below worksurface when extra voice/data plug-ins are needed.

Specify optional cable tray below the worksurface on a desk-height cavity cover when additional cord management is needed.

Specify power receptacles, voice/data receptacles, and filler plates to fill all the openings in the power base covers and desk-height cavity covers.

Specify Internode components when routing cable or power frame a spine wall to above or below worksurface mounts.

Tiles

Specify the style numbers and surface materials of all the tiles.

Draw an elevation view of both sides of each run of frames in the installation to help make sure you're including all the components in your specification and to help guide the installation. See example on next page.

Specify enhanced tiles for all frames manufactured after June 11, 2001.

Code each tile type and size with colors or a simple notation. Remember that frames with desk-height powerways will require 13"H tiles instead of 20"H tiles to allow space for the desk-height cavity covers. If you don't want access to the desk-height powerway's receptacle locations, you can use 20"H tiles on that side of the frame.

Worksurfaces

Specify style numbers and surface materials for worksurfaces.

Specify the supports separately. Remember that end-support brackets are ideal to support worksurfaces with clear kneespace underneath them. Using end-support brackets beside pedestals will produce a 1/2" gap between the end of the worksurface and the pedestal. To eliminate the gap, you can use the Montage pedestal without end-support brackets, and

the pedestal will be flush with the end of the worksurface. Or, you can use a cantilever along with a Context pedestal.

Specify a combination of on-module and off-module worksurface supports when supporting worksurfaces in off-module positions.

Order a supply of end-support brackets to support the back corners of corner worksurfaces and the visitor's side of bubble and jetty worksurfaces.

Add column legs to support bubble visitor, jetty, bubble jetty, and spanner worksurfaces. Each fanned spanner worksurface requires two column legs.

Remember that Montage pedestals can support some worksurfaces and eliminate the need for an end panel.

Avoid a Montage pedestal next to a cantilever because a small gap will result. Use a Context pedestal in these applications.

Avoid using two straight worksurfaces configured in a "L" because the torus edge on the front of one of the worksurfaces will butt the square edge on the side of the perpendicular worksurface.

Remember that worksurfaces mounted and supported off module use a combination of on-module and off-module supports.

Storage

Specify storage component style numbers, surface materials, and any specific keying information.

Specify off-module upper storage brackets for upper storage off-module applications.

Lighting

Specify style number and surface materials for all lights.

Example of Frame Run Elevations with Codes

N30	30" Non-Tackable (painted steel)	N48	48" Non-Tackable
F30	30" Non-Tackable (fabric over steel)	H48	48" High-Performance Acoustical
H30x13	30"W x 13"H High-Performance Acoustical	S48	48" Slatwall
S30x13	30"W x 13"H Slatwall	G48	48" Glass Package
C30	30" Desk Cavity Cover		

	30"	30"	48"	48"
65"	N30	N30	G48	G48
	N30	N30	N48	N48
	N30	N30	N48	N48

Tip: Don't duplicate your order for glass tile packages. Each glass tile package contains TWO glass tiles, so one package is sufficient for both sides of a frame.

	48"	48"	30"	30"
65"	G48	G48	F30	F30
	H48	S48	S30x13	H30x13
	N48	N48	C30	C30

Side 1

Side 2

Actual Specification

8	ZTSE3020	30" x 20" non-tackable tiles (painted)
2	ZTSE3020	30" x 20" non-tackable tiles (fabric)
1	ZSWE3013	30" x 13" slatwall tile
1	ZTHE3013	30" x 13" high-performance acoustical
2	ZPDCE30	30" x 7" desk-height cavity covers
1	ZTHE4820	48" x 20" high-performance acoustical
6	ZTSE4820	48" x 20" non-tackable tiles
2	ZTGE4820	48" x 20" glass tile packages
1	ZSWE4820	48" x 20" slatwall tile

Specifying Tips

For Montage Wood Selections

General Tips

Standard Includes

- Case: paint
- Waterfall or rod pulls
- Dividers in box drawers
- Hanging file folder rail in file
- Lock in top drawer, key ran
- Polished Chrome
- Leveling glide
- Left- and right-hand filler ar

Review the features that are standard for each product before you begin to specify. You only need to include specifications for options, surface materials, and colors when you want a substitute for the standard.

To ensure that you do not overlook anything, approach the specifying process in a consistent order every time. Here are three common methods:

Specify products according to their order on the specifying pages.

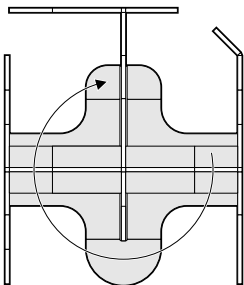

Specify all workstations using a formulated pattern, such as starting at the entrance to a workstation and moving clockwise.

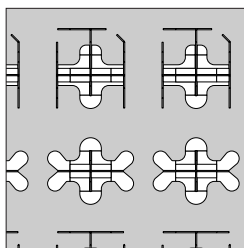

Specify each type of workstation in your installation and then determine how many of each type are needed.

Frames

Specify style numbers for all base frames and stack-on frames.

Specify enhanced standard frames, enhanced off-module frames, or a mix of both types of enhanced frames.

Specify enhanced stackers for use on enhanced frames.

Specify standard stackers for use on standard frames.

Choose frames with desk-height cavities factory installed for positions where you want to install desk-height powerways.

Keep track of which frames you want to accommodate power, and you'll have an easy way to cross-check with your specifications for powerkits and base covers. 45"H and 65"H frames accommodate powerways in their bases or at desk-height. 20"H frames accommodate cable routing but no other power distribution components.

Plan for 65"H or 86"H frames instead of a 45"H or 65"H frame with a 20"H frame stacked on top when the flexibility of variable heights is not needed. A single 65"H or 86"H frame will cost less than a 45"H or 65"H and a 20"H.

Add base covers and desk-height cavity covers to your list of specifications at the same time you specify frames so they are not overlooked.

Specify junctions by listing their style numbers and surface material.

No junctions are needed for frames that connect in a straight line at the same height or at different heights in off-module connections. But remember to specify end trim to finish the exposed portion of the taller frame.

Junctions are available to join frames in L, T, Y, X, V, and I configurations.

Specify junctions for use with lay-in cable tracks when specifying lay-in cable tracks.

Specify a wall-attachment bracket if you want a way to adjust space when installing a wall between two fixed points or when you suspect that the wall you want to connect frames to is not plumb. Remember that the 86"H wall-attachment bracket has no top cap.

Specify enhanced frames for new customers and existing customers with new sites.

Specify end-of-frame or mid-frame off-module brackets when doing off-module frame connections.

Doors

Remember that door frames are not structural. Use a stack-on frame above a door frame to provide stability. For applications where no frame is going to be installed above the door, a special top cap linked to adjacent frames is required. Contact your Steelcase area office to discuss your application.

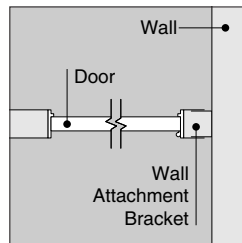

Specify a wall-attachment bracket to attach one side of a door frame to a building wall.

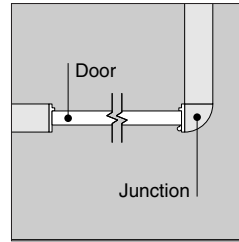

Use a junction on one side of a door frame to allow adjacent frames to be perpendicular to the door.

Determine if you need a left-hand or right-hand door by picturing yourself standing in the door frame with your back against the side of the frame with the hinges. If the door swings to your left, it's a left-hand door. If the door swings to your right, it's a right-hand door.

Wiring & Cabling

Specify a powerkit to correspond to the width of each frame with power. The frame-to-frame power connector cable that links adjacent powerkits together is included, so you don't need to order it.

Keep track of which surfaces will have desk-height cavity covers so that you can order smaller 13"H tiles for these frames.

Choose a base power-in to carry power from the floor of the building to the base of a frame. To extend power up to desk-height powerkits, you'll need to specify a base-to-desk-height power transfer cable. Remember that a power transfer cable must be routed through a junction.

Choose a top power-in to carry power from the ceiling down to either a powerkit at desk height or a powerkit in the frame base. Remember that a top power-in requires a power and cable pole of the appropriate size and that the power and cable pole must be positioned over a square L, T, or X junction to allow the top power-in cable to be routed.

Order covers. Plain base covers can be used in the bases of frames without powerkits or on the side of a frame where you don't want access to the powerkit's receptacle locations. Specify power base covers where you intend to have receptacles. Specify desk-height cavity covers for both sides of all the frames where you will have desk-height powerkits and want voice/data terminations and access to voice/data receptacles. Specify enhanced desk-height cavity covers for all frames manufactured after June 11, 2001.

Specify lay-in cable tracks, lay-in junction kits, lay-in change-of-height tracks, and end trims for use with lay-in tracks when lay-in cable management is desired.

Specify optional data openings below worksurface when extra voice/data plug-ins are needed.

Specify optional cable tray below the worksurface on a desk-height cavity cover when additional cord management is needed.

Specify power receptacles, voice/data receptacles, and filler plates to fill all the openings in the power base covers and desk-height cavity covers.

Specify Internode components when routing cable or power frame a spine wall to above or below wall mounts.

Tiles

Specify the style numbers and surface materials of all the tiles.

Draw an elevation view of both sides of each run of frames in the installation to help make sure you're including all the components in your specification and to help guide the installation. See example on next page.

Specify enhanced tiles for all frames manufactured after June 11, 2001.

Code each tile type and size with colors or a simple notation. Remember that frames with desk-height powerways will require 13"H tiles instead of 20"H tiles to allow space for the desk-height cavity covers. If you don't want access to the desk-height powerway's receptacle locations, you can use 20"H tiles on that side of the frame.

Worksurfaces

Specify style numbers and surface materials for worksurfaces.

Specify the supports separately. Remember that end-support brackets are ideal to support worksurfaces with clear kneespace underneath them. Using end-support brackets beside pedestals will produce a 1/2" gap between the end of the worksurface and the pedestal. To eliminate the gap, you can use the pedestal without end-support brackets, and the pedestal will be

flush with the end of the worksurface.

Specify a combination of on-module and off-module worksurface supports when supporting worksurfaces in off-module positions.

Order a corner worksurface bracket to support the back corner of corner worksurfaces and end support brackets to support the visitor's side of bubble and jetty worksurfaces.

Add column legs to support bullet and spanner worksurfaces.

Remember that pedestals can support some worksurfaces and eliminate the need for an end panel.

Avoid a Montage pedestal next to a cantilever because a small gap will result. Order flush-mount brackets for bridge and return application.

Remember to order flush-mount brackets for bridge and return application.

Avoid using two straight worksurfaces configured in a "L" because the edge profile on the front of one of the worksurfaces will butt the square edge on the side of the perpendicular worksurface.

Remember that worksurfaces mounted and supported off module use a combination of on-module and off-module supports.

Storage

Specify storage component style numbers, surface materials, and any specific keying information.

Specify off-module upper storage brackets for upper storage off-module applications.

Lighting

Specify style number and surface materials for all lights.

Example of Frame Run Elevations with Codes

N30	30" Non-Tackable (painted steel)	N48	48" Non-Tackable
F30	30" Non-Tackable (fabric over steel)	H48	48" High-Performance Acoustical
H30x13	30"W x 13"H High-Performance Acoustical	S48	48" Slatwall
S30x13	30"W x 13"H Slatwall	G48	48" Glass Package
C30	30" Desk Cavity Cover		

	30"	30"	48"	48"
65"	N30	N30	G48	G48
	N30	N30	N48	N48
	N30	N30	N48	N48

Side 1

	48"	48"	30"	30"
65"	G48	G48	F30	F30
	H48	S48	S30x13	H30x13
	N48	N48	C30	C30

Side 2

Tip: Don't duplicate your order for glass tile packages. Each glass tile package contains TWO glass tiles, so one package is sufficient for both sides of a frame.

Actual Specification

8	ZTS3020	30" x 20" non-tackable tiles (painted)
2	ZTS3020	30" x 20" non-tackable tiles (fabric)
1	ZSW3013	30" x 13" slatwall tile
1	ZTHPA3010	30" x 13" high-performance acoustical
2	ZPDC30	30" x 7" desk-height cavity covers
1	ZTHPA4820	48" x 20" high-performance acoustical
6	ZTS4820	48" x 20" non-tackable tiles
2	ZTG4820	48" x 20" glass tile packages
1	ZSW4820	48" x 20" slatwall tile

Compatibility Tips

Montage frames have been enhanced to offer off-modular planning. The attachment method on some Montage components has changed to accommodate this enhancement. On-module frames have also been enhanced to accept the new tile attachment method. The old standard frames and some of its components have been moved to the *Transitional Specification Guide*. Below is a matrix to use as a specification tip when specifying Montage frames and frame components for installed base and new installations.

Montage Enhancements Compatibility Matrix

	Standard Stackers*	Enhanced Stackers	Standard Tiles*	Enhanced Tiles	Enhanced Desk-High Cavity Covers	Standard Desk-High Cavity Covers*	Standard Pedestals	Off-Module Pedestals	Off-Module Upper Storage Bracket	Standard End Panels	Off-Module End Panels	Off-Module Worksurface Bracket	Off-Module Panel Bracket	Lay-In Cable Track
Standard Frame Shipped before 7/16/01	●		●			●	●			●				●
Standard Frame Shipped on or after 7/16/01	●		●	●	●	●	●			●				●
Enhanced Standard Frame Oct 2001 electronic catalog Nov 2001 1st ship		●		●	●		●			●				●
Enhanced Off-Module Frame		●		●	●		●	●	●	●	●	●	●	●

*Standard frames, standard stackers, standard tiles, and standard desk-high cavity covers are moving to transitional status to serve existing customers only.

Specifying Montage Frames, Doors, and Junctions

► For more detailed product information, see the *Montage Solutions Specification Guide* or consult your Steelcase dealer.

Frames

Enhanced Standard 45"H Two-High Frames (SIN 711.1)	C42
Enhanced Standard 65"H Three-High Frames (SIN 711.1)	C43
Enhanced Standard 86"H Four-High Frames (SIN 711.1)	C44
Enhanced Standard 20"H Single Stack-on Frames (SIN 711.1)	C45
Enhanced Off-Module 45"H Two-High Frames (SIN 711.1)	C46
Enhanced Off-Module 65"H Three-High Frames (SIN 711.1)	C47
Enhanced Off-Module 86"H Four-High Frames (SIN 711.1)	C48
Enhanced Off-Module 20"H Single Stack-on Frames (SIN 711.1)	C49
Enhanced Off-Module Frame Attachment Brackets (SIN 711.1)	C50
Door Frames (SIN 711.1)	C51
Doors and Lever Sets (SIN 711.1)	C52

Frame Junction Kits

Square L-Junctions (SIN 711.1)	C53
Radius L-Junctions (SIN 711.1)	C54
Chamfered L-Junctions (SIN 711.1)	C54
T-Junctions (SIN 711.1)	C55
X-Junctions (SIN 711.1)	C57
Y-Junctions (SIN 711.1)	C60
V-Junctions (SIN 711.1)	C62
I-Junctions (SIN 711.1)	C63

Trims and Brackets

Wood Top Caps (SIN 711.1)	C64
Wood Vertical End Trim (SIN 711.1)	C65
Metal Vertical End Trim (SIN 711.1)	C66
Wall-Attachment Bracket (SIN 711.1)	C66
Buttress (SIN 711.1)	C67
Fence Connectors (SIN 711.1)	C68

Enhanced Standard 45"H Two-High Frames

SIN 711.1

Tip: Frame is available in black or sterling only. You must select a finish.

Standard Includes	Required to Specify
<ul style="list-style-type: none"> • Frame: paint • Top cap: all paint price groups • Base cavity • Desk-height cavity, if selected • In-line connector hardware 	<ol style="list-style-type: none"> 1 Style number 2 Frame color number (see options below) 3 Paint color number for top cap 4 Options, if selected (see below) <p>▶ See <i>Surface Materials</i>, page C252.</p>

Options	Price	Required to Specify
Surface Materials <ul style="list-style-type: none"> • Black coating for frame • Sterling paint for frame 	No cost +\$38	Specify with 7710 Black. Specify with 4798 Sterling.
Top Cap <ul style="list-style-type: none"> • Omit top cap 	No cost	Specify <i>omit top cap</i> .
Related Products <ul style="list-style-type: none"> • Frame junction kits • Wood top caps • Vertical end trims • Frame wiring and cabling • Enhanced tiles • Enhanced desk-height cavity covers • Base covers • Lay-in cable tracks • Frame junction kits for lay-in cable tracks 		<ul style="list-style-type: none"> ▶ Page C53 ▶ Page C64 ▶ Pages C65–C66 ▶ Page C70 ▶ Pages C110–C120 ▶ Page C82 ▶ Page C80 ▶ Page C86 ▶ Page C90

Specification Information

Width	Style Number	Base Price
-------	--------------	------------

With Base Cavity

24"	ZFE2445	\$230
30"	ZFE3045	\$250
36"	ZFE3645	\$271
42"	ZFE4245	\$291
48"	ZFE4845	\$312

With Base and Desk-Height Cavities

24"	ZFE2445DC	\$297
30"	ZFE3045DC	\$328
36"	ZFE3645DC	\$359
42"	ZFE4245DC	\$389
48"	ZFE4845DC	\$420

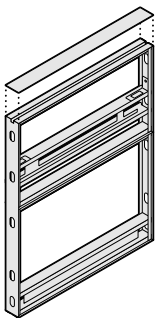
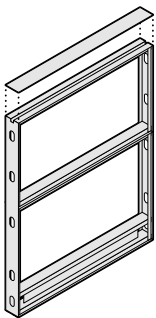

Enhanced Standard 65"H Three-High Frames

Enhanced Standard
65"H Three-High
Frames

SIN 711.1

Tip: Frame is available in black or sterling only. You must select a finish.

Standard Includes	Required to Specify
<ul style="list-style-type: none"> • Frame: paint • Top cap: all paint price groups • Base cavity • Desk-height cavity, if selected • In-line connector hardware 	<ul style="list-style-type: none"> 1 Style number 2 Frame color number (see options below) 3 Paint color number for top cap 4 Options, if selected (see below) ▶ See <i>Surface Materials</i>, page C252.

Options	Price	Required to Specify
Surface Materials <ul style="list-style-type: none"> • Black coating for frame • Sterling paint for frame 	No cost +\$38	Specify with 7710 Black. Specify with 4798 Sterling.
Top Cap <ul style="list-style-type: none"> • Omit top cap 	No cost	Specify omit top cap.
Related Products <ul style="list-style-type: none"> • Frame junction kits • Wood top caps • Vertical end trims • Frame wiring and cabling • Enhanced tiles • Enhanced desk-height cavity covers • Base covers • Lay-in cable tracks • Frame junction kits for lay-in cable tracks 		<ul style="list-style-type: none"> ▶ Page C53 ▶ Page C64 ▶ Pages C65–C66 ▶ Page C70 ▶ Pages C110–C120 ▶ Page C82 ▶ Page C80 ▶ Page C86 ▶ Page C90

Specification Information

Width	Style Number	Base Price
-------	--------------	------------

With Base Cavity

24"	ZFE2465	\$283
30"	ZFE3065	\$307
36"	ZFE3665	\$332
42"	ZFE4265	\$357
48"	ZFE4865	\$381

With Base and Desk-Height Cavities

24"	ZFE2465DC	\$348
30"	ZFE3065DC	\$379
36"	ZFE3665DC	\$410
42"	ZFE4265DC	\$441
48"	ZFE4865DC	\$471

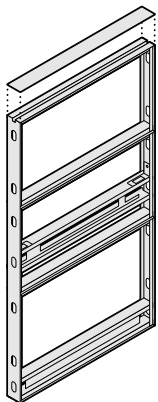
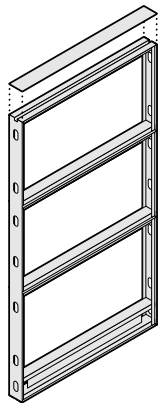

Montage

Enhanced Standard 86"H Four-High Frames

SIN 711.1

Tip: Frame is available in black or sterling only. You must select a finish.

Standard Includes	Required to Specify
<ul style="list-style-type: none"> • Frame: paint • Top cap: all paint price groups • Base cavity • Desk-height cavity, if selected • In-line connector hardware 	<ol style="list-style-type: none"> 1 Style number 2 Frame color number (see options below) 3 Paint color number for top cap 4 Options, if selected (see below) <p>▶ See <i>Surface Materials</i>, page C252.</p>

Options	Price	Required to Specify
Surface Materials <ul style="list-style-type: none"> • Black coating for frame • Sterling paint for frame 	No cost +\$38	Specify with 7710 Black. Specify with 4798 Sterling.
Top Cap <ul style="list-style-type: none"> • Omit top cap 	No cost	Specify omit top cap.
Related Products <ul style="list-style-type: none"> • Frame junction kits • Wood top caps • Vertical end trims • Frame wiring and cabling • Enhanced tiles • Enhanced desk-height cavity covers • Base covers • Lay-in cable tracks • Frame junction kits for lay-in cable tracks 		<ul style="list-style-type: none"> ▶ Page C53 ▶ Page C64 ▶ Pages C65–C66 ▶ Page C70 ▶ Pages C110–C120 ▶ Page C82 ▶ Page C80 ▶ Page C86 ▶ Page C90

Specification Information

Width	Style Number	Base Price
-------	--------------	------------

With Base Cavity

24"	ZFE2486	\$354
30"	ZFE3086	\$384
36"	ZFE3686	\$415
42"	ZFE4286	\$446
48"	ZFE4886	\$476

With Base and Desk-Height Cavities

24"	ZFE2486DC	\$435
30"	ZFE3086DC	\$474
36"	ZFE3686DC	\$513
42"	ZFE4286DC	\$551
48"	ZFE4886DC	\$589

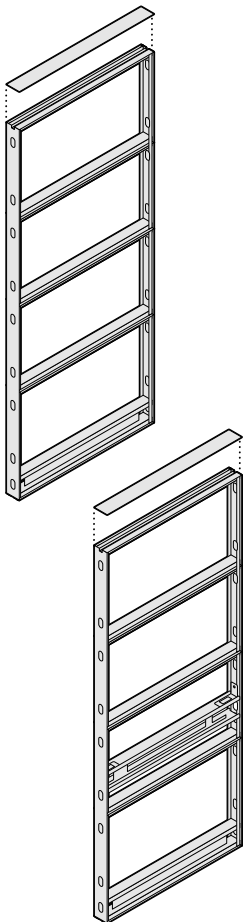

Enhanced Standard 20"H Single Stack-on Frames

Enhanced Standard
20"H Single
Stack-on Frames

SIN 711.1

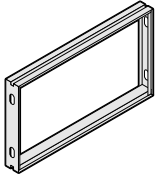

Tip: Frame is available in black or sterling only. You must select a finish.

Standard Includes	Required to Specify
-------------------	---------------------

- | | |
|--|--|
| Standard Includes | Required to Specify |
| <ul style="list-style-type: none"> • Frame: paint | <ul style="list-style-type: none"> 1 Style number 2 Frame color number (see options below) 3 Options, if selected (see below) ▶ See <i>Surface Materials</i>, page C252. |

Options	Price	Required to Specify
---------	-------	---------------------

Surface Materials	<ul style="list-style-type: none"> • Black coating for frame • Sterling paint for frame 	No cost +\$13	Specify with 7710 Black. Specify with 4798 Sterling.
Related Products	<ul style="list-style-type: none"> • Wood top caps • Vertical end trims • Frame wiring and cabling • Lay-in cable tracks • Enhanced tiles 		<ul style="list-style-type: none"> ▶ Page C64 ▶ Pages C65–C66 ▶ Page C70 ▶ Page C86 ▶ Pages C110–C120

Specification Information		
Width	Style Number	Base Price

Width	Style Number	Base Price
24"	ZFE2420	\$102
30"	ZFE3020	\$111
36"	ZFE3620	\$119
42"	ZFE4220	\$127
48"	ZFE4820	\$135
:	:	:

Montage

Enhanced Off-Module 45"H Two-High Frames

SIN 711.1

Tip: Frame is available in black or sterling only. You must select a finish.

Standard Includes	Required to Specify
<ul style="list-style-type: none"> • Frame: paint • Top cap: all paint price groups • Base cavity • Desk-height cavity, if selected • In-line connector hardware 	<ul style="list-style-type: none"> 1 Style number 2 Paint color number for top cap 3 Options, if selected (see below) ▶ See <i>Surface Materials</i>, page C252.

Options	Price	Required to Specify
Surface Materials <ul style="list-style-type: none"> • Black coating for frame • Sterling paint for frame 	No cost +\$38	Specify with 7710 Black. Specify with 4798 Sterling.
Top Cap <ul style="list-style-type: none"> • Omit top cap 	No cost	Specify omit top cap.
Related Products <ul style="list-style-type: none"> • Off-module frame attachment brackets • Wood top caps • Vertical end trims • Frame wiring and cabling • Enhanced tiles • Enhanced desk-height cavity covers • Base covers • Lay-in cable tracks • Frame junction kits for lay-in cable tracks 		<ul style="list-style-type: none"> ▶ Page C50 ▶ Page C64 ▶ Pages C65–C66 ▶ Page C70 ▶ Pages C110–C120 ▶ Page C82 ▶ Page C80 ▶ Page C86 ▶ Page C90

Specification Information

Width	Style Number	Base Price
-------	--------------	------------

With Base Cavity

24"	ZFOM2445	\$265
30"	ZFOM3045	\$290
36"	ZFOM3645	\$315
42"	ZFOM4245	\$335
48"	ZFOM4845	\$360

With Base and Desk-Height Cavities

24"	ZFOM2445DC	\$345
30"	ZFOM3045DC	\$380
36"	ZFOM3645DC	\$415
42"	ZFOM4245DC	\$450
48"	ZFOM4845DC	\$485

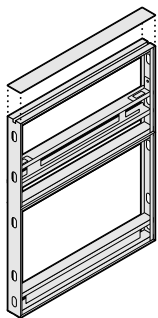
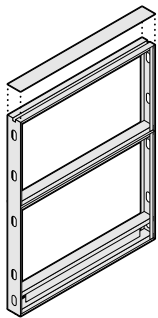

Enhanced Off-Module 65"H Three-High Frames

Enhanced Off-Module
65"H Two-High Frames

SIN 711.1

Tip: Frame is available in black or sterling only. You must select a finish.

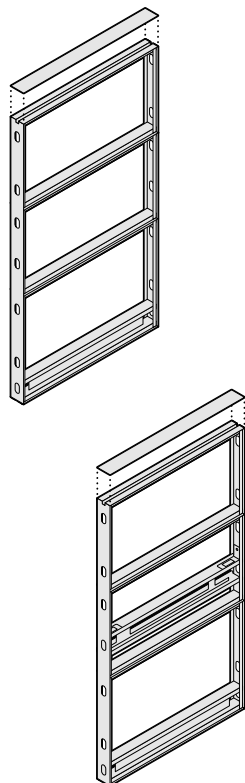

Standard Includes	Required to Specify
<ul style="list-style-type: none"> • Frame: paint • Top cap: all paint price groups • Base cavity • Desk-height cavity, if selected • In-line connector hardware 	<ul style="list-style-type: none"> 1 Style number 2 Frame color number (see options below) 3 Paint color number for top cap 4 Options, if selected (see below) ▶ See <i>Surface Materials</i>, page C252.

Options	Price	Required to Specify
Surface Materials <ul style="list-style-type: none"> • Black coating for frame • Sterling paint for frame 	No cost +\$38	Specify with 7710 Black. Specify with 4798 Sterling.
Top Cap <ul style="list-style-type: none"> • Omit top cap 	No cost	Specify omit top cap.
Related Products <ul style="list-style-type: none"> • Off-module frame attachment brackets • Wood top caps • Vertical end trims • Frame wiring and cabling • Enhanced tiles • Enhanced desk-height cavity covers • Base covers • Lay-in cable tracks • Frame junction kits for lay-in cable tracks 		<ul style="list-style-type: none"> ▶ Page C50 ▶ Page C64 ▶ Pages C65–C66 ▶ Page C70 ▶ Pages C110–C120 ▶ Page C82 ▶ Page C80 ▶ Page C86 ▶ Page C90

Specification Information

Width	Style Number	Base Price
-------	--------------	------------

With Base Cavity

24"	ZFOM2465	\$330
30"	ZFOM3065	\$355
36"	ZFOM3665	\$385
42"	ZFOM4265	\$415
48"	ZFOM4865	\$440

With Base and Desk-Height Cavities

24"	ZFOM2465DC	\$405
30"	ZFOM3065DC	\$440
36"	ZFOM3665DC	\$475
42"	ZFOM4265DC	\$510
48"	ZFOM4865DC	\$545

Montage

Enhanced Off-Module 86"H Four-High Frames

SIN 711.1

Tip: Frame is available in black or sterling only. You must select a finish.

Standard Includes	Required to Specify
<ul style="list-style-type: none"> • Frame: paint • Top cap: all paint price groups • Base cavity • Desk-height cavity, if selected • In-line connector hardware 	<ol style="list-style-type: none"> 1 Style number 2 Frame color number (see options below) 3 Paint color number for top cap 4 Options, if selected (see below) <p>▶ See <i>Surface Materials</i>, page C252.</p>

Options	Price	Required to Specify
Surface Materials <ul style="list-style-type: none"> • Black coating for frame • Sterling paint for frame 	No cost +\$38	Specify with 7710 Black. Specify with 4798 Sterling.
Top Cap <ul style="list-style-type: none"> • Omit top cap 	No cost	Specify omit top cap.
Related Products <ul style="list-style-type: none"> • Off-module frame attachment brackets • Wood top caps • Vertical end trims • Frame wiring and cabling • Enhanced tiles • Enhanced desk-height cavity covers • Base covers • Lay-in cable tracks • Frame junction kits for lay-in cable tracks 		<ul style="list-style-type: none"> ▶ Page C50 ▶ Page C64 ▶ Pages C65–C66 ▶ Page C70 ▶ Pages C110–C120 ▶ Page C82 ▶ Page C80 ▶ Page C86 ▶ Page C90

Specification Information

• Width	• Style Number	• Base Price
---------	----------------	--------------

With Base Cavity

24"	ZFOM2486	\$413
30"	ZFOM3086	\$444
36"	ZFOM3686	\$481
42"	ZFOM4286	\$519
48"	ZFOM4886	\$550

With Base and Desk-Height Cavities

24"	ZFOM2486DC	\$506
30"	ZFOM3086DC	\$550
36"	ZFOM3686DC	\$594
42"	ZFOM4286DC	\$638
48"	ZFOM4886DC	\$681

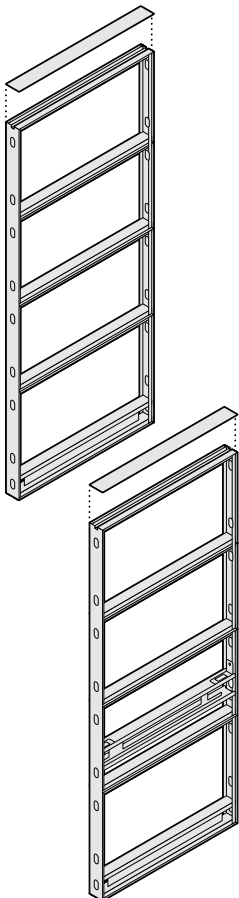

Enhanced Off-Module 20"H Single Stack-on Frames

Enhanced Off-Module
20"H Single Stack-on
Frames

SIN 711.1

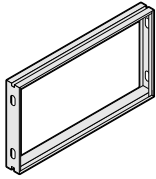

Tip: Frame is available in black or sterling only. You must select a finish.

Standard Includes	Required to Specify
-------------------	---------------------

- Frame: paint

- 1 Style number
- 2 Frame color number (see options below)
- 3 Options, if selected (see below)
- ▶ See *Surface Materials*, page C252.

Options	Price	Required to Specify
---------	-------	---------------------

Surface Materials

- Black coating for frame
- Sterling paint for frame

No cost
+\$13

Specify with 7710 *Black*.
Specify with 4798 *Sterling*.

Related Products

- Wood top caps
- Vertical end trims
- Frame wiring and cabling
- Lay-in cable tracks
- Enhanced tiles

- ▶ Page C64
- ▶ Pages C65–C66
- ▶ Page C70
- ▶ Page C86
- ▶ Pages C110–C120

Specification Information		
Width	Style Number	Base Price
24"	ZFOM2420	\$117
30"	ZFOM3020	\$128
36"	ZFOM3620	\$137
42"	ZFOM4220	\$146
48"	ZFOM4820	\$155
:	:	:

Montage

Enhanced Off-Module Frame Attachment Brackets

SIN 711.1

Tip: Brackets will not work over dome pattern tiles.

Tip: Off-module frame placement over glass is limited to one row of glass above 45".

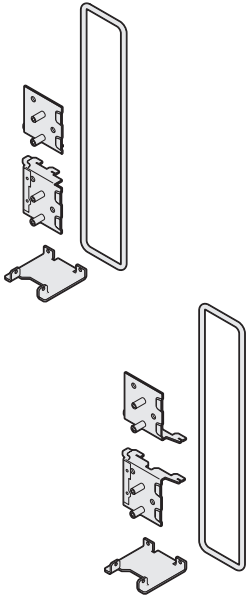

Standard Includes	Required to Specify
-------------------	---------------------

- Package of brackets: 0835 Black
- End-of-panel seal: 6000 Black plastic or 6659 Light Grey plastic

- 1 Style number
- 2 Plastic color number for end-of-panel seal

Specification Information

•Corresponding •Frame Height	•Style •Number	•Base •Price
---------------------------------	-------------------	-----------------

For End-of-Frame Connection

20"	ZBFOME20	\$ 40
45"	ZBFOME45	\$ 60
65"	ZBFOME65	\$ 90
86"	ZBFOME86	\$110
:	:	:

For Mid-Frame and In-Line Connection

20"	ZBFOMW20	\$ 40
45"	ZBFOMW45	\$ 60
65"	ZBFOMW65	\$ 90
86"	ZBFOMW86	\$110
:	:	:

Door Frames

SIN 711.1

Tip: Door frames are not structural. Use a stack-on frame above a doorway to provide stability. For applications where no frame is going to be installed above the door frame, a special top cap linked to adjacent frames is required. Contact your Steelcase area office to discuss your application.

Tip: You can order hollow-core doors locally to install in Montage door frames.

Tip: Special four-hinge frames required for veneer or heavier custom doors.
 ▶ See *Specials Handbook*.

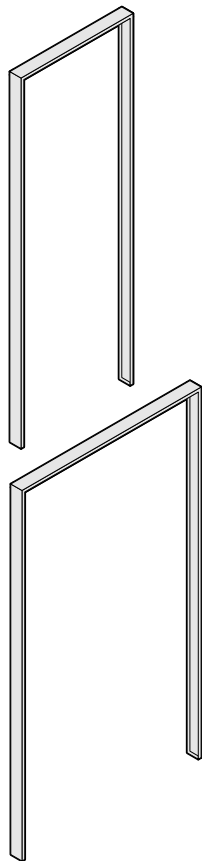

Standard Includes	Required to Specify
-------------------	---------------------

- | | |
|--|---|
| Standard Includes | Required to Specify |
| <ul style="list-style-type: none"> • Door frame with butt hinges: paint price group 1 | <ul style="list-style-type: none"> 1 Style number 2 Paint color number for door frame 3 Options, if selected (see below) ▶ See <i>Surface Materials</i>, page C252. |

Options	Price	Required to Specify
---------	-------	---------------------

Surface Materials	<ul style="list-style-type: none"> • Paint price group 1 • Paint price group 2 • Paint price group 3 	<ul style="list-style-type: none"> No cost +\$ 6 +\$10 	<ul style="list-style-type: none"> Specify paint color number. Specify paint color number. Specify paint color number.
--------------------------	---	---	---

Related Products	<ul style="list-style-type: none"> • Doors • Door lever sets 	<ul style="list-style-type: none"> ▶ Page C52 ▶ Page C52
-------------------------	--	--

Specification Information		
Dimensions	Style	Base
D	W	Number
:	:	Price
:	:	:

Left-Hand Door Frames

30"	86"	ZDF3086LH	\$246
36"	86"	ZDF3686LH	\$272
42"	86"	ZDF4286LH	\$297
:	:	:	:

Right-Hand Door Frames

30"	86"	ZDF3086RH	\$246
36"	86"	ZDF3686RH	\$272
42"	86"	ZDF4286RH	\$297
:	:	:	:

Double Door Frame

48"	86"	ZDF4886	\$338
:	:	:	:

Montage

Doors and Lever Sets

SIN 711.1

Tip: Door lever sets must be ordered separately.
 ▶ See Specification Information below.

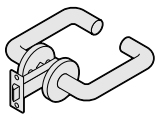
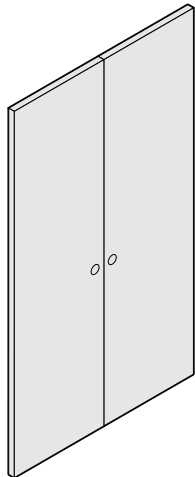
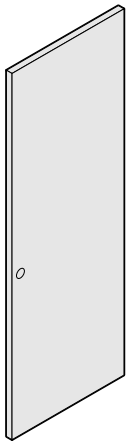

Standard Includes	Required to Specify
-------------------	---------------------

- Door: laminate
- 2 1/8"-diameter knob-set hole offset 2 3/4" and 1"-diameter latch hole pre-drilled.

- 1 Style number
- 2 Laminate color number for door
- ▶ See *Surface Materials*, page C252.

Related Products

- Door frames ▶ Page C51

Specification Information				
---------------------------	--	--	--	--

• Dimensions			• Style	• Price
D	W	H	Number	

Left-Hand Doors

1 3/8"	30"	86"	ZD3086LH	\$ 847
1 3/8"	36"	86"	ZD3686LH	\$1015
1 3/8"	42"	86"	ZD4286LH	\$1183

Right-Hand Doors

1 3/8"	30"	86"	ZD3086RH	\$ 847
1 3/8"	36"	86"	ZD3686RH	\$1015
1 3/8"	42"	86"	ZD4286RH	\$1183

Double Doors

1 3/8"	48"	86"	ZD4886	\$1428
--------	-----	-----	---------------	--------

Standard Includes	Required to Specify
-------------------	---------------------

- Door lever set: black

- Style number

Specification Information				
---------------------------	--	--	--	--

• Dimensions			• Style	• Price
D	W	H	Number	

Door Lever Sets

For Single Door

10"	7"	3"	ZDL	\$490
-----	----	----	------------	-------

For Double Doors

10"	7"	3"	ZDDL	\$880
-----	----	----	-------------	-------

Frame Junction Kits

SIN 711.1

Square L-Junctions

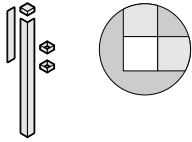

Tip: Brackets are for use with frames that do not have lay-in cable tracks mounted to them.

Standard Includes	Required to Specify
-------------------	---------------------

- Two-way square top cap: all paint price groups for aluminum or non-composite open-pore finishes for wood
- Two-way connectors
- One square L-cover: all paint price groups for aluminum or non-composite open-pore finishes for wood
- End trim, if applicable: all paint price groups for aluminum or non-composite open-pore finishes for wood

- 1 Style number
 - 2 Paint color number for top cap, cover, and end trim on aluminum frame
 - 3 Open-pore finish number for top cap, cover, and end trim on wood frame
- ▶ See *Surface Materials*, page C252.

Options	Price	Required to Specify
---------	-------	---------------------

- | | | |
|--------------------------|--|---|
| Surface Materials | <ul style="list-style-type: none"> • Customiz stain on wood | Prices below

Specify with <i>Customiz stain</i> .
▶ See <i>Surface Materials Reference Manual</i> . |
|--------------------------|--|---|

Specification Information

Height		Style Number	Base Price	Option (Add \$ to Base Price)
A	B			

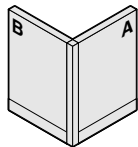

Same-Height Frame Kits

Aluminum				
45"	45"	ZJL44S	\$ 64	N.A.
65"	65"	ZJL66S	\$ 77	N.A.
86"	86"	ZJL88S	\$ 93	N.A.
Wood				
45"	45"	ZJL44SW	\$260	+\$23
65"	65"	ZJL66SW	\$285	+\$26
86"	86"	ZJL88SW	\$360	+\$28

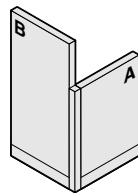

Change-of-Height Frame Kits

Aluminum				
45"	65"	ZJL46S	\$ 77	N.A.
45"	86"	ZJL48S	\$ 93	N.A.
65"	86"	ZJL68S	\$ 93	N.A.
Wood				
45"	65"	ZJL46SW	\$325	+\$23
45"	86"	ZJL48SW	\$365	+\$23
65"	86"	ZJL68SW	\$400	+\$26

Montage

Frame Junction Kits, continued

SIN 711.1

Radius L-Junctions

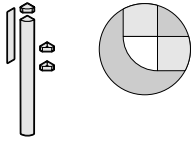

Tip: Brackets are for use with frames that do not have lay-in cable tracks mounted to them.

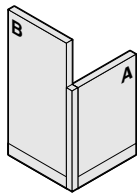
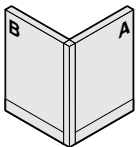

Standard Includes	Required to Specify
<ul style="list-style-type: none"> • Two-way radius top cap: all paint price groups • Two-way connectors • One radius L-cover: all paint price groups • End trim, if applicable: all paint price groups 	<ul style="list-style-type: none"> 1 Style number 2 Paint color number for top cap, cover, and end trim ▶ See <i>Surface Materials</i>, page C252.

Specification Information

• Height		• Style Number	• Price
A	B		

Same-Height Frame Kits

45"	45"	ZJL44R	\$64
65"	65"	ZJL66R	\$77
86"	86"	ZJL88R	\$93

Change-of-Height Frame Kits

45"	65"	ZJL46R	\$77
45"	86"	ZJL48R	\$93
65"	86"	ZJL68R	\$93

Chamfered L-Junctions

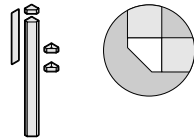

Tip: Brackets are for use with frames that do not have lay-in cable tracks mounted to them.

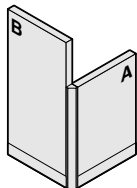
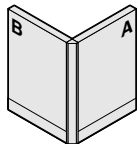

Standard Includes	Required to Specify
<ul style="list-style-type: none"> • Two-way chamfered top cap: all paint price groups • Two-way connectors • One chamfered L-cover: all paint price groups • End trim, if applicable: all paint price groups 	<ul style="list-style-type: none"> 1 Style number 2 Paint color number for top cap, cover, and end trim ▶ See <i>Surface Materials</i>, page C252.

Specification Information

• Height		• Style Number	• Price
A	B		

Same-Height Frame Kits

45"	45"	ZJL44C	\$64
65"	65"	ZJL66C	\$77
86"	86"	ZJL88C	\$93

Change-of-Height Frame Kits

45"	65"	ZJL46C	\$77
45"	86"	ZJL48C	\$93
65"	86"	ZJL68C	\$93

T-Junctions

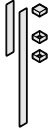

Tip: Brackets are for use with frames that do not have lay-in cable tracks mounted to them.

Standard Includes	Required to Specify
-------------------	---------------------

- Top cap, connectors, cover(s), and end trim, if applicable: all paint price groups for aluminum or non-composite open-pore finishes for wood

- 1 Style number
 - 2 Paint color number for top cap, cover(s), and end trim on aluminum frame
 - 3 Open-pore finish number for top cap, cover, and end trim on wood frame
- ▶ See *Surface Materials*, page C252.

Options	Price	Required to Specify
---------	-------	---------------------

Surface Materials

- Customiz stain on wood

Prices below

Specify with *Customiz stain*.
▶ See *Surface Materials Reference Manual*.

Specification Information					
---------------------------	--	--	--	--	--

Height			Style Number	Base Price	Option (Add \$ to Base Price)
A	B	C			

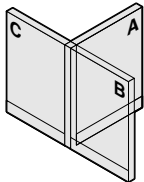

Same-Height Frame Kits

Aluminum					
45"	45"	45"	ZJT444	\$ 64	N.A.
65"	65"	65"	ZJT666	\$ 77	N.A.
86"	86"	86"	ZJT888	\$ 93	N.A.
Wood					
45"	45"	45"	ZJT444W	\$225	+\$23
65"	65"	65"	ZJT666W	\$260	+\$26
86"	86"	86"	ZJT888W	\$300	+\$28

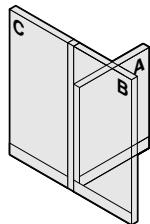

Change-of-Height Frame Kits

Aluminum					
45"	65"	65"	ZJT466	\$ 77	N.A.
45"	86"	86"	ZJT488	\$ 93	N.A.
65"	86"	86"	ZJT688	\$ 93	N.A.
Wood					
45"	65"	65"	ZJT466W	\$310	+\$34
45"	86"	86"	ZJT488W	\$340	+\$35
65"	86"	86"	ZJT688W	\$320	+\$39

▶ **T-Junction Change-of-Height Kits**, continued

X-Junctions

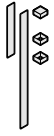

Tip: Brackets are for use with frames that do not have lay-in cable tracks mounted to them.

Standard Includes	Required to Specify
-------------------	---------------------

- | | |
|--|--|
| <ul style="list-style-type: none"> • Top cap, connectors, cover(s), and end trim, if applicable: all paint price groups for aluminum or non-composite open-pore finishes for wood | <ol style="list-style-type: none"> 1 Style number 2 Paint color number for top cap, cover(s), and end trim on aluminum frame 3 Open-pore finish number for top cap, cover, and end trim on wood frame 4 Options, if selected (see below) <p>▶ See <i>Surface Materials</i>, page C252.</p> |
|--|--|

Options	Price	Required to Specify
---------	-------	---------------------

- | | | |
|---|--------------|---|
| Surface Materials <ul style="list-style-type: none"> • Customiz stain on wood | Prices below | Specify with <i>Customiz stain</i> .
▶ See <i>Surface Materials Reference Manual</i> . |
|---|--------------|---|

Specification Information

Height				Style Number	Base Price	Option (Add \$ to Base Price)
A	B	C	D			

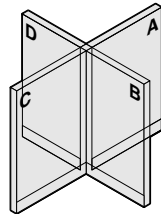

Same-Height Frame Kits

Aluminum						
45"	45"	45"	45"	ZJX4444	\$ 64	N.A.
65"	65"	65"	65"	ZJX6666	\$ 77	N.A.
86"	86"	86"	86"	ZJX8888	\$ 93	N.A.
Wood						
45"	45"	45"	45"	ZJX4444W	\$170	+\$11
65"	65"	65"	65"	ZJX6666W	\$200	+\$11
86"	86"	86"	86"	ZJX8888W	\$230	+\$11

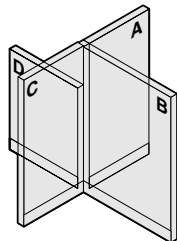

Change-of-Height Frame Kits

Aluminum						
65"	65"	65"	45"	ZJX6664	\$ 77	N.A.
86"	86"	86"	45"	ZJX8884	\$ 93	N.A.
86"	86"	86"	65"	ZJX8886	\$ 93	N.A.
Wood						
65"	65"	65"	45"	ZJX6664W	\$250	+\$22
86"	86"	86"	45"	ZJX8884W	\$280	+\$23
86"	86"	86"	65"	ZJX8886W	\$260	+\$22

▶ **X-Junction Change-of-Height Kits**, continued

Frame Junction Kits, continued

SIN 711.1

X-Junctions, continued

Specification Information

Height				Style Number	Base Price	Option (Add \$ to Base Price)
A	B	C	D			
						Customiz
						Stain

Change-of-Height Frame Kits, continued

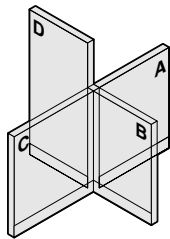

Aluminum						
45"	45"	45"	65"	ZJX4446	\$ 77	N.A.
45"	45"	45"	86"	ZJX4448	\$ 93	N.A.
65"	65"	65"	86"	ZJX6668	\$ 93	N.A.
Wood						
45"	45"	45"	65"	ZJX4446W	\$250	+\$22
45"	45"	45"	86"	ZJX4448W	\$280	+\$23
65"	65"	65"	86"	ZJX6668W	\$260	+\$22

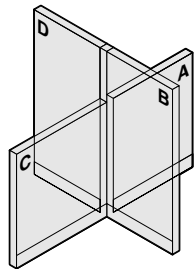

Aluminum						
45"	65"	45"	65"	ZJX4646	\$ 77	N.A.
45"	86"	45"	86"	ZJX4848	\$ 93	N.A.
65"	86"	65"	86"	ZJX6868	\$ 93	N.A.
Wood						
45"	65"	45"	65"	ZJX4646W	\$280	+\$33
45"	86"	45"	86"	ZJX4848W	\$300	+\$35
65"	86"	65"	86"	ZJX6868W	\$280	+\$33

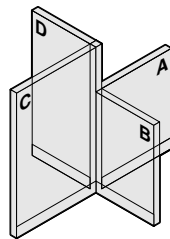

Aluminum						
45"	45"	65"	65"	ZJX4466	\$ 77	N.A.
45"	45"	86"	86"	ZJX4488	\$ 93	N.A.
65"	65"	86"	86"	ZJX6688	\$ 93	N.A.
Wood						
45"	45"	65"	65"	ZJX4466W	\$300	+\$22
45"	45"	86"	86"	ZJX4488W	\$320	+\$23
65"	65"	86"	86"	ZJX6688W	\$300	+\$26

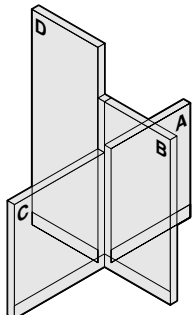

Aluminum						
45"	65"	45"	86"	ZJX4648	\$ 93	N.A.
Wood						
45"	65"	45"	86"	ZJX4648W	\$330	+\$44

► X-Junction Change-of-Height Kits, continued

X-Junctions, continued

Specification Information						
Height		C	D	Style Number	Base Price	Option (Add \$ to Base Price)
A	B					

Change-of-Height Frame Kits, continued

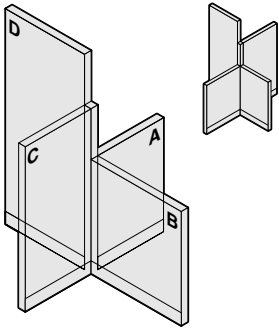

Aluminum

45"	45"	65"	86"	ZJX4468	\$ 93	N.A.
-----	-----	-----	-----	----------------	-------	------

Wood

45"	45"	65"	86"	ZJX4468W	\$365	+\$33
-----	-----	-----	-----	-----------------	-------	-------

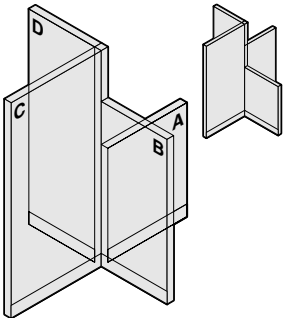

Aluminum

45"	65"	86"	86"	ZJX4688	\$ 93	N.A.
-----	-----	-----	-----	----------------	-------	------

Wood

45"	65"	86"	86"	ZJX4688W	\$320	+\$33
-----	-----	-----	-----	-----------------	-------	-------

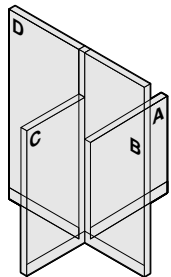

Aluminum

45"	86"	65"	86"	ZJX4868	\$ 93	N.A.
-----	-----	-----	-----	----------------	-------	------

Wood

45"	86"	65"	86"	ZJX4868W	\$300	+\$34
-----	-----	-----	-----	-----------------	-------	-------

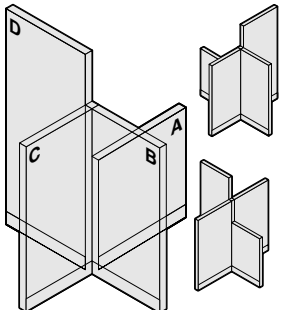

Aluminum

45"	65"	65"	86"	ZJX4668	\$ 93	N.A.
-----	-----	-----	-----	----------------	-------	------

Wood

45"	65"	65"	86"	ZJX4668W	\$300	+\$33
-----	-----	-----	-----	-----------------	-------	-------

Frame Junction Kits, continued

SIN 711.1

Y-Junctions

Tip: Brackets are for use with frames that do not have lay-in cable tracks mounted to them.

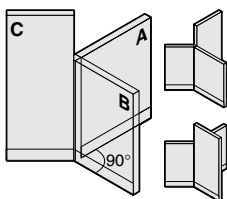
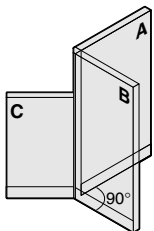
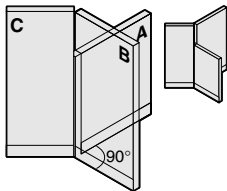
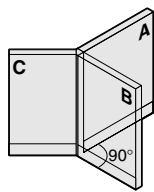

Standard Includes	Required to Specify
<ul style="list-style-type: none"> Two-way chamfered top cap: all paint price groups Two-way Y-junction connectors Cover with holes for Y-attachment: all paint price groups End trim, if applicable: all paint price groups 	<ul style="list-style-type: none"> 1 Style number 2 Paint color number for top cap, cover, and end trim ▶ See <i>Surface Materials</i>, page C252.

Specification Information

Height			Style Number	Price
A	B	C		

Same-Height Frame Kits

45"	45"	45"	ZJY444	\$64
65"	65"	65"	ZJY666	\$77
86"	86"	86"	ZJY888	\$93

Change-of-Height Frame Kits

45"	65"	65"	ZJY466	\$77
45"	86"	86"	ZJY488	\$93
65"	86"	86"	ZJY688	\$93

65"	65"	45"	ZJY664	\$77
86"	86"	45"	ZJY884	\$93
86"	86"	65"	ZJY886	\$93

45"	45"	65"	ZJY446	\$77
45"	45"	86"	ZJY448	\$93
65"	65"	86"	ZJY668	\$93

Y-Junctions, continued

Specification Information				
Height		C	Style Number	Price
A	B			

Change-of-Height Frame Kits, continued

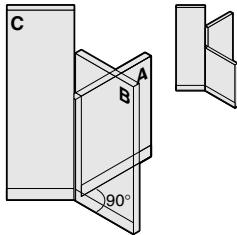

86"	65"	45"	ZJY864	\$93
-----	-----	-----	---------------	------

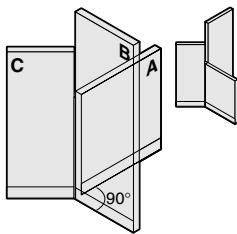

45"	65"	86"	ZJY468	\$93
-----	-----	-----	---------------	------

Tip: Brackets are for use with frames that do not have lay-in cable tracks mounted to them.

Tip: Kit number ZJY468 can be used in any Y configuration where either A or B frame is 45"H.

Tip: Above panel A, there will be a slight separation between panels B and C.

Tip: Junction will add 3/4" in linear direction to the panel between the 135° angles.

Frame Junction Kits, continued

SIN 711.1

V-Junctions

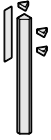

Tip: Brackets are for use with frames that do not have lay-in cable tracks mounted to them.

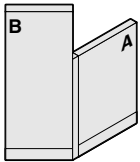
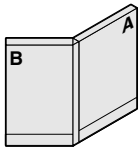

Standard Includes	Required to Specify
<ul style="list-style-type: none"> • Two-way 135° cap: all paint price groups • Two-way 135° connectors • One cover and end trim, if applicable: all paint price groups 	<ul style="list-style-type: none"> 1 Style number 2 Paint color number for top cap, cover, and end trim ▶ See <i>Surface Materials</i>, page C252.

Specification Information

• Height		• Style	• Price
A	B	Number	
:	:	:	:

Same-Height Frame Kits

45"	45"	ZJV44	\$64
65"	65"	ZJV66	\$77
86"	86"	ZJV88	\$93
:	:	:	:

Change-of-Height Frame Kits

45"	65"	ZJV46	\$77
45"	86"	ZJV48	\$93
65"	86"	ZJV68	\$93
:	:	:	:

I-Junctions



Tip: Brackets are for use with frames that do not have lay-in cable tracks mounted to them.

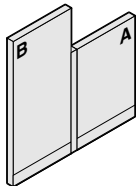
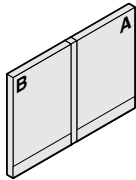

Standard Includes	Required to Specify
-------------------	---------------------

- | | |
|---|---|
| <ul style="list-style-type: none"> Two-way in-line top cap: all paint price groups for aluminum or non-composite open-pore finishes for wood Two-way in-line connectors Two covers and end trim, if applicable: all paint price groups for aluminum or non-composite open-pore finishes for wood | <ol style="list-style-type: none"> Style number Paint color number for top cap, cover, and end trim on aluminum frame Open-pore finish number for top cap, cover, and end trim on wood frame Options, if selected (see below) <p>▶ See <i>Surface Materials</i>, page C252.</p> |
|---|---|

Surface Materials	Options	Price	Required to Specify
-------------------	---------	-------	---------------------

- | | | | |
|--|--|--------------|---|
| | <ul style="list-style-type: none"> Customiz stain on wood | Prices below | Specify with <i>Customiz stain</i> .
▶ See <i>Surface Materials Reference Manual</i> . |
|--|--|--------------|---|

Specification Information

Height		Style Number	Base Price	Option (Add \$ to Base Price)
A	B			

Same-Height Frame Kits

Aluminum				
45"	45"	ZJI44	\$ 64	N.A.
65"	65"	ZJI66	\$ 77	N.A.
86"	86"	ZJI88	\$ 93	N.A.
Wood				
45"	45"	ZJI44W	\$250	+\$33
65"	65"	ZJI66W	\$275	+\$41
86"	86"	ZJI88W	\$350	+\$45

Change-of-Height Frame Kits

Aluminum				
45"	65"	ZJI46	\$ 77	N.A.
45"	86"	ZJI48	\$ 93	N.A.
65"	86"	ZJI68	\$ 93	N.A.
Wood				
45"	65"	ZJI46W	\$300	+\$44
45"	86"	ZJI48W	\$350	+\$46
65"	86"	ZJI68W	\$400	+\$52

Wood Top Caps

SIN 711.1

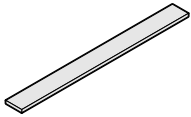

Top Cap



Junction Top Cap

Tip: All wood top caps have a square edge profile.

Tip: Wood top cap for junction package includes an aluminum junction bracket for proper alignment.

Tip: Top caps are solid wood and offered in wood finishes that match open-pore natural veneer finishes.

Tip: Wood top cap is already included with wood junction frame kits.

Tip: The fifth digit of the wood junction top cap style number indicates the junction (L, T, or X) to be used in the application.

Standard Includes	Required to Specify
<ul style="list-style-type: none"> • Top caps: solid wood • Junction top cap: solid wood 	<ul style="list-style-type: none"> 1 Style number 2 Wood color number for top cap 3 Options, if selected (see below) ▶ See <i>Surface Materials</i>, page C252.

Options	Price	Required to Specify
Surface Materials <ul style="list-style-type: none"> • Customiz stain on wood 	Prices below	Specify with <i>Customiz stain</i> . ▶ See <i>Surface Materials Reference Manual</i> .
Related Products <ul style="list-style-type: none"> • Frame junction kits • Wood tiles 		▶ Page C53 ▶ Page C116

Specification Information			
Width	Style Number	Base Price	Option (Add \$ to Base Price)
..... Customiz Stain

Wood Top Caps

24"	ZTC24W	\$94	+\$11
30"	ZTC30W	\$94	+\$12
36"	ZTC36W	\$94	+\$12
42"	ZTC42W	\$94	+\$13
48"	ZTC48W	\$94	+\$13
.....

Wood Junction Top Cap

3"	ZTCJL3W	\$45	+\$11
3"	ZTCJT3W	\$45	+\$11
3"	ZTCJX3W	\$45	+\$11
.....

Trims and Brackets

SIN 711.1

Wood Vertical End Trim



Tip: Vertical end trim is solid wood and offered in wood finishes that match open-pore natural veneer finishes.

Standard Includes	Required to Specify
<ul style="list-style-type: none"> Vertical end trim: solid wood 	1 Style number 2 Wood color number for vertical end trim 3 Options, if selected (see below) ▶ See <i>Surface Materials</i> , page C252.

Options	Price	Required to Specify
Surface Materials <ul style="list-style-type: none"> Customiz stain on wood 	Prices below	Specify with <i>Customiz stain</i> . ▶ See <i>Surface Materials Reference Manual</i> .
Related Products <ul style="list-style-type: none"> Frame junction kits Wood tiles 		▶ Page C53 ▶ Page C116

Specification Information			
Height	Style Number	Base Price	Option (Add \$ to Base Price)
20"	ZET20W	\$ 85	+\$11
40"	ZET40W	\$103	+\$12
45"	ZET45W	\$103	+\$12
65"	ZET65W	\$103	+\$15
85"	ZET86W	\$103	+\$17
:	:	:	:

Trims and Brackets, continued

SIN 711.1

Metal Vertical End Trim



Tip: When using lay-in cable tracks, you must specify end trims for use with lay-in cable tracks.

Standard Includes	Required to Specify
<ul style="list-style-type: none"> • End trim: all paint price groups • Attachment hardware: wing nuts 	<ul style="list-style-type: none"> 1 Style number 2 Paint color number for vertical end trim ▶ See <i>Surface Materials</i>, page C252.

Specification Information

Height	Style Number	Price
20"	ZET20	\$22
40"	ZET40	\$32
45"	ZET45	\$32
65"	ZET65	\$43
86"	ZET86	\$53
·	·	·

Wall-Attachment Bracket

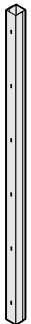

Standard Includes	Required to Specify
<ul style="list-style-type: none"> • Wall-attachment bracket: all paint price groups 	<ul style="list-style-type: none"> 1 Style number 2 Paint color number for wall-attachment bracket ▶ See <i>Surface Materials</i>, page C252.

Specification Information

Height	Style Number	Price
86"	ZWS86	\$142
·	·	·

Buttress

SIN 711.1

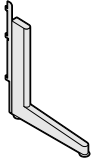

Standard Includes	Required to Specify
<ul style="list-style-type: none"> • Buttress: paint price group 1 	<ul style="list-style-type: none"> 1 Style number 2 Paint color number for buttress 3 Options, if selected (see below) ▶ See <i>Surface Materials</i>, page C252.

	Options	Price	Required to Specify
Surface	• Paint price group 1	No cost	Specify paint color number.
Materials	• Paint price group 2	+\$11	Specify paint color number.
	• Paint price group 3	+\$19	Specify paint color number.

Specification Information	
• Style Number	• Base Price
ZBUTTRESSL	\$248
ZBUTTRESSR	\$248
•	•



Fence Connectors

SIN 711.1

Standard Includes	Required to Specify
<ul style="list-style-type: none">Fence connector: 8043 Clear Anodized aluminumPost top cap: 6694 Slate plastic	Style number

Specification Information

Style Number	Price

Left-Hand Fence Connector

ZFENCELC	\$90
----------	------

Right-Hand Fence Connector

ZFENCERC	\$90
----------	------



Specifying Montage Frame Wiring and Cabling

► For more detailed product information, see the *Montage Solutions Specification Guide* or consult your Steelcase dealer.

Frame Wiring and Cabling

Powerkit System (SIN 711.1)	C70
Receptacles (SIN 711.1)	C78
Base Cavity and Desk-Height Cavity Covers (SIN 711.1)	C80
Consolidation Point (SIN 711.1)	C84
Lay-In Cable Track and Junctions (SIN 711.1)	C86
Internode Power and Communication Components (SIN 711.1)	C95

Powerkit System Frame Wiring and Cabling

SIN 711.1

Powerkits

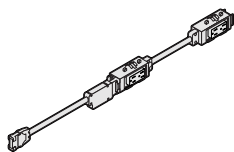

Tip: Remember to order receptacles.

▶ Page C78

Standard Includes	Required to Specify
<ul style="list-style-type: none"> Powerkit to accommodate modular receptacles on both sides: black plastic 	Style number

Specification Information

Width	Number of Duplex Receptacles Accommodated Per Side	Style Number	Price

4-Circuit, 3+1 Wiring Schematic

24"	1	ZB1PW24	\$177
30"	2	ZB1PW30	\$177
36"	2	ZB1PW36	\$177
42"	2	ZB1PW42	\$177
48"	2	ZB1PW48	\$177

4-Circuit, 2+2 Wiring Schematic

24"	1	ZB2PW24	\$177
30"	2	ZB2PW30	\$177
36"	2	ZB2PW36	\$177
42"	2	ZB2PW42	\$177
48"	2	ZB2PW48	\$177

3-Circuit, Separate Neutrals (3SN) Wiring Schematic

24"	1	ZB3PW24	\$177
30"	2	ZB3PW30	\$177
36"	2	ZB3PW36	\$177
42"	2	ZB3PW42	\$177
48"	2	ZB3PW48	\$177

Pass-Through Powerkits

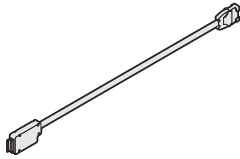

Standard Includes	Required to Specify
<ul style="list-style-type: none"> • Harness with modular connectors 	Style number

Specification Information

Width	Style Number	Price
:	:	:

4-Circuit, 3+1 Wiring Schematic

24"	ZB1PTR24	\$ 92
30"	ZB1PTR30	\$ 97
36"	ZB1PTR36	\$ 99
42"	ZB1PTR42	\$106
48"	ZB1PTR48	\$109
:	:	:

4-Circuit, 2+2 Wiring Schematic

24"	ZB2PTR24	\$ 92
30"	ZB2PTR30	\$ 97
36"	ZB2PTR36	\$ 99
42"	ZB2PTR42	\$106
48"	ZB2PTR48	\$109
:	:	:

3-Circuit, Separate Neutrals (3SN) Wiring Schematic

24"	ZB3PTR24	\$ 92
30"	ZB3PTR30	\$ 97
36"	ZB3PTR36	\$ 99
42"	ZB3PTR42	\$106
48"	ZB3PTR48	\$109
:	:	:

Montage

SIN 711.1

Power Infeeds

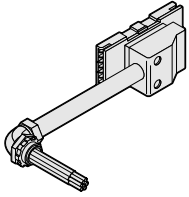

Tip: Power infeed occupies one receptacle location on powerkit.

Tip: Power infeeds are approved for use in San Francisco.

Standard Includes	Required to Specify
<ul style="list-style-type: none"> • Power infeed cover: black plastic only • 1/2"-diameter conduit: black plastic only 	Style number

Specification Information

Length	Style Number	Price
--------	--------------	-------

4-Circuit, 3+1 Wiring Schematic

6'	ZB1BPI6	\$165
12'	ZB1BPI12	\$195
:	:	:

4-Circuit, 2+2 Wiring Schematic

6'	ZB2BPI6	\$165
12'	ZB2BPI12	\$195
:	:	:

3-Circuit, Separate Neutrals (3SN) Wiring Schematic

6'	ZB3BPI6	\$165
12'	ZB3BPI12	\$195
:	:	:

Power Infeeds for Use in New York City

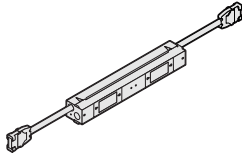

Tip: Power infeed occupies one receptacle location on powerkit.

Tip: Power infeed for use with 30" frame only. One power infeed per 30" frame.

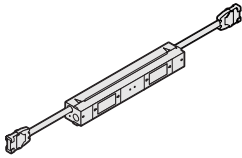

Standard Includes	Required to Specify
-------------------	---------------------

- Power infeed assembly
- 1/2"-diameter conduit

Style number

Specification Information		
Corresponding Panel Width	Style Number	Price

4-Circuit, 3+1 Wiring Schematic

24", 36", 42", 48"	ZB1BPNY	\$165
30"	ZB1BPNY30	\$185
:	:	:

4-Circuit, 2+2 Wiring Schematic

24", 36", 42", 48"	ZB2BPNY	\$165
30"	ZB2BPNY30	\$185
:	:	:

3-Circuit, Separate Neutrals (3SN) Wiring Schematic

24", 36", 42", 48"	ZB3BPNY	\$165
30"	ZB3BPNY30	\$185
:	:	:

Powerkit System Frame Wiring and Cabling, continued

SIN 711.1

Power Harnesses for Use with Power and Cable Pole

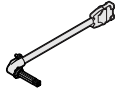

Tip: Power and cable pole must be specified separately.

Standard Includes		Required to Specify
<ul style="list-style-type: none"> • Harness with modular connector • Insulated, color-coded wires for hardwired connection to building power source 		Style number

Specification Information		
Length	Style Number	Price
4-Circuit, 3+1 Wiring Schematic		
12'	Z1TPI12	\$200
24'	Z1TPI24	\$305
:	:	:
4-Circuit, 2+2 Wiring Schematic		
12'	Z2TPI12	\$200
24'	Z2TPI24	\$305
:	:	:
3-Circuit, Separate Neutrals (3SN) Wiring Schematic		
12'	Z3TPI12	\$200
24'	Z3TPI24	\$305
:	:	:

Power and Cable Poles



Tip: Custom heights are available through Specials Engineering.

Tip: Base fiber-in is available for cable entry into frame at a point other than a junction.

Tip: Can be used with top power-in.

Standard Includes		Required to Specify
<ul style="list-style-type: none"> • Power and cable pole: paint price group 1 		1 Style number 2 Paint color number for power and cable pole 3 Options, if selected (see below) ▶ See <i>Surface Materials</i> , page C252.

Options	Price	Required to Specify
Surface Materials <ul style="list-style-type: none"> • Paint price group 1 • Paint price group 2 • Paint price group 3 	No cost +\$ 6 +\$10	Specify paint color number. Specify paint color number. Specify paint color number.

Specification Information		
Height	Style Number	Base Price
19"	ZPP19	\$55
40"	ZPP40	\$68
61"	ZPP61	\$82
:	:	:

Modular Harnesses for Base-to-Desk-Height Power Transfer and Off-Module Desk-Height Power Transfer Cable

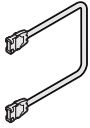

Tip: When used for off-module power transfer, use harnesses at desk height only.

Standard Includes	Required to Specify
-------------------	---------------------

- | | |
|--|--------------|
| <ul style="list-style-type: none"> Conduit with two modular connectors: black | Style number |
|--|--------------|

Specification Information

Length	Style Number	Price
48"	Z1BDT	\$115

4-Circuit, 3+1 Wiring Schematic

48"	Z1BDT	\$115
-----	-------	-------

4-Circuit, 2+2 Wiring Schematic

48"	Z2BDT	\$115
-----	-------	-------

3-Circuit, Separate Neutrals (3SN) Wiring Schematic

48"	Z3BDT	\$115
-----	-------	-------

Montage

Powerkit External Off-Module Spine-to-Fin Modular Jumpers

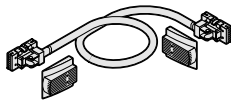

Tip: Jumper is used at base of panel only.

Tip: Jumper must be used with base covers for use with off-module jumper cable.

Standard Includes	Required to Specify
-------------------	---------------------

- | | |
|--|--------------|
| <ul style="list-style-type: none"> Jumper cable: zinc Jumper cable plug: black | Style number |
|--|--------------|

Specification Information

Style Number	Price
ZB1PJ12	\$182

4-Circuit, 3+1 Wiring Schematic

ZB1PJ12	\$182
---------	-------

4-Circuit, 2+2 Wiring Schematic

ZB2PJ12	\$182
---------	-------

3-Circuit, Separate Neutrals (3SN) Wiring Schematic

ZB3PJ12	\$182
---------	-------

Powerkit System Frame Wiring and Cabling, continued

SIN 711.1

Chicago Junction Boxes



Standard Includes	Required to Specify
<ul style="list-style-type: none"> • Carton of six junction boxes: zinc plated only • Base power-in covers • Receptacle faceplates 	Style number

Specification Information

Style Number	Price
ZCHIBOXB	\$265
ZCHIBOXB30	\$350

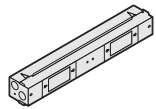

Tip: For use with 30" frame only. One box per 30" frame.

Retrofit Powerkits

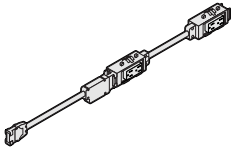

Tip: For use in Montage frames manufactured prior to March 20, 2000.

Tip: Retrofit powerkits work with other powerkit system components.

Tip: Remember to order receptacles.
▶ Page C78

Tip: Base and desk-height cavity covers must be ordered through Specials.

Standard Includes	Required to Specify
<ul style="list-style-type: none"> • Powerkit to accommodate modular receptacles on both sides: black plastic only 	Style number

Specification Information

Width	Number of Duplex Receptacles Accommodated Per Side	Style Number	Price
24"	2	ZB2PW24R	\$177
30"	4	ZB2PW30R	\$177
36"	4	ZB2PW36R	\$177
42"	4	ZB2PW42R	\$177
48"	4	ZB2PW48R	\$177

4-Circuit, 2+2 Wiring Schematic

24"	2	ZB2PW24R	\$177
30"	4	ZB2PW30R	\$177
36"	4	ZB2PW36R	\$177
42"	4	ZB2PW42R	\$177
48"	4	ZB2PW48R	\$177

Receptacles

For Use with Powerkits

SIN 711.1

15-Amp Receptacles

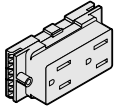

Standard Includes	Required to Specify
<ul style="list-style-type: none"> • Receptacle: plastic 	<ul style="list-style-type: none"> 1 Style number 2 Plastic color number for receptacle: <ul style="list-style-type: none"> 6000 Black 6651 Tungsten 6652 Titanium 6654 Vanadium 6697 Fog

Specification Information

Width	Style Number	Price	Width	Style Number	Price

4-Circuit, 3+1 Wiring Schematic

System Ground			Isolated Ground		
Line 1	ZB1R1SG	\$31	Line 1	ZB1R1IG	\$39
Line 2	ZB1R2SG	\$31	Line 2	ZB1R2IG	\$39
Line 3	ZB1R3SG	\$31	Line 3	ZB1R3IG	\$39
Line 4	ZB1R4SG	\$31	Line 4	ZB1R4IG	\$39

4-Circuit, 2+2 Wiring Schematic

System Ground			Isolated Ground		
Line 1	ZB2R1SG	\$31	Line 1	ZB2R1IG	\$39
Line 2	ZB2R2SG	\$31	Line 2	ZB2R2IG	\$39
Line 3	ZB2R3SG	\$31	Line 3	ZB2R3IG	\$39
Line 4	ZB2R4SG	\$31	Line 4	ZB2R4IG	\$39

3-Circuit, Separate Neutrals (3SN) Wiring Schematic

System Ground			Isolated Ground		
Line 1	ZB3R1SG	\$31	Line 1	ZB3R1IG	\$39
Line 2	ZB3R2SG	\$31	Line 2	ZB3R2IG	\$39
Line 3	ZB3R3SG	\$31	Line 3	ZB3R3IG	\$39

20-Amp Receptacles

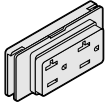

Standard Includes	Required to Specify
<ul style="list-style-type: none"> Receptacle: plastic 	1 Style number 2 Plastic color number for receptacle: 6000 Black 6651 Tungsten 6652 Titanium 6654 Vanadium 6697 Fog

Specification Information					
Width	Style Number	Price	Width	Style Number	Price
:	:	:	:	:	:

4-Circuit, 3+1 Wiring Schematic

System Ground			Isolated Ground		
Line 1	ZB1R1SGH	\$47	Line 1	ZB1R1IGH	\$60
Line 2	ZB1R2SGH	\$47	Line 2	ZB1R2IGH	\$60
Line 3	ZB1R3SGH	\$47	Line 3	ZB1R3IGH	\$60
Line 4	ZB1R4SGH	\$47	Line 4	ZB1R4IGH	\$60
:	:	:	:	:	:

4-Circuit, 2+2 Wiring Schematic

System Ground			Isolated Ground		
Line 1	ZB2R1SGH	\$47	Line 1	ZB2R1IGH	\$60
Line 2	ZB2R2SGH	\$47	Line 2	ZB2R2IGH	\$60
Line 3	ZB2R3SGH	\$47	Line 3	ZB2R3IGH	\$60
Line 4	ZB2R4SGH	\$47	Line 4	ZB2R4IGH	\$60
:	:	:	:	:	:

3-Circuit, Separate Neutrals (3SN) Wiring Schematic

System Ground			Isolated Ground		
Line 1	ZB3R1SGH	\$47	Line 1	ZB3R1IGH	\$60
Line 2	ZB3R2SGH	\$47	Line 2	ZB3R2IGH	\$60
Line 3	ZB3R3SGH	\$47	Line 3	ZB3R3IGH	\$60
:	:	:	:	:	:

Montage

Base Cavity and Desk-Height Cavity Covers

SIN 711.1

Powerkit Base Covers

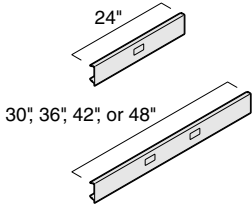

Tip: Powerkit base covers can be used with powerkit system only.

Standard Includes	Required to Specify
<ul style="list-style-type: none"> Base cover with receptacle openings and receptacle opening filler plates: all paint price groups 	<ul style="list-style-type: none"> 1 Style number 2 Paint color number for base cover ▶ See <i>Surface Materials</i>, page C252.

Specification Information

Length	Style Number	Price
24"	ZPBC24B	\$28
30"	ZPBC30B	\$28
36"	ZPBC36B	\$28
42"	ZPBC42B	\$28
48"	ZPBC48B	\$28
:	:	:

Powerkit Base Covers for Use with Off-Module Jumper Cable



Tip: Powerkit base covers can be used with powerkit system only.

Tip: Receptacle opening can be knocked out to create a jumper opening.

Standard Includes	Required to Specify
<ul style="list-style-type: none"> Base cover with standard decora-size power openings: all paint price groups 	<ul style="list-style-type: none"> 1 Style number 2 Paint color number for base cover ▶ See <i>Surface Materials</i>, page C252.

Specification Information

Length	Style Number	Price
24"	ZPBCJ24B	\$40
30"	ZPBCJ30B	\$40
36"	ZPBCJ36B	\$40
42"	ZPBCJ42B	\$40
48"	ZPBCJ48B	\$40
:	:	:

Outlet Filler Plate



Tip: Paint color of outlet filler plate can match or complement base cover.

Standard Includes	Required to Specify
-------------------	---------------------

- Outlet filler plate: all paint price groups

- 1 Style number
- 2 Paint color number for plate
- ▶ See *Surface Materials*, page C252.

Specification Information				
• Dimensions			• Style	• Price
D	W	H	Number	

D	W	H	Style Number	Price
1/16"	1 3/4"	2"	ZFP	\$8

Plain Base Covers

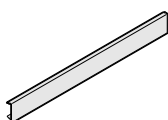

Tip: Base covers for frames are ordered individually to allow you to combine plain and power base covers on opposite sides of a frame or to specify different paint colors on the base covers on opposite sides of a frame.

Standard Includes	Required to Specify
-------------------	---------------------

- Base cover: all paint price groups

- 1 Style number
- 2 Paint color number for base cover
- ▶ See *Surface Materials*, page C252.

Specification Information		
• Width	• Style	• Price
	Number	

Width	Style Number	Price
24"	ZBC24	\$29
30"	ZBC30	\$29
36"	ZBC36	\$29
42"	ZBC42	\$29
48"	ZBC48	\$29

Base Cavity and Desk-Height Cavity Covers, continued

SIN 711.1

Powerkit Enhanced Desk-Height Cavity Covers

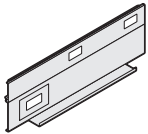
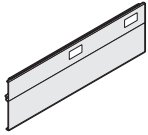

Tip: Powerkit desk-height cavity covers can be used with powerkit system only.

Tip: Enhanced covers work with enhanced frames and standard frames shipped after June 11, 2001.

Tip: Desk-height cavity covers with 36"W to 48"W has an option for two Decora/NEMA data openings below worksurface.

Standard Includes	Required to Specify
<ul style="list-style-type: none"> • Base cover with receptacle openings and one decora data opening above the worksurface: all paint price groups • Lower beltway cover without data openings • Two cable carriers • Snap-in fillers 	<ol style="list-style-type: none"> 1 Style number 2 Paint color number for base cover 3 Options, if selected (see below) <p>▶ See <i>Surface Materials</i>, page C252.</p>

Options	Price	Required to Specify
• Cable tray	+\$17	Specify with cable tray.
• Decora/NEMA data openings below worksurface	+\$35	Specify with openings below worksurface.

Specification Information		
Length	Style Number	Base Price
24"	ZPEDC24B	\$31
30"	ZPEDC30B	\$35
36"	ZPEDC36B	\$43
42"	ZPEDC42B	\$49
48"	ZPEDC48B	\$49

Cable Carrier

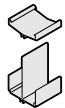

Tip: Cable carrier cannot be used with frames that have glass inserts.

Tip: Cable carriers can be stacked together.

Tip: Two cable carriers are provided with each desk-height cavity cover. Order additional carriers separately.

Tip: Other worksurface wire and cable management accessories are available in the Avenir Specification Guide.

Standard Includes	Required to Specify
• Cable carrier: black plastic	Style number

Specification Information	
Style Number	Price
ZCC	\$5

Desk-Height Cavities

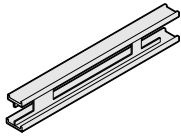

Tip: Frames are available with factory-installed desk-height cavities. Order desk-height cavities separately to upgrade a frame in the field to accept a powerkit (PK) or powerway (PW).

Standard Includes	Required to Specify
<ul style="list-style-type: none"> Desk-height cavity: paint 	1 Style number 2 Paint color number for desk-height cavity: 4798 Sterling 7710 Black

Specification Information		
Width	Style Number	Price
24"	ZDHC24	\$ 65
30"	ZDHC30	\$ 75
36"	ZDHC36	\$ 85
42"	ZDHC42	\$ 95
48"	ZDHC48	\$105
:	:	:

Enhanced Non-Tackable Tiles with Cutout and Base Fiber-In

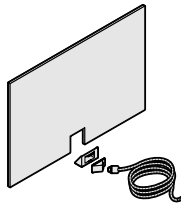

Tip: Base fiber-in tile alone can be ordered as a part. Contact your local Steelcase representative for details.

Tip: Steel patterned tiles are not available on base fiber-in tiles.

Standard Includes	Required to Specify
<ul style="list-style-type: none"> Tile: paint price group 1 Wedge-shaped connector, if applicable: black plastic only 6'-long, 3/4" inside diameter conduit, if applicable: black plastic only 	1 Style number 2 Paint color number for tile surface 3 Options, if selected (see below) ▶ See <i>Surface Materials</i> , page C252.

Options	Price	Required to Specify
Surface Materials <ul style="list-style-type: none"> Paint price group 1 Paint price group 2 Paint price group 3 	No cost +\$ 6 +\$10	Specify paint color number. Specify paint color number. Specify paint color number.
Tile surface <ul style="list-style-type: none"> Fabric price group 1 Fabric price group 2 Fabric price group 3 Fabric price group 4 Fabric price group 5 Fabric price group COM 	No cost +\$13 +\$22 +\$32 +\$50 +\$15	Specify fabric color number. Specify fabric color number. Specify fabric color number. Specify fabric color number. Specify fabric color number. Specify fabric color number. ▶ See <i>Surface Materials Reference Manual</i> to specify.

Specification Information		
Width	Style Number	Base Price
24"	ZTFE2420	\$120
30"	ZTFE3020	\$127
36"	ZTFE3620	\$134
42"	ZTFE4220	\$141
48"	ZTFE4820	\$148
:	:	:

Consolidation Point

SIN 711.1

Consolidation Point Kit

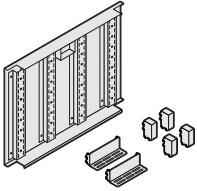

Standard Includes	Required to Specify
-------------------	---------------------

- Back panel: black paint
- Mounting hardware
- Two pairs of consolidation point mounting brackets: black only
- Two cable managers: black only

Style number

Related Products

- Consolidation point locking door tile

▶ Page C120

Specification Information	
---------------------------	--

• Style Number	• Price
ZCPK	\$249

Consolidation Point Mounting Brackets

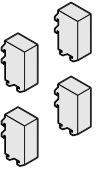

Tip: Order these mounting brackets to meet additional cabling needs when necessary.

Standard Includes	Required to Specify
-------------------	---------------------

- Carton of two pairs of mounting brackets: black only

Style number

Related Products

- Consolidation point locking door tile

▶ Page C120

Specification Information	
---------------------------	--

• Style Number	• Price
ZCPMB	\$46

Consolidation Point Cable Manager

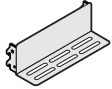

Tip: Order these cable managers to meet additional cabling needs when necessary.

Standard Includes	Required to Specify
-------------------	---------------------

- Two cable managers: black only

Style number

Related Products

- Consolidation point locking door tile

▶ Page C120

Specification Information	
Style Number	Price

Style Number	Price
ZPCPM	\$43
.	.

Lay-In Cable Track and Junctions

SIN 711.1

Lay-In Cable Track and Cover

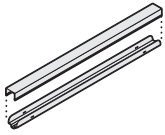

Tip: Junction kits and end trims must be specified for use with lay-in cable track.

Standard Includes	Required to Specify
-------------------	---------------------

- Cover: all paint price groups
- Track: black only
- Connectors

- 1 Style number
- 2 Paint color number for cover
- ▶ See *Surface Materials*, page C252.

Related Products

- Lay-in cable track change-of-height and end-of-run covers
- Lay-in cable track frame junction kits
- Lay-in cable track vertical end trims

- ▶ Page C87
- ▶ Pages C90–C94
- ▶ Page C94

Specification Information		
Width	Style Number	Price

Width	Style Number	Price
24"	ZFC24	\$87
30"	ZFC30	\$89
36"	ZFC36	\$91
42"	ZFC42	\$93
48"	ZFC48	\$95
:	:	:

Lay-In Cable Track and Cover

With Change-of-Height Cutout

Tip: Junction kits and end trims must be specified for use with lay-in cable track.

Standard Includes	Required to Specify
-------------------	---------------------

- Cover: all paint price groups
- Track: black only
- Connectors

- 1 Style number
- 2 Paint color number for cover
- ▶ See *Surface Materials*, page C252.

Related Products

- Lay-in cable track frame junction kits
- Lay-in cable track vertical end trims

- ▶ Pages C90–C94
- ▶ Page C94

Specification Information		
Width	Style Number	Price

Width	Style Number	Price
-------	--------------	-------

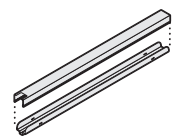

With Change-of-Height Cutout on One Side

24"	ZFC24CH1	\$87
30"	ZFC30CH1	\$89
36"	ZFC36CH1	\$91
42"	ZFC42CH1	\$93
48"	ZFC48CH1	\$95
⋮	⋮	⋮

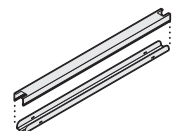

With Change-of-Height Cutout on Both Sides

24"	ZFC24CH2	\$87
30"	ZFC30CH2	\$89
36"	ZFC36CH2	\$91
42"	ZFC42CH2	\$93
48"	ZFC48CH2	\$95
⋮	⋮	⋮

Lay-In Cable Track and Cover

For Change-of-Height

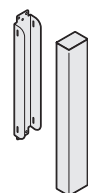

Tip: Must use with a lay-in cable track and cover with cutouts on one or both ends.

Standard Includes	Required to Specify
-------------------	---------------------

- Change-of-height package
- Connectors

- 1 Style number
- 2 Paint color number for cover
- ▶ See *Surface Materials*, page C252.

Specification Information		
Height	Style Number	Price

Height	Style Number	Price
--------	--------------	-------

20"	ZFC20CH	\$53
40"	ZFC40CH	\$62
⋮	⋮	⋮

Lay-In Cable Track and Junctions, continued

SIN 711.1

End Cap for Lay-In Cable Track

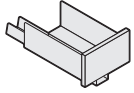

Tip: End cap for lay-in cable track is used in applications where vertical end trim cannot be used.

Standard Includes	Required to Specify
<ul style="list-style-type: none">• End cap: all paint price groups	<ul style="list-style-type: none">1 Style number2 Paint color number for end cap▶ See <i>Surface Materials</i>, page C252.

Specification Information

•Style Number	•Price
ZECT	\$24
.	.
.	.

Lay-In Cable Track and Junctions, continued

SIN 711.1

Frame Junction Kits

For Use with Frames with a Lay-In Cable Track

Standard Includes	Required to Specify
<ul style="list-style-type: none"> • Top cap: all paint price groups • Connectors • Square cover: all paint price groups • End trim, if applicable: all paint price groups 	<ul style="list-style-type: none"> 1 Style number 2 Paint color number for top cap, square cover, and end trim ▶ See <i>Surface Materials</i>, page C252.

Specification Information

• Dimensions				• Style Number	• Price
A	B	C	D		

Square L-Junctions

Same-Height Frame Kits

45"	45"	N.A.	N.A.	ZJL44SCT	\$ 87
65"	65"	N.A.	N.A.	ZJL66SCT	\$ 97
86"	86"	N.A.	N.A.	ZJL88SCT	\$112

Change-of-Height Frame Kits

45"	65"	N.A.	N.A.	ZJL46SCT	\$ 97
45"	86"	N.A.	N.A.	ZJL48SCT	\$107
65"	86"	N.A.	N.A.	ZJL68SCT	\$122

▶ **Specification Information, continued on next page**

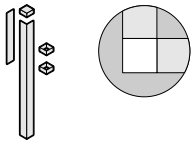

Tip: Brackets are for use with frames that have lay-in cable tracks mounted to them.

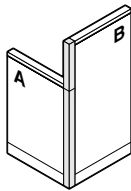
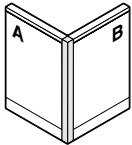

► **Specification Information, continued**

Specification Information

• Dimensions				• Style Number	• Price
A	B	C	D		

T-Junctions

Same-Height Frame Kits

45"	45"	45"	N.A.	ZJT444CT	\$ 87
65"	65"	65"	N.A.	ZJT666CT	\$ 97
86"	86"	86"	N.A.	ZJT888CT	\$112

Change-of-Height Frame Kits

45"	65"	65"	N.A.	ZJT466CT	\$ 97
45"	86"	86"	N.A.	ZJT488CT	\$107
65"	86"	86"	N.A.	ZJT688CT	\$122
65"	45"	45"	N.A.	ZJT644CT	\$ 97
86"	45"	45"	N.A.	ZJT844CT	\$107
86"	65"	65"	N.A.	ZJT866CT	\$122

► **Specification Information, continued on next page**

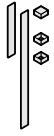

Tip: Brackets are for use with frames that have lay-in cable tracks mounted to them.

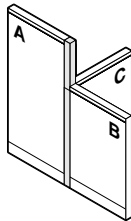
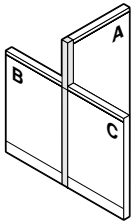
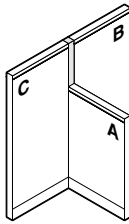
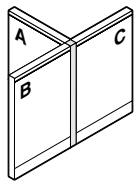

Lay-In Cable Track and Junctions, continued

SIN 711.1

► Specification Information, continued

Specification Information

Dimensions				Style Number	Price
A	B	C	D		

Frame Junction Kits For Use with Frames with a Lay-In Cable Track, continued

X-Junctions

Same-Height Frame Kits

45"	45"	45"	45"	ZJX4444CT	\$ 87
65"	65"	65"	65"	ZJX6666CT	\$ 97
86"	86"	86"	86"	ZJX8888CT	\$112

Change-of-Height Frame Kits

45"	65"	45"	65"	ZJX4646CT	\$ 97
45"	86"	45"	86"	ZJX4848CT	\$107
65"	86"	65"	86"	ZJX6868CT	\$122

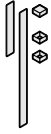

Tip: Brackets are for use with frames that have lay-in cable tracks mounted to them.

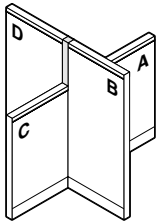
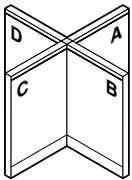

Tip: Brackets are for use with frames that have lay-in cable tracks mounted to them.

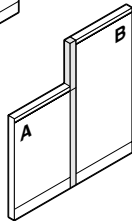
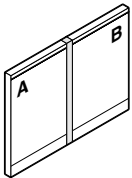

I-Junctions

Same-Height Frame Kits

45"	45"	N.A.	N.A.	ZJI44CT	\$ 87
65"	65"	N.A.	N.A.	ZJI66CT	\$ 97
86"	86"	N.A.	N.A.	ZJI88CT	\$112

Change-of-Height Frame Kits

45"	65"	N.A.	N.A.	ZJI46CT	\$ 97
45"	86"	N.A.	N.A.	ZJI48CT	\$107
65"	86"	N.A.	N.A.	ZJI68CT	\$122

Frame Junction Kits

For Use with Frames with a Lay-In Cable Track Joining to Frames with No Lay-In Track

Standard Includes	Required to Specify
<ul style="list-style-type: none"> • Top cap: all paint price groups • Connectors • Square cover: all paint price groups • End trim, if applicable: all paint price groups 	<ul style="list-style-type: none"> 1 Style number 2 Paint color number for top cap, square cover, and end trim ▶ See <i>Surface Materials</i>, page C252.

Tip: Brackets are for use with frames that have lay-in cable tracks mounted to them.

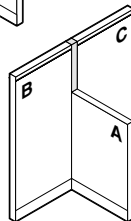
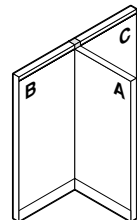
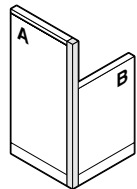
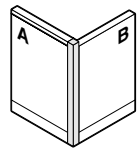

Specification Information

Dimensions				Style	Price
A	B	C	D	Number	

Square L-Junctions, Lay-In One Side Only

Same-Height Frame Kits

45"	45"	N.A.	N.A.	ZJL44SCT1	\$ 87
65"	65"	N.A.	N.A.	ZJL66SCT1	\$ 97
86"	86"	N.A.	N.A.	ZJL88SCT1	\$112

Square L-Junctions, Lay-In on 65" or 86"

Change-of-Height Frame Kits

45"	65"	N.A.	N.A.	ZJL46SCT1	\$ 97
45"	86"	N.A.	N.A.	ZJL48SCT1	\$107
65"	86"	N.A.	N.A.	ZJL68SCT1	\$122

T-Junctions, Lay-In on Two Parallel Frames Only

Same-Height Frame Kits

45"	45"	45"	N.A.	ZJT444CT2	\$ 87
65"	65"	65"	N.A.	ZJT666CT2	\$ 97
86"	86"	86"	N.A.	ZJT888CT2	\$112

Change-of-Height Frame Kits

45"	65"	65"	N.A.	ZJT466CT2	\$ 97
45"	86"	86"	N.A.	ZJT488CT2	\$107
65"	86"	86"	N.A.	ZJT688CT2	\$122

Lay-In Cable Track and Junctions, continued

SIN 711.1

Frame Junction Kits, continued

For Use with Frames with a Lay-In Cable Track Joining to Frames with No Lay-In Track

Standard Includes	Required to Specify
<ul style="list-style-type: none"> • Top cap: all paint price groups • Connectors • Square cover: all paint price groups • End trim, if applicable: all paint price groups 	<ul style="list-style-type: none"> 1 Style number 2 Paint color number for top cap, square cover, and end trim ▶ See <i>Surface Materials</i>, page C252.

Tip: Brackets are for use with frames that have lay-in cable tracks mounted to them.

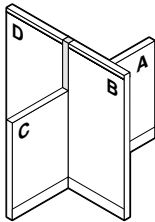
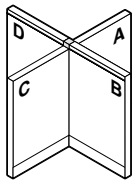

Tip: Lay-in cable track is on two 65" or 86" parallel frames only.

Specification Information					
• Dimensions				• Style	• Price
A	B	C	D	Number	

X-Junctions, Lay-In on Two Parallel Frames Only

Same-Height Frame Kits

45"	45"	45"	45"	ZJX4444CT2	\$ 87
65"	65"	65"	65"	ZJX6666CT2	\$ 97
86"	86"	86"	86"	ZJX8888CT2	\$112

Change-of-Height Frame Kits

45"	65"	45"	65"	ZJX4646CT2	\$ 97
45"	86"	45"	86"	ZJX4848CT2	\$107
65"	86"	65"	86"	ZJX6868CT2	\$122

End Trim

For Use with Frames with a Lay-In Cable Track

Standard Includes	Required to Specify
<ul style="list-style-type: none"> • Vertical end trim: all paint price groups • Connectors 	<ul style="list-style-type: none"> 1 Style number 2 Paint color number for end trim and connectors ▶ See <i>Surface Materials</i>, page C252.

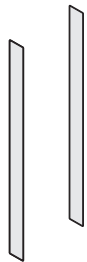

Tip: Trim piece is approximately 2" taller than frame and or stacker frame it is mounted to.

Specification Information		
• Height	• Style Number	• Price
22"	ZET22	\$24
42"	ZET42	\$36
47"	ZET47	\$38
67"	ZET67	\$47
88"	ZET88	\$57

SIN 711.1

Power Modules

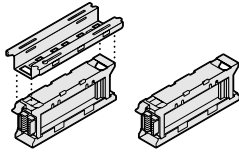

Tip: Remember to specify Internode receptacles separately.
▶ Pages C106–C107

Tip: Internode works with powerkit system only.

Standard Includes	Required to Specify
<ul style="list-style-type: none"> Power block and enclosing housing: 4793 Solar Black only Four modular receptacle attachment points Mounting bracket, if selected: 6653 Solar Black only Two covers: 6653 Solar Black only 	<ul style="list-style-type: none"> Style number

Related Products
<ul style="list-style-type: none"> Internode mounting bracket ▶ Page C96 Receptacles ▶ Pages C106–C107

Specification Information

Dimensions			Includes Mounting Bracket	Style Number	Price
D	W	H			
4-Circuit, 3+1					
3"	10"	3½"	Yes	GFUPMBX	\$203
3"	10"	3½"	No	GFUPMX	\$176
For Use in New York City					
3"	10"	3½"	Yes	GFUPMBXNYC	\$203
3"	10"	3½"	No	GFUPMXNYC	\$176
4-Circuit, 2+2					
3"	10"	3½"	Yes	GFUPMBY	\$203
3"	10"	3½"	No	GFUPMY	\$176
For Use in New York City					
3"	10"	3½"	Yes	GFUPMBYNYC	\$203
3"	10"	3½"	No	GFUPMYNYC	\$176
3-Circuit, Separate Neutrals					
3"	10"	3½"	Yes	GFUPMBZ	\$203
3"	10"	3½"	No	GFUPMZ	\$176
For Use in New York City					
3"	10"	3½"	Yes	GFUPMBZNYC	\$203
3"	10"	3½"	No	GFUPMZNYC	\$176

Montage

Internode Power and Communication Components, continued

SIN 711.1

Communication Module

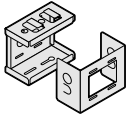

Tip: Communication modules can be supported by mounting bracket, power module, or applied directly to the underside of a worksurface.

Tip: Internode works with powerkit system only.

Standard Includes	Required to Specify
<ul style="list-style-type: none"> Two-piece communication module: 4793 Solar Black only One cover, used to adapt NEMA opening to modular furniture faceplate opening 	Style number

Specification Information				
• Dimensions			• Style	• Price
D	W	H	Number	
3"	5"	4"	GFUSCM	\$41
:	:	:	:	:

Mounting Bracket

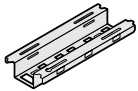

Tip: Mounting bracket supports either a communication module or a power module.

Tip: Internode works with powerkit system only.

Standard Includes	Required to Specify
<ul style="list-style-type: none"> Mounting bracket: 4793 Solar Black only 	Style number

Specification Information	
• Style	• Price
Number	
GFUMB	\$27
:	:

Internode Cord and Cable Manager

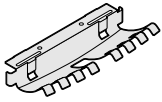

Tip: Internode works with powerkit system only.

Standard Includes	Required to Specify
-------------------	---------------------

- Cord and cable manager: 6653 Solar Black only
- Package of four

Style number

Specification Information				
• Dimensions			• Style	• Price
D	W	H	Number	

3½"	10"	1¼"	GFUCCM	\$81
-----	-----	-----	---------------	------

Internode Harness Clips



Tip: Internode works with powerkit system only.

Standard Includes	Required to Specify
-------------------	---------------------

- Package of 25 harness clips with screws: black only

Style number

Specification Information		
• Diameter	• Style	• Price
	Number	

1¼"	GFUCMC	\$27
-----	---------------	------

Montage

SIN 711.1

Convenience Tri-Receptacles with Modular Harness

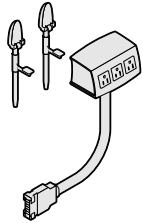

Tip: Internode works with powerkit system only.

Standard Includes	Required to Specify
<ul style="list-style-type: none"> • Convenience tri-receptacle with three outlets: plastic • Harness with modular connector for attachment to end of power module • Conduit: metallic • Mounting clamp kit 	<ul style="list-style-type: none"> 1 Style number 2 Plastic color number for receptacle 3 Options, if selected (see below) ▶ See <i>Surface Materials</i>, page C252.

Options	Price	Required to Specify
Outfeed <ul style="list-style-type: none"> • Powerkit receptacle opening 	+\$21	Specify with beltway power outfeed connector.

Specification Information

• Harness Length	• Line	• Style Number	• Base Price	• Style Number	• Base Price
------------------	--------	----------------	--------------	----------------	--------------

4-Circuit, 3+1

With System Ground				With Isolated Ground	
72"	Line 1	GFUT1S72X	\$149	GFUT1G72X	\$149
	Line 2	GFUT2S72X	\$149	GFUT2G72X	\$149
	Line 3	GFUT3S72X	\$149	GFUT3G72X	\$149
	Line 4	GFUT4S72X	\$149	GFUT4G72X	\$149

4-Circuit, 2+2

With System Ground				With Isolated Ground	
72"	Line 1	GFUT1S72Y	\$149	GFUT1G72Y	\$149
	Line 2	GFUT2S72Y	\$149	GFUT2G72Y	\$149
	Line 3	GFUT3S72Y	\$149	GFUT3G72Y	\$149
	Line 4	GFUT4S72Y	\$149	GFUT4G72Y	\$149

3-Circuit, Separate Neutrals

With System Ground				With Isolated Ground	
72"	Line 1	GFUT1S72Z	\$149	GFUT1G72Z	\$149
	Line 2	GFUT2S72Z	\$149	GFUT2G72Z	\$149
	Line 3	GFUT3S72Z	\$149	GFUT3G72Z	\$149

Convenience Tri-Receptacles with Power Cord and Plug



Tip: This unit does not include clamp kit.
▶ Page C100

Tip: Internode works with powerkit system only.

Standard Includes	Required to Specify
-------------------	---------------------

- Convenience receptacle with three outlets: plastic
- 96" power cord with grounded plug: black only

- 1 Style number
- 2 Plastic color number for receptacle
- ▶ See *Surface Materials*, page C252.

Related Products

- Above-worksurface clamp kit
- Below-worksurface mounting bracket

- ▶ Page C100
- ▶ Page C100

Specification Information				
• Dimensions			• Style	• Price
D	W	H	Number	

2¾"	5¼"	2½"	GFUTP96	\$81
-----	-----	-----	----------------	------

Convenience Communication Outlet Housing



Tip: This unit does not include clamp kit.
▶ Page C100

Tip: Communications convenience receptacle housing can be connected to convenience tri-receptacles side by side.

Tip: Internode works with powerkit system only.

Standard Includes	Required to Specify
-------------------	---------------------

- Housing for field-installed modular communications faceplate: plastic

- 1 Style number
- 2 Plastic color number for housing
- ▶ See *Surface Materials*, page C252.

Related Products

- Above-worksurface clamp kit
- Below-worksurface mounting bracket

- ▶ Page C100
- ▶ Page C100

Specification Information				
• Dimensions			• Style	• Price
D	W	H	Number	

2¾"	5¼"	2½"	GFUCH	\$41
-----	-----	-----	--------------	------

Internode Power and Communication Components, continued

SIN 711.1

Above-Worksurface Clamp Kit

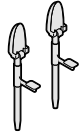

Tip: Internode works with powerkit system only.

Standard Includes	Required to Specify
<ul style="list-style-type: none"> • Mounting clamp to secure convenience receptacle to worksurface: 6653 Solar Black only 	Style number

Related Products
<ul style="list-style-type: none"> • Convenience tri-receptacles with modular harness ▶ Page C98 • Convenience tri-receptacles with power cord and plug ▶ Page C99 • Convenience communication outlet housing ▶ Page C99

Specification Information	
• Style Number	• Price
GFUTMC	\$14
•	•

Below-Worksurface Mounting Bracket

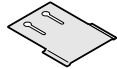

Tip: Mounting bracket supports convenience receptacles and communications outlet housing below the worksurface.

Tip: Each tri-receptacle, whether power or communications, should have its own mounting bracket for below-worksurface mounting applications.

Tip: Internode works with powerkit system only.

Standard Includes	Required to Specify
<ul style="list-style-type: none"> • Mounting bracket: 4793 Solar Black only 	Style number

Related Products
<ul style="list-style-type: none"> • Convenience tri-receptacles with modular harness ▶ Page C98 • Convenience tri-receptacles with power cord and plug ▶ Page C99 • Convenience communication outlet housing ▶ Page C99

Specification Information	
• Style Number	• Price
GFUTMB	\$10
•	•

Internode Power Outfeed

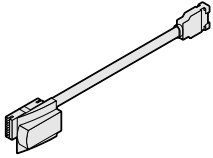

Tip: Power outfeed cover and tri-receptacle are always the same color.

Tip: Internode works with powerkit system only.

Standard Includes	Required to Specify
<ul style="list-style-type: none"> • 72" harness: metallic • Modular connector to attach to receptacle location in powerkit: plastic • Modular connector to attach to power module 	1 Style number 2 Plastic color number for modular connector ▶ See <i>Surface Materials</i> , page C252.

Specification Information

Style Number	Price
4-Circuit, 3+1	
GFUBFM6X	\$189
4-Circuit, 2+2	
GFUBFM6Y	\$189
3-Circuit, Separate Neutrals	
GFUBFM6Z	\$189

Montage

SIN 711.1

Modular Harnesses

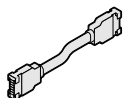

Tip: Internode works with powerkit system only.

Standard Includes	Required to Specify
• Harness	Style number

Specification Information

Length	Style Number	Price
--------	--------------	-------

4-Circuit, 3+1

11"	GSGUH11X	\$ 95
12"	GSGUH12X	\$ 95
22"	GSGUH22X	\$ 95
28"	GSGUH28X	\$ 95
32"	GSGUH32X	\$ 95
38"	GSGUH38X	\$ 95
44"	GSGUH44X	\$108
50"	GSGUH50X	\$108
54"	GSGUH54X	\$108
64"	GSGUH64X	\$122
76"	GSGUH76X	\$135
88"	GSGUH88X	\$149
100"	GSGUH100X	\$162
120"	GSGUH120X	\$189
144"	GSGUH144X	\$216
:	:	:

4-Circuit, 2+2

11"	GSGUH11Y	\$ 95
12"	GSGUH12Y	\$ 95
22"	GSGUH22Y	\$ 95
28"	GSGUH28Y	\$ 95
32"	GSGUH32Y	\$ 95
38"	GSGUH38Y	\$ 95
44"	GSGUH44Y	\$108
:	:	:

Specification Information

Length	Style Number	Price
--------	--------------	-------

4-Circuit, 2+2, continued

50"	GSGUH50Y	\$108
54"	GSGUH54Y	\$108
64"	GSGUH64Y	\$122
76"	GSGUH76Y	\$135
88"	GSGUH88Y	\$149
100"	GSGUH100Y	\$162
120"	GSGUH120Y	\$189
144"	GSGUH144Y	\$216
:	:	:

3-Circuit, Separate Neutrals

11"	GSGUH11Z	\$ 95
12"	GSGUH12Z	\$ 95
22"	GSGUH22Z	\$ 95
28"	GSGUH28Z	\$ 95
32"	GSGUH32Z	\$ 95
38"	GSGUH38Z	\$ 95
44"	GSGUH44Z	\$108
50"	GSGUH50Z	\$108
54"	GSGUH54Z	\$108
64"	GSGUH64Z	\$122
76"	GSGUH76Z	\$135
88"	GSGUH88Z	\$149
100"	GSGUH100Z	\$162
120"	GSGUH120Z	\$189
144"	GSGUH144Z	\$216
:	:	:



SIN 711.1

Internode Floor Power Infeeds

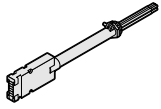

Tip: Floor power infeed cannot be used in New York City. Use a multipurpose power infeed instead.

Tip: Internode works with powerkit system only.

Standard Includes	Required to Specify
<ul style="list-style-type: none"> • Junction box fittings for hardwired connection • Liquid-tight flexible conduit: black vinyl 	Style number

Specification Information

Length	Style Number	Price
4-Circuit, 3+1		
6'	GFUFFH6X	\$162
12'	GFUFFH12X	\$216
·	·	·
4-Circuit, 2+2		
6'	GFUFFH6Y	\$162
12'	GFUFFH12Y	\$216
·	·	·
3-Circuit, Separate Neutrals		
6'	GFUFFH6Z	\$162
12'	GFUFFH12Z	\$216
·	·	·

Multipurpose Power Infeeds

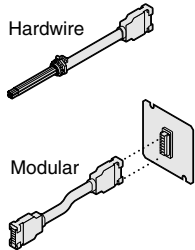

Tip: Modular connector receptacle covers a standard 4⁹/₁₆" square junction box.

Tip: Remember to specify utility pole.
 ▶ See Montage Solutions Specification Guide.

Tip: Municipal building codes vary. Review installation requirements with local inspector prior to installation to ensure all guidelines are met.

Tip: Internode works with powerkit system only.

Standard Includes	Required to Specify
<ul style="list-style-type: none"> • Junction box fittings for hardwired connection, if selected • Modular connector, if selected • Modular connector receptacle included with modular option • Conduit: metal 	Style number

Specification Information

Length and Connection	Style Number	Price
-----------------------	--------------	-------

4-Circuit, 3+1

12' Hardwire	GSGUFMH12X	\$243
12' Modular	GSGUFMM12X	\$311
24' Hardwire	GSGUFMH24X	\$352
24' Modular	GSGUFMM24X	\$419
:	:	:

4-Circuit, 2+2

12' Hardwire	GSGUFMH12Y	\$243
12' Modular	GSGUFMM12Y	\$311
24' Hardwire	GSGUFMH24Y	\$352
24' Modular	GSGUFMM24Y	\$419
:	:	:

3-Circuit, Separate Neutrals

12' Hardwire	GSGUFMH12Z	\$243
12' Modular	GSGUFMM12Z	\$311
24' Hardwire	GSGUFMH24Z	\$352
24' Modular	GSGUFMM24Z	\$419
:	:	:

Montage

SIN 711.1

15-Amp Internode Receptacles

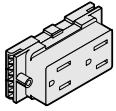

Tip: Receptacles are specified individually so you can order exactly the quantity you need.

Standard Includes	Required to Specify
<ul style="list-style-type: none"> Individual receptacles: plastic 	<ul style="list-style-type: none"> 1 Style number 2 Plastic color number for receptacles ▶ See <i>Surface Materials</i>, page C252.

Specification Information

Line	Style Number	Price	Style Number	Price
------	--------------	-------	--------------	-------

4-Circuit, 3+1

System Ground			Isolated Ground	
Line 1	GSGUR1SSX	\$32	GSGUR1SGX	\$41
Line 2	GSGUR2SSX	\$32	GSGUR2SGX	\$41
Line 3	GSGUR3SSX	\$32	GSGUR3SGX	\$41
Line 4	GSGUR4SSX	\$32	GSGUR4SGX	\$41
:	:	:	:	:

4-Circuit, 2+2

System Ground			Isolated Ground	
Line 1	GSGUR1SSY	\$32	GSGUR1SGY	\$41
Line 2	GSGUR2SSY	\$32	GSGUR2SGY	\$41
Line 3	GSGUR3SSY	\$32	GSGUR3SGY	\$41
Line 4	GSGUR4SSY	\$32	GSGUR4SGY	\$41
:	:	:	:	:

3-Circuit, Separate Neutrals

System Ground			Isolated Ground	
Line 1	GSGUR1SSZ	\$32	GSGUR1SGZ	\$41
Line 2	GSGUR2SSZ	\$32	GSGUR2SGZ	\$41
Line 3	GSGUR3SSZ	\$32	GSGUR3SGZ	\$41
:	:	:	:	:

20-Amp Internode Receptacles

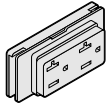

Tip: Receptacles are specified individually so you can order exactly the quantity you need.

Standard Includes	Required to Specify
<ul style="list-style-type: none"> Individual receptacles: plastic 	<ul style="list-style-type: none"> 1 Style number 2 Plastic color number for receptacles ▶ See <i>Surface Materials</i>, page C252.

Specification Information

Line	Style Number	Price	Style Number	Price
:	:	:	:	:

4-Circuit, 3+1

System Ground			Isolated Ground	
Line 1	GSGUR1TSX	\$49	GSGUR1TGX	\$62
Line 2	GSGUR2TSX	\$49	GSGUR2TGX	\$62
Line 3	GSGUR3TSX	\$49	GSGUR3TGX	\$62
Line 4	GSGUR4TSX	\$49	GSGUR4TGX	\$62
:	:	:	:	:

4-Circuit, 2+2

System Ground			Isolated Ground	
Line 1	GSGUR1TSY	\$49	GSGUR1TGY	\$62
Line 2	GSGUR2TSY	\$49	GSGUR2TGY	\$62
Line 3	GSGUR3TSY	\$49	GSGUR3TGY	\$62
Line 4	GSGUR4TSY	\$49	GSGUR4TGY	\$62
:	:	:	:	:

3-Circuit, Separate Neutrals

System Ground			Isolated Ground	
Line 1	GSGUR1TSZ	\$49	GSGUR1TGZ	\$62
Line 2	GSGUR2TSZ	\$49	GSGUR2TGZ	\$62
Line 3	GSGUR3TSZ	\$49	GSGUR3TGZ	\$62
:	:	:	:	:

Specifying Montage Tiles

► For more detailed product information, see the *Montage Solutions Specification Guide* or consult your Steelcase dealer.

Tiles

Enhanced Tackable Acoustical Tiles (SIN 711.1)	C110
Enhanced High-Performance Acoustical Tiles (SIN 711.1)	C111
Enhanced Non-Tackable Tiles (SIN 711.1)	C112
Enhanced Galvanized Tiles (SIN 711.1)	C114
Enhanced Laminate Tiles (SIN 711.1)	C115
Enhanced Wood Tiles (SIN 711.1)	C116
Enhanced Markerboard Tiles (SIN 711.1)	C117
Enhanced Slatwall Tiles (SIN 711.1)	C118
Enhanced Glass Tile Packages (SIN 711.1)	C119
Enhanced Consolidation Point Locking Door Tiles (SIN 711.1)	C120
Tile Accessories (SIN 711.1)	C121

Enhanced Tackable Acoustical Tiles

SIN 711.1

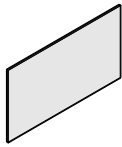

Tip: Standard warp direction on fabric-wrapped tiles is warp horizontal.

Standard Includes	Required to Specify
-------------------	---------------------

- | | |
|--|--|
| Standard Includes | Required to Specify |
| <ul style="list-style-type: none"> Tile: fabric price group 1 | <ol style="list-style-type: none"> Style number Fabric color number for tile surface Options, if selected (see below) <p>▶ See <i>Surface Materials</i>, page C252.</p> |

Surface Materials	Options	Price	Required to Specify
-------------------	---------	-------	---------------------

Surface Materials	Options	Price	Required to Specify
	<ul style="list-style-type: none"> Fabric price group 1 Fabric price group 2 Fabric price group 3 Fabric price group 4 Fabric price group 5 Fabric price group COM 	<p>No cost</p> <p>+\$13</p> <p>+\$22</p> <p>+\$32</p> <p>+\$50</p> <p>+\$15</p>	<p>Specify fabric color number.</p> <p>Specify fabric color number.</p> <p>Specify fabric color number.</p> <p>Specify fabric color number.</p> <p>Specify fabric color number.</p> <p>▶ See <i>Surface Materials Reference Manual</i> to specify.</p>

Fabric direction	Price	Required to Specify
------------------	-------	---------------------

- | | | |
|--|---------|-----------------------------|
| Fabric direction | Price | Required to Specify |
| <ul style="list-style-type: none"> Warp vertical on directional fabrics | No cost | Specify with warp vertical. |

Specification Information		
Width	Style Number	Base Price

Width	Style Number	Base Price

13"H Tiles

24"	ZTAE2413	\$ 70
30"	ZTAE3013	\$ 85
36"	ZTAE3613	\$100
42"	ZTAE4213	\$115
48"	ZTAE4813	\$130

20"H Tiles

24"	ZTAE2420	\$ 80
30"	ZTAE3020	\$ 95
36"	ZTAE3620	\$110
42"	ZTAE4220	\$125
48"	ZTAE4820	\$140

Enhanced High-Performance Acoustical Tiles

SIN 711.1

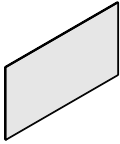

Tip: Standard warp direction on fabric-wrapped tiles is warp horizontal.

Standard Includes	Required to Specify
-------------------	---------------------

- | | |
|---|--|
| Standard Includes | Required to Specify |
| <ul style="list-style-type: none"> Tile: vertical surface fabric price group 1 | <ol style="list-style-type: none"> Style number Fabric color number for tile surface Options, if selected (see below) <p>▶ See <i>Surface Materials</i>, page C252.</p> |

Options	Price	Required to Specify
---------	-------	---------------------

Options	Price	Required to Specify
Surface Materials <ul style="list-style-type: none"> Fabric price group 1 Fabric price group 2 Fabric price group 3 Fabric price group 4 Fabric price group 5 Fabric price group COM 	No cost +\$13 +\$22 +\$32 +\$50 +\$15	Specify fabric color number. Specify fabric color number. Specify fabric color number. Specify fabric color number. Specify fabric color number. ▶ See <i>Surface Materials Reference Manual</i> to specify.

Fabric direction	Price	Required to Specify
<ul style="list-style-type: none"> Warp vertical on directional fabrics 	No cost	Specify with warp vertical.

Specification Information		
Width	Style Number	Base Price

13"H Tiles

Width	Style Number	Base Price
24"	ZTHE2413	\$ 61
30"	ZTHE3013	\$ 73
36"	ZTHE3613	\$ 86
42"	ZTHE4213	\$ 98
48"	ZTHE4813	\$110
:	:	:

20"H Tiles

Width	Style Number	Base Price
24"	ZTHE2420	\$ 87
30"	ZTHE3020	\$100
36"	ZTHE3620	\$113
42"	ZTHE4220	\$126
48"	ZTHE4820	\$140
:	:	:

Montage

Enhanced Non-Tackable Tiles

SIN 711.1

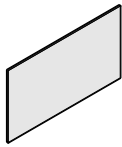

Tip: Standard warp direction on fabric-wrapped tiles is warp horizontal.

Tip: Perforated, indented, and dome tile pattern options are not available on fabric-covered tiles. Pattern options are not available on tiles with cutout and base fiber-in.

Tip: Perforated tiles ship with metal septum, which will block cable and power routing when used back-to-back.

Tip: Dome tiles cannot be used behind off-module bracket connections.

Decoding pattern numbers

P= Perforated
I = Indented
D= Dome

Number indicates the quantity of holes or indentations in a 2"W x 1 3/8"H area.

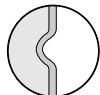

Cross-section through indented tile

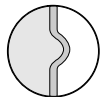

Cross-section through dome tile

Standard Includes		Required to Specify	
	<ul style="list-style-type: none"> Tile: paint price group 1 Wedge-shaped connector, if applicable: black plastic only 6'-long, 3/4" inside diameter conduit, on base fiber-in only: black plastic only 		<ul style="list-style-type: none"> 1 Style number 2 Paint color number for tile surface 3 Options, if selected (see below) <p>▶ See <i>Surface Materials</i>, page C252.</p>
Options		Price	Required to Specify
Surface Materials	<ul style="list-style-type: none"> Paint price group 1 Paint price group 2 Paint price group 3 	<ul style="list-style-type: none"> No cost +\$ 6 +\$ 10 	<ul style="list-style-type: none"> Specify paint color number. Specify paint color number. Specify paint color number.
	<ul style="list-style-type: none"> Fabric price group 1 Fabric price group 2 Fabric price group 3 Fabric price group 4 Fabric price group 5 Fabric price group COM 	<ul style="list-style-type: none"> No cost +\$ 13 +\$ 22 +\$ 32 +\$ 50 +\$ 15 	<ul style="list-style-type: none"> Specify fabric color number. Specify fabric color number. Specify fabric color number. Specify fabric color number. Specify fabric color number. <p>▶ See <i>Surface Materials Reference Manual</i> to specify.</p>
	Fabric direction		
	<ul style="list-style-type: none"> Warp vertical on directional fabrics 	No cost	Specify with warp vertical.

Metal Tile Patterns	Patterned 20"H tiles	Price	Required to Specify
		<ul style="list-style-type: none"> 24"W 30"W 36"W 42"W 48"W 	<ul style="list-style-type: none"> +\$ 88 +\$108 +\$118 +\$130 +\$142

Metal Tile Patterns



P4, I4, D4

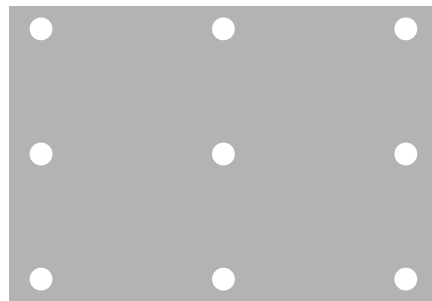

P9, I9, D9

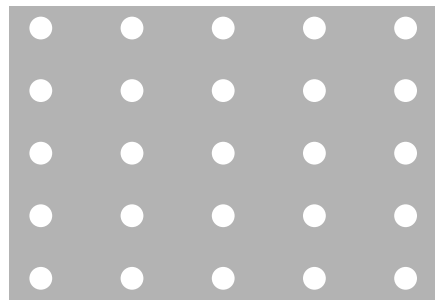

P20

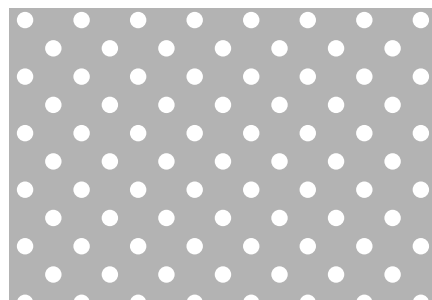

P85

Specification Information

Width	Style Number	Base Price
-------	--------------	------------

13"H Tiles

24"	ZTSE2413	\$ 41
30"	ZTSE3013	\$ 47
36"	ZTSE3613	\$ 52
42"	ZTSE4213	\$ 58
48"	ZTSE4813	\$ 64

20"H Tiles

24"	ZTSE2420	\$ 43
30"	ZTSE3020	\$ 49
36"	ZTSE3620	\$ 54
42"	ZTSE4220	\$ 60
48"	ZTSE4820	\$ 66

20"H Tiles with Cutout and Base Fiber-In

24"	ZTFE2420	\$120
30"	ZTFE3020	\$127
36"	ZTFE3620	\$134
42"	ZTFE4220	\$141
48"	ZTFE4820	\$148

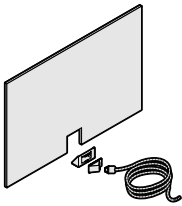

Tip: Tile with opening only, without connector or conduit, is available as a customer service part. Contact your Steelcase representative.

Tip: Patterned tiles are not available on base fiber-in tiles.

Enhanced Galvanized Tiles

SIN 711.1

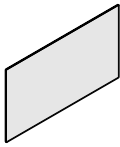

Tip: Galvanized metal is a random, patterned, and decorative material. Expect this material to vary in color, color consistency, and pattern density.

Tip: Perforated galvanized tiles ship with metal septum, which will block cable and power routing when used back-to-back.

Standard Includes	Required to Specify
-------------------	---------------------

- | | |
|--|--|
| <ul style="list-style-type: none"> Tile: galvanized metal (forced finish) | 1 Style number
2 Options, if selected (see below) |
|--|--|

Options	Price	Required to Specify
---------	-------	---------------------

Metal Tile Patterns	Perforated, indented, or dome on 13"H and 20"H tiles	Required to Specify
<ul style="list-style-type: none"> 24"W 30"W 36"W 42"W 48"W 	<ul style="list-style-type: none"> +\$ 88 +\$108 +\$118 +\$130 +\$142 	Specify tile pattern number. Specify tile pattern number. Specify tile pattern number. Specify tile pattern number. Specify tile pattern number.

Specification Information				
Width	Style Number	Base Price	Style Number	Base Price

13"H Tiles			20"H Tiles	
24"	ZTVE2413	\$43	ZTVE2420	\$45
30"	ZTVE3013	\$49	ZTVE3020	\$51
36"	ZTVE3613	\$54	ZTVE3620	\$56
42"	ZTVE4213	\$60	ZTVE4220	\$62
48"	ZTVE4813	\$66	ZTVE4820	\$68

Metal Tile Patterns

Decoding pattern numbers

P = Perforated
 I = Indented
 D = Dome
 Number indicates the quantity of holes or indentations in a 2"W x 1 3/8"H area.



Cross-section through indented tile



Cross-section through dome tile



P4, I4, D4

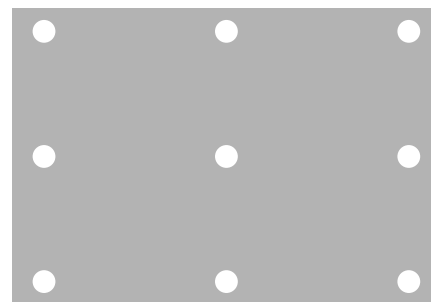

P9, I9, D9

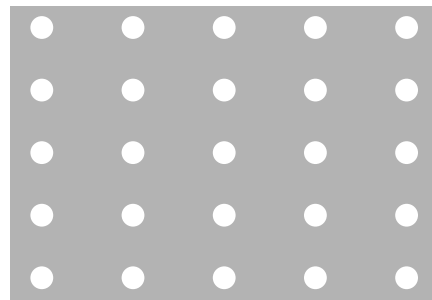

P20

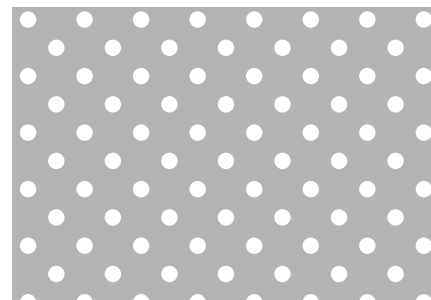

P85

Enhanced Laminate Tiles

SIN 711.1

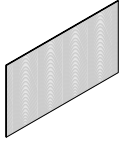

Standard Includes	Required to Specify
<ul style="list-style-type: none"> Tile: laminate 	1 Style number 2 Laminate color number for tile surface 3 Options, if selected (see below) ▶ See <i>Surface Materials</i> , page C252.

Options	Price	Required to Specify
Surface Materials <ul style="list-style-type: none"> Open line laminate 	+\$60 plus cost of laminate	▶ See <i>Surface Materials Reference Manual</i> to specify.

Specification Information

Width	Style Number	Base Price

13"H Tiles

24"	ZTLE2413	\$ 80
30"	ZTLE3013	\$ 95
36"	ZTLE3613	\$110
42"	ZTLE4213	\$125
48"	ZTLE4813	\$140
:	:	:

20"H Tiles

24"	ZTLE2420	\$ 85
30"	ZTLE3020	\$100
36"	ZTLE3620	\$115
42"	ZTLE4220	\$130
48"	ZTLE4820	\$145
:	:	:



Enhanced Wood Tiles

SIN 711.1

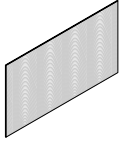

Standard Includes	Required to Specify
<ul style="list-style-type: none"> • Tile: wood 	1 Style number 2 Wood color number for tile surface 3 Options, if selected (see below) ▶ See <i>Surface Materials</i> , page C252.

Options	Price	Required to Specify
Surface Materials <ul style="list-style-type: none"> • Customiz stain on wood 	Prices below	Specify <i>with Customiz stain</i> . ▶ See <i>Surface Materials Reference Manual</i> .

Specification Information			
Width	Style Number	Base Price	Option
:	:	:	(Add \$ to Base Price)
:	:	:	Customiz Stain

13"H Tiles

24"	ZTWE2413	\$150	+\$24
30"	ZTWE3013	\$168	+\$24
36"	ZTWE3613	\$188	+\$24
42"	ZTWE4213	\$206	+\$24
48"	ZTWE4813	\$225	+\$24
:	:	:	:

20"H Tiles

24"	ZTWE2420	\$170	+\$24
30"	ZTWE3020	\$194	+\$24
36"	ZTWE3620	\$216	+\$24
42"	ZTWE4220	\$239	+\$24
48"	ZTWE4820	\$261	+\$41
:	:	:	:

Enhanced Markerboard Tiles

SIN 711.1

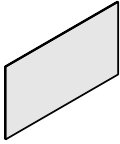

Tip: For 13"H application use slatwall with Details markerboard.
 ▶ Page C118

Standard Includes	Required to Specify
<ul style="list-style-type: none"> Whiteboard surface tile for use with dry erase markers 	Style number

Specification Information

Width	Style Number	Price
:	:	:
:	:	:

20"H Tiles

24"	ZTME2420	\$105
30"	ZTME3020	\$120
36"	ZTME3620	\$135
42"	ZTME4220	\$150
48"	ZTME4820	\$165
:	:	:



Enhanced Slatwall Tiles

SIN 711.1

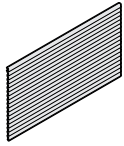

Standard Includes	Required to Specify
-------------------	---------------------

- Slatwall tile: paint price group 1

- 1 Style number
- 2 Paint color number for slatwall tile
- ▶ See *Surface Materials*, page C252.

Surface Materials	Options	Price	Required to Specify
-------------------	---------	-------	---------------------

Surface Materials	• Paint price group 1	No cost	Specify paint color number.
	• Paint price group 2	+\$ 6	Specify paint color number.
	• Paint price group 3	+\$10	Specify paint color number.

Specification Information		
Width	Style Number	Base Price

Width	Style Number	Base Price
-------	--------------	------------

13"H Tiles

24"	ZSWE2413	\$130
30"	ZSWE3013	\$145
36"	ZSWE3613	\$160
42"	ZSWE4213	\$175
48"	ZSWE4813	\$190

20"H Tiles

24"	ZSWE2420	\$145
30"	ZSWE3020	\$160
36"	ZSWE3620	\$170
42"	ZSWE4220	\$195
48"	ZSWE4820	\$205

Details Slatwall

Work Tools

Tip: Details worktools are available for use on Montage slatwall tiles.

Contact:

Details

6100 East Paris Avenue

5th Floor, Corporate

Development Center

Caledonia, MI 49316

Telephone 1.800.833.0411

Fax 1.256.230.6551

Tip: These Details slatwall work tools **cannot** be used on Montage work-tool-rail tiles specified prior to January 1997. And old Montage work-tool accessories **cannot** be used on the current slatwall tiles.

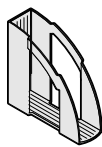

Binder Holder

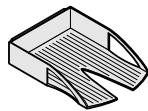

Letter Tray

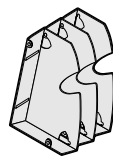

Universal Shelf

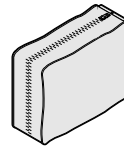

Side Access Folder

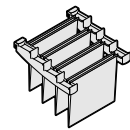

Hanging Brackets



Work Tag

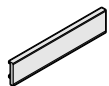

TackStrip

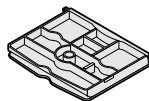

Office in a File

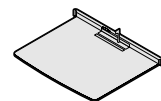

Workboard

Enhanced Glass Tile Packages

SIN 711.1

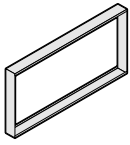

Tip: Frames with glass tile packages installed cannot support overhead storage components.

Tip: Glass tiles cannot be used at worksurface height in front of a worksurface.

Tip: Off-module frame connections over glass can only be accommodated on the top row of a panel that is 65"H or higher.

Standard Includes	Required to Specify
-------------------	---------------------

- Two transparent inserts: clear tempered glass
- Interior trim kit: plastic

- 1 Style number
 - 2 Plastic color number for interior trim kit
 - 3 Options, if selected (see below)
- ▶ See *Surface Materials*, page C252.

Options	Price	Required to Specify
---------	-------	---------------------

Glass Tile Patterns	• Frosted	+\$108	Specify with <i>Frosted Glass</i> pattern and select 6000 Black plastic or 6659 Light Grey plastic.
	• Rice Paper	+\$108	Specify with <i>Rice Paper</i> pattern and select 6000 Black plastic or 6659 Light Grey plastic.
	• Strep Negative	+\$108	Specify with <i>Strep Negative</i> pattern and select 6000 Black plastic or 6659 Light Grey plastic.
	• Pin Stripe	+\$108	Specify with <i>Pin Stripe</i> pattern and select 6000 Black plastic or 6659 Light Grey plastic.
Interior Trim Kit	<ul style="list-style-type: none"> • 6000 Black • 6659 Light Grey 	No cost +\$ 38	Specify with <i>6000 Black</i> . Specify with <i>6659 Light Grey</i> .

Specification Information

Width	Style Number	Base Price
-------	--------------	------------

20"H Tiles

24"	ZTGE2420	\$189
30"	ZTGE3020	\$212
36"	ZTGE3620	\$235
42"	ZTGE4220	\$259
48"	ZTGE4820	\$282
:	:	:

Glass Tile Patterns

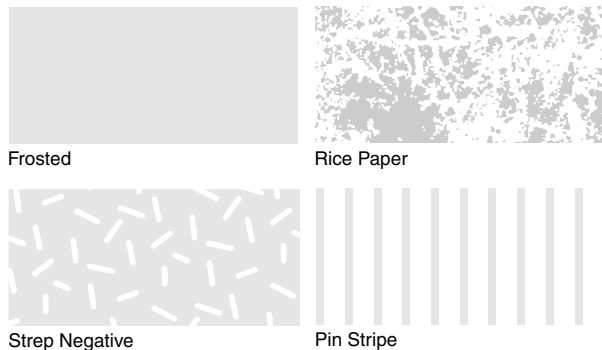

Frosted

Rice Paper

Strep Negative

Pin Stripe

Montage

Enhanced Consolidation Point Locking Door Tiles

SIN 711.1

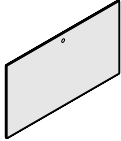

Tip: If locking is not required, a non-tackable tile can be used to cover a consolidation point.

Standard Includes	Required to Specify
-------------------	---------------------

- Tile: all paint price groups
- Lock, keyed random: 9201 Polished Chrome
- Mounting hardware

- 1 Style number
- 2 Paint color number for tile surface
- 3 Options, if selected (see below)
- ▶ See *Surface Materials*, page C252.

Surface Materials	Options	Price	Required to Specify
-------------------	---------	-------	---------------------

- | | | | |
|--------------------------|--------------------------|---------|---|
| Surface Materials | • Fabric price group 1 | No cost | Specify fabric color number.
Specify fabric color number.
Specify fabric color number.
Specify fabric color number.
Specify fabric color number.
▶ See <i>Surface Materials Reference Manual</i> to specify. |
| | • Fabric price group 2 | +\$13 | |
| | • Fabric price group 3 | +\$22 | |
| | • Fabric price group 4 | +\$32 | |
| | • Fabric price group 5 | +\$50 | |
| | • Fabric price group COM | +\$15 | |

- | | | |
|---------------|---------------------------------------|-------------|
| Keying | • Factory- and field-installed keying | ▶ Page C262 |
|---------------|---------------------------------------|-------------|

Specification Information

• Width	• Style Number	• Base Price

20"H Tiles

30"	ZCPSE30	\$145
36"	ZCPSE36	\$162
42"	ZCPSE42	\$179
48"	ZCPSE48	\$197

Tile Accessories

SIN 711.1

Enhanced Tile Removal Tool

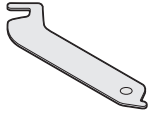

Standard Includes	Required to Specify
<ul style="list-style-type: none"> Enhanced tile removal tool 	Style number

Specification Information

Style Number	Price
ZFTE	\$15

Art Hook



Standard Includes	Required to Specify
<ul style="list-style-type: none"> Art hook: black paint only 	Style number

Specification Information

Dimensions		Style Number	Price
D	W		
1 ¹ / ₆₄ "	1 ⁵ / ₈ "	ZAAH	\$10

Montage

Specifying Montage Worksurfaces

► For more detailed product information, see the *Montage Solutions Specification Guide* or consult your Steelcase dealer.

Frame-Supported Worksurfaces

Straight Worksurfaces (SIN 711.1)	C124
Corner Worksurfaces (SIN 711.1)	C125
Extended Corner Worksurfaces (SIN 711.1)	C126
Extended Corner Cove Worksurfaces (SIN 711.1)	C128
Bubble Visitor Worksurfaces (SIN 711.1)	C129
Jetty Worksurfaces (SIN 711.1)	C130
Bubble Jetty Worksurfaces (SIN 711.1)	C131
Spanner and Fanned Spanner Worksurfaces (SIN 711.1)	C132
Straight Countertops (SIN 711.1)	C133
Corner Countertops (SIN 711.1)	C134

Worksurface Supports

Standard End Panels (SIN 711.1)	C136
Off-Module End Panels (SIN 711.1)	C137
Cantilevers (SIN 711.1)	C137
End-of-Run Cantilevers (SIN 711.1)	C138
Adjustable-Height Cantilevers (SIN 711.1)	C138
End Support Brackets (SIN 711.1)	C138
Off-Module Worksurface Bracket (SIN 711.1)	C139
Off-Module Tie Plate (SIN 711.1)	C139
Adjustable Column (SIN 711.1)	C139

Freestanding Worksurfaces

Adjustable-Height Worksurfaces with Crank (SIN 711.1)	C140
Adjustable-Height Extension Worksurfaces with Crank Adjustable (SIN 711.1)	C141
Adjustable-Height Worksurfaces with Electrically Adjustable Column Support (SIN 711.1)	C142

Worksurface Wiring and Cabling

C143

Straight Worksurfaces

SIN 711.1

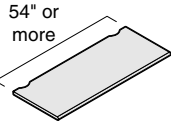
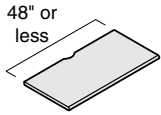

Tip: Worksurfaces with 60" or more of unsupported kneespace require additional cantilever support.
▶ See page C137 for cantilevers.

Tip: Pallets range between 10–25 worksurfaces.

Standard Includes	Required to Specify
<ul style="list-style-type: none"> • Worksurface: laminate • Worksurface edge: vinyl default sides and vinyl default torus edge on front • Cable scallops • Alignment plate package • Palletization of worksurfaces 	<ul style="list-style-type: none"> 1 Style number 2 Laminate color number for worksurface 3 Options, if selected (see below) ▶ See <i>Surface Materials</i>, page C252.

Options	Price	Required to Specify
Surface Materials <ul style="list-style-type: none"> • Open Line laminate 	+ \$60 plus cost of laminate	▶ See <i>Surface Materials Reference Manual</i> to specify.
Related Products <ul style="list-style-type: none"> • End panels • Off-module end panels • Cantilevers • End-of-run cantilevers • Side-support brackets • Off-module worksurface bracket • Off-module tie plate • Pedestals • Off-module pedestals 		<ul style="list-style-type: none"> ▶ Page C136 ▶ Page C137 ▶ Page C137 ▶ Page C138 ▶ Page C138 ▶ Page C139 ▶ Page C139 ▶ Page C163 ▶ Page C164

Specification Information

Dimensions	Style Number	Base Price
D	W	Price

24"D Worksurfaces

24"	24"	ZST2424	\$230
24"	30"	ZST2430	\$236
24"	36"	ZST2436	\$240
24"	42"	ZST2442	\$265
24"	48"	ZST2448	\$289
24"	54"	ZST2454	\$322
24"	60"	ZST2460	\$354
24"	66"	ZST2466	\$386
24"	72"	ZST2472	\$418

30"D Worksurfaces

30"	24"	ZST3024	\$237
30"	30"	ZST3030	\$242
30"	36"	ZST3036	\$246
30"	42"	ZST3042	\$273
30"	48"	ZST3048	\$296
30"	54"	ZST3054	\$330
30"	60"	ZST3060	\$363
30"	66"	ZST3066	\$399
30"	72"	ZST3072	\$430

Corner Worksurfaces

SIN 711.1

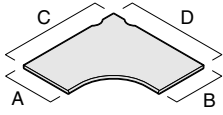

Tip: Pallets range between 10–25 worksurfaces.

Standard Includes	Required to Specify
<ul style="list-style-type: none"> • Worksurface: laminate • Worksurface edge: vinyl default sides and vinyl default torus edge on front • Cable scallops • Alignment plate package • Palletization of worksurfaces 	<ul style="list-style-type: none"> 1 Style number 2 Laminate color number for worksurface 3 Options, if selected (see below) ▶ See <i>Surface Materials</i>, page C252.

Options	Price	Required to Specify
Surface Materials <ul style="list-style-type: none"> • Open Line laminate 	+\$60 plus cost of laminate	▶ See <i>Surface Materials Reference Manual</i> to specify.
Related Products <ul style="list-style-type: none"> • End panels • Off-module end panels • Cantilevers • End-of-run cantilevers • Side-support brackets • Off-module worksurface bracket • Off-module tie plate 		<ul style="list-style-type: none"> ▶ Page C136 ▶ Page C137 ▶ Page C137 ▶ Page C138 ▶ Page C138 ▶ Page C139 ▶ Page C139

Specification Information

Dimensions	Style	Base
A B C D	Number	Price

Corner Worksurfaces

24"	24"	42"	42"	ZCT24244242	\$570
24"	24"	48"	48"	ZCT24244848	\$580
24"	30"	48"	48"	ZCT24304848	\$598
30"	24"	48"	48"	ZCT30244848	\$598
30"	30"	48"	48"	ZCT30304848	\$617

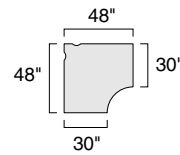
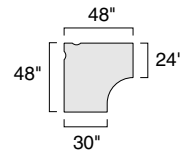
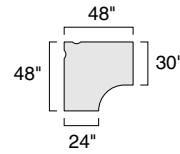
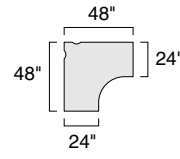
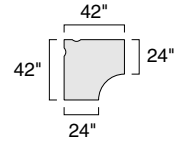

Extended Corner Worksurfaces

Left-Hand

SIN 711.1

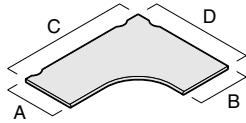

Tip: Pallets range between 10–25 worksurfaces.

Standard Includes	Required to Specify
-------------------	---------------------

- Worksurface: laminate
- Worksurface edge: vinyl default sides and vinyl default torus edge on front
- Cable scallops
- Alignment plate package
- Palletization of worksurfaces

- 1 Style number
 - 2 Laminate color number for worksurface
 - 3 Options, if selected (see below)
- ▶ See *Surface Materials*, page C252.

Options	Price	Required to Specify
---------	-------	---------------------

Surface Materials	• Open Line laminate +\$60 plus cost of laminate	▶ See <i>Surface Materials Reference Manual</i> to specify.
--------------------------	---	---

Related Products	<ul style="list-style-type: none"> • End panels • Off-module end panels • Cantilevers • End-of-run cantilevers • Side-support brackets • Off-module worksurface bracket • Off-module tie plate • Pedestals • Off-module pedestals 	<ul style="list-style-type: none"> ▶ Page C136 ▶ Page C137 ▶ Page C137 ▶ Page C138 ▶ Page C138 ▶ Page C139 ▶ Page C139 ▶ Page C163 ▶ Page C164
-------------------------	--	---

Specification Information					
Dimensions				Style	Base
A	B	C	D	Number	Price

Left-Hand Worksurfaces

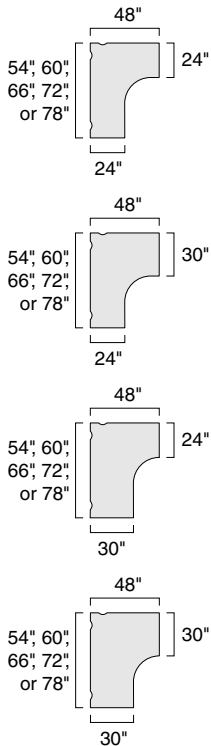

24"	24"	54"	48"	ZCT24245448	\$573
24"	24"	60"	48"	ZCT24246048	\$612
24"	24"	66"	48"	ZCT24246648	\$640
24"	24"	72"	48"	ZCT24247248	\$666
24"	24"	78"	48"	ZCT24247848	\$694
24"	30"	54"	48"	ZCT24305448	\$581
24"	30"	60"	48"	ZCT24306048	\$618
24"	30"	66"	48"	ZCT24306648	\$667
24"	30"	72"	48"	ZCT24307248	\$717
24"	30"	78"	48"	ZCT24307848	\$769
30"	24"	54"	48"	ZCT30245448	\$581
30"	24"	60"	48"	ZCT30246048	\$618
30"	24"	66"	48"	ZCT30246648	\$667
30"	24"	72"	48"	ZCT30247248	\$717
30"	24"	78"	48"	ZCT30247848	\$769
30"	30"	54"	48"	ZCT30305448	\$590
30"	30"	60"	48"	ZCT30306048	\$637
30"	30"	66"	48"	ZCT30306648	\$702
30"	30"	72"	48"	ZCT30307248	\$770
30"	30"	78"	48"	ZCT30307848	\$835

Extended Corner Worksurfaces

Right-Hand
SIN 711.1

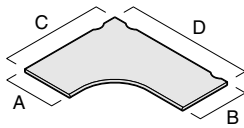

Tip: Pallets range between 10–25 worksurfaces.

Standard Includes	Required to Specify
<ul style="list-style-type: none"> • Worksurface: laminate • Worksurface edge: vinyl default sides and vinyl default torus edge on front • Cable scallops • Alignment plate package • Palletization of worksurfaces 	<ol style="list-style-type: none"> 1 Style number 2 Laminate color number for worksurface 3 Options, if selected (see below) <p>▶ See <i>Surface Materials</i>, page C252.</p>

Options	Price	Required to Specify
Surface Materials <ul style="list-style-type: none"> • Open Line laminate 	+\$60 plus cost of laminate	▶ See <i>Surface Materials Reference Manual</i> to specify.
Related Products <ul style="list-style-type: none"> • End panels • Off-module end panels • Cantilevers • End-of-run cantilevers • Side-support brackets • Off-module worksurface bracket • Off-module tie plate • Pedestals • Off-module pedestals 		<ul style="list-style-type: none"> ▶ Page C136 ▶ Page C137 ▶ Page C137 ▶ Page C138 ▶ Page C138 ▶ Page C139 ▶ Page C139 ▶ Page C163 ▶ Page C164

Specification Information

Dimensions				Style	Base
A	B	C	D	Number	Price

Right-Hand Worksurfaces

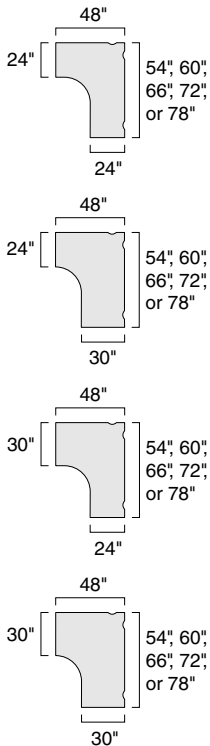

24"	24"	48"	54"	ZCT24244854	\$573
24"	24"	48"	60"	ZCT24244860	\$612
24"	24"	48"	66"	ZCT24244866	\$640
24"	24"	48"	72"	ZCT24244872	\$666
24"	24"	48"	78"	ZCT24244878	\$694
24"	30"	48"	54"	ZCT24304854	\$581
24"	30"	48"	60"	ZCT24304860	\$618
24"	30"	48"	66"	ZCT24304866	\$667
24"	30"	48"	72"	ZCT24304872	\$717
24"	30"	48"	78"	ZCT24304878	\$769
30"	24"	48"	54"	ZCT30244854	\$581
30"	24"	48"	60"	ZCT30244860	\$618
30"	24"	48"	66"	ZCT30244866	\$667
30"	24"	48"	72"	ZCT30244872	\$717
30"	24"	48"	78"	ZCT30244878	\$769
30"	30"	48"	54"	ZCT30304854	\$590
30"	30"	48"	60"	ZCT30304860	\$637
30"	30"	48"	66"	ZCT30304866	\$702
30"	30"	48"	72"	ZCT30304872	\$770
30"	30"	48"	78"	ZCT30304878	\$835

Extended Corner Cove Worksurfaces

SIN 711.1

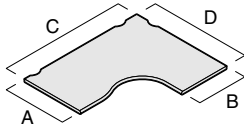

Tip: Pallets range between 10–25 worksurfaces.

Standard Includes	Required to Specify
<ul style="list-style-type: none"> • Worksurface: laminate • Worksurface edge: vinyl default sides and vinyl default torus edge on front • Cable scallops • Alignment plate package • Palletization of worksurfaces 	<ul style="list-style-type: none"> 1 Style number 2 Laminate color number for worksurface 3 Options, if selected (see below) ▶ See <i>Surface Materials</i>, page C252.

Options	Price	Required to Specify
Surface Materials <ul style="list-style-type: none"> • Open Line laminate 	+\$60 plus cost of laminate	▶ See <i>Surface Materials Reference Manual</i> to specify.
Related Products <ul style="list-style-type: none"> • End panels • Off-module end panels • Cantilevers • End-of-run cantilevers • Side-support brackets • Off-module worksurface bracket • Off-module tie plate • Pedestals • Off-module pedestals 		<ul style="list-style-type: none"> ▶ Page C136 ▶ Page C137 ▶ Page C137 ▶ Page C138 ▶ Page C138 ▶ Page C139 ▶ Page C139 ▶ Page C163 ▶ Page C164

Specification Information

• Dimensions				• Style	• Base
A	B	C	D	Number	Price

Left-Hand Worksurfaces

30"	24"	60"	48"	ZCV30246048	\$710
30"	24"	66"	48"	ZCV30246648	\$768
30"	24"	72"	48"	ZCV30247248	\$826
30"	24"	78"	48"	ZCV30247848	\$897
:	:	:	:	:	:

Right-Hand Worksurfaces

24"	30"	48"	60"	ZCV24304860	\$710
24"	30"	48"	66"	ZCV24304866	\$768
24"	30"	48"	72"	ZCV24304872	\$826
24"	30"	48"	78"	ZCV24304878	\$897
:	:	:	:	:	:

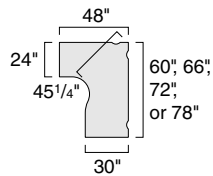
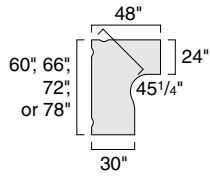

Bubble Visitor Worksurfaces

SIN 711.1

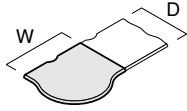

Tip: Pallets range between 10–25 worksurfaces.

Standard Includes

- Worksurface: laminate
- Worksurface edge: vinyl default sides and vinyl default torus edge on front
- Cable scallops
- Alignment plate package
- Palletization of worksurfaces

Required to Specify

- 1 Style number
 - 2 Laminate color number for worksurface
 - 3 Options, if selected (see below)
- ▶ See *Surface Materials*, page C252.

Options

Surface Materials	Options	Price	Required to Specify
	• Open Line laminate	+\$60 plus cost of laminate	▶ See <i>Surface Materials Reference Manual</i> to specify.

Related Products	Options	Price	Required to Specify
	• Cantilevers		▶ Page C137
	• Side-support brackets		▶ Page C138
	• Adjustable column		▶ Page C139
	• Off-module worksurface bracket		▶ Page C139
	• Off-module tie plate		▶ Page C139

Specification Information

Dimensions	Style Number	Base Price
D	W	

Left-Hand Worksurfaces

24"	30"	ZBV2430L	\$309
30"	30"	ZBV3030L	\$276

Right-Hand Worksurfaces

24"	30"	ZBV2430R	\$309
30"	30"	ZBV3030R	\$276

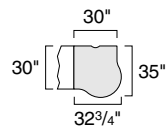
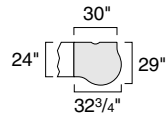
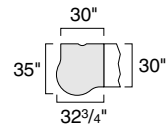
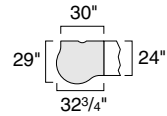

Jetty Worksurfaces

SIN 711.1

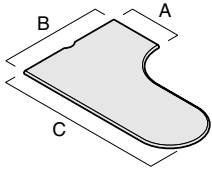

Tip: Pallets range between 10–25 worksurfaces.

Standard Includes	Required to Specify
<ul style="list-style-type: none"> • Worksurface: laminate • Worksurface edge: vinyl default sides and vinyl default torus edge on front • Cable scallops • Alignment plate package • Palletization of worksurfaces 	<ul style="list-style-type: none"> 1 Style number 2 Laminate color number for worksurface 3 Options, if selected (see below) ▶ See <i>Surface Materials</i>, page C252.

Options	Price	Required to Specify
Surface Materials <ul style="list-style-type: none"> • Open Line laminate 	+\$60 plus cost of laminate	▶ See <i>Surface Materials Reference Manual</i> to specify.
Related Products <ul style="list-style-type: none"> • Cantilevers • Side-support brackets • Adjustable column • Off-module worksurface bracket • Off-module tie plate 		<ul style="list-style-type: none"> ▶ Page C137 ▶ Page C138 ▶ Page C139 ▶ Page C139 ▶ Page C139

Specification Information				
Dimensions			Style	Base
A	B	C	Number	Price

Left-Hand Worksurfaces

24"	48"	66"	ZJ30246648L	\$693
24"	48"	78"	ZJ30247848L	\$689
30"	48"	66"	ZJ30306648L	\$621
30"	48"	78"	ZJ30307848L	\$710

Right-Hand Worksurfaces

24"	48"	66"	ZJ24304866R	\$693
24"	48"	78"	ZJ24304878R	\$689
30"	48"	66"	ZJ30304866R	\$621
30"	48"	78"	ZJ30304878R	\$710

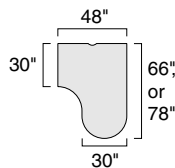
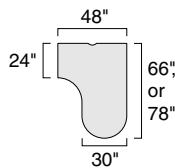
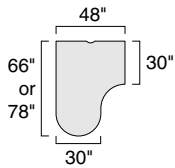
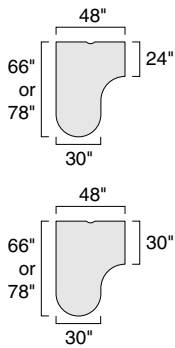

Bubble Jetty Worksurfaces

SIN 711.1

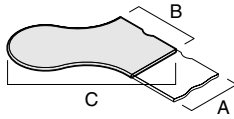

Tip: Pallets range between 10–25 worksurfaces.

Standard Includes	Required to Specify
-------------------	---------------------

- Worksurface: laminate
- Worksurface edge: vinyl default sides and vinyl default torus edge on front
- Cable scallops
- Alignment plate package
- Palletization of worksurfaces

- 1 Style number
- 2 Laminate color number for worksurface
- 3 Options, if selected (see below)
- ▶ See *Surface Materials*, page C252.

Options	Price	Required to Specify
---------	-------	---------------------

Surface Materials	<ul style="list-style-type: none"> • Open Line laminate 	+\$60 plus cost of laminate	▶ See <i>Surface Materials Reference Manual</i> to specify.
--------------------------	--	--------------------------------	---

Related Products	<ul style="list-style-type: none"> • Cantilevers • Side-support brackets • Adjustable column • Off-module worksurface bracket • Off-module tie plate 		<ul style="list-style-type: none"> ▶ Page C137 ▶ Page C138 ▶ Page C139 ▶ Page C139 ▶ Page C139
-------------------------	---	--	---

Specification Information				
Dimensions			Style	Base
A	B	C	Number	Price

Left-Hand Bubble Jetty Worksurfaces

24"	30"	60"	ZBJ243060L	\$640
-----	-----	-----	-------------------	-------

30"	30"	66"	ZBJ303066L	\$589
-----	-----	-----	-------------------	-------

Right-Hand Bubble Jetty Worksurfaces

24"	30"	60"	ZBJ243060R	\$640
-----	-----	-----	-------------------	-------

30"	30"	66"	ZBJ303066R	\$589
-----	-----	-----	-------------------	-------

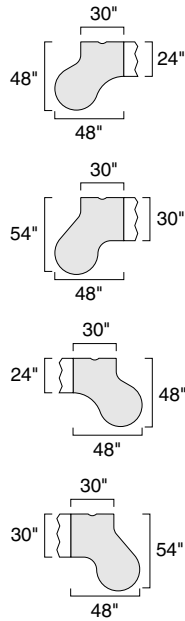

Spanner and Fanned Spanner Worksurfaces

SIN 711.1



Tip: Pallets range between 10–25 worksurfaces.

Standard Includes	Required to Specify
<ul style="list-style-type: none"> • Worksurface: laminate • Worksurface edge: vinyl default sides and vinyl default torus edge on front • Alignment plate package • Palletization of worksurfaces 	<ul style="list-style-type: none"> 1 Style number 2 Laminate color number for worksurface 3 Options, if selected (see below) ▶ See <i>Surface Materials</i>, page C252.

Options	Price	Required to Specify
Surface Materials <ul style="list-style-type: none"> • Open Line laminate 	+\$60 plus cost of laminate	▶ See <i>Surface Materials Reference Manual</i> to specify.
Related Products <ul style="list-style-type: none"> • Cantilevers • Adjustable column 		▶ Page C137 ▶ Page C139

Specification Information

• Width	• Style Number	• Base Price
•	•	•
•	•	•

Spanner Worksurfaces

51"	ZSP51	\$577
-----	--------------	-------

63"	ZSP63	\$614
-----	--------------	-------

Fanned Spanner Worksurfaces

51"	ZFS51	\$614
-----	--------------	-------

63"	ZFS63	\$649
-----	--------------	-------

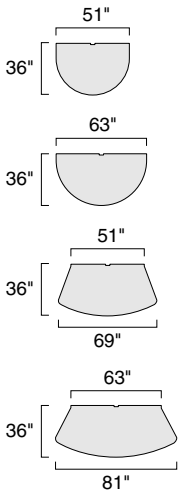

Straight Countertops

SIN 711.1

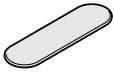

Tip: Straight countertops are non-handed. You don't need to specify left-hand or right-hand versions.

Tip: Countertops cannot be mounted off module.

Tip: See Service Parts to specify countertop brackets required for frames manufactured prior to June 11, 2001.

Standard Includes	Required to Specify
-------------------	---------------------

- Countertop: laminate
- Countertop edge: vinyl default torus edge
- Bracket: black paint only

- 1 Style number
- 2 Laminate color number for countertop
- ▶ See *Surface Materials*, page C252.

Options	Price	Required to Specify
---------	-------	---------------------

Surface Materials

- Open Line laminate

+\$60
plus cost of laminate

▶ See *Surface Materials Reference Manual* to specify.

Specification Information				
	Both Ends Round	One End Round	Both Ends Straight	



Frame Width	Style Number	Style Number	Style Number	Base Price
24"	ZSC24RR	ZSC24RS	ZSC24SS	\$470
30"	ZSC30RR	ZSC30RS	ZSC30SS	\$488
36"	ZSC36RR	ZSC36RS	ZSC36SS	\$509
42"	ZSC42RR	ZSC42RS	ZSC42SS	\$530
48"	ZSC48RR	ZSC48RS	ZSC48SS	\$555
54"	ZSC54RR	ZSC54RS	ZSC54SS	\$610
60"	ZSC60RR	ZSC60RS	ZSC60SS	\$631
66"	ZSC66RR	ZSC66RS	ZSC66SS	\$659
72"	ZSC72RR	ZSC72RS	ZSC72SS	\$677
78"	ZSC78RR	ZSC78RS	ZSC78SS	\$712
84"	ZSC84RR	ZSC84RS	ZSC84SS	\$739
90"	ZSC90RR*	ZSC90RS	ZSC90SS	\$767
96"	ZSC96RR*	ZSC96RS*	ZSC96SS	\$794

* Countertops are shipped in two pieces and assembled in the field.

Montage

Corner Countertops

Both Ends Round or Both Ends Straight

SIN 711.1



Tip: Countertops with straight ends do not extend beyond frame.

Tip: See Service Parts to specify countertop brackets required for frames manufactured prior to June 11, 2001.

Standard Includes	Required to Specify
-------------------	---------------------

- Countertop: laminate
- Countertop edge: vinyl default torus edge
- Bracket: black paint only

- 1 Style number
- 2 Laminate color number for countertop
- ▶ See *Surface Materials*, page C252.

Specification Information

Both Ends Round

Both Ends Straight

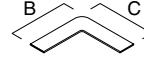
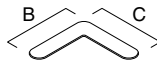

• Dimensions of Frame		• Style Number	• Style Number	• Price
B	C			
24"	24"	ZCC24R24R	ZCC24S24S	\$600
24"	30"	ZCC24R30R	ZCC24S30S	\$610
24"	36"	ZCC24R36R	ZCC24S36S	\$620
24"	42"	ZCC24R42R	ZCC24S42S	\$630
24"	48"	ZCC24R48R	ZCC24S48S	\$640
30"	24"	ZCC30R24R	ZCC30S24S	\$610
30"	30"	ZCC30R30R	ZCC30S30S	\$620
30"	36"	ZCC30R36R	ZCC30S36S	\$630
30"	42"	ZCC30R42R	ZCC30S42S	\$640
30"	48"	ZCC30R48R	ZCC30S48S	\$670
36"	24"	ZCC36R24R	ZCC36S24S	\$620
36"	30"	ZCC36R30R	ZCC36S30S	\$630
36"	36"	ZCC36R36R	ZCC36S36S	\$640
36"	42"	ZCC36R42R	ZCC36S42S	\$670
36"	48"	ZCC36R48R	ZCC36S48S	\$680
42"	24"	ZCC42R24R	ZCC42S24S	\$630
42"	30"	ZCC42R30R	ZCC42S30S	\$640
42"	36"	ZCC42R36R	ZCC42S36S	\$660
42"	42"	ZCC42R42R	ZCC42S42S	\$680
42"	48"	ZCC42R48R	ZCC42S48S	\$700
48"	24"	ZCC48R24R	ZCC48S24S	\$640
48"	30"	ZCC48R30R	ZCC48S30S	\$660
48"	36"	ZCC48R36R	ZCC48S36S	\$680
48"	42"	ZCC48R42R	ZCC48S42S	\$700
48"	48"	ZCC48R48R	ZCC48S48S	\$740

Corner Countertops

Left End Straight and Right End Round or
Left End Round and Right End Straight

SIN 711.1



Tip: Countertops with straight ends do not extend beyond frame.

Tip: Countertops cannot be mounted off module.

Tip: See Service Parts to specify countertop brackets required for frames manufactured prior to June 11, 2001.

Standard Includes	Required to Specify
-------------------	---------------------

- Countertop: laminate
- Countertop edge: vinyl default torus edge
- Bracket: black paint only

- 1 Style number
- 2 Laminate color number for countertop
- ▶ See *Surface Materials*, page C252.

Specification Information

Left End Straight

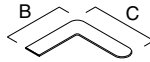

Left End Round

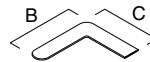

Dimensions of Frame		Left End Straight	Left End Round	Price
B	C	Style Number	Style Number	
24"	24"	ZCC24S24R	ZCC24R24S	\$600
24"	30"	ZCC24S30R	ZCC24R30S	\$610
24"	36"	ZCC24S36R	ZCC24R36S	\$620
24"	42"	ZCC24S42R	ZCC24R42S	\$630
24"	48"	ZCC24S48R	ZCC24R48S	\$640
30"	24"	ZCC30S24R	ZCC30R24S	\$610
30"	30"	ZCC30S30R	ZCC30R30S	\$620
30"	36"	ZCC30S36R	ZCC30R36S	\$630
30"	42"	ZCC30S42R	ZCC30R42S	\$640
30"	48"	ZCC30S48R	ZCC30R48S	\$670
36"	24"	ZCC36S24R	ZCC36R24S	\$620
36"	30"	ZCC36S30R	ZCC36R30S	\$630
36"	36"	ZCC36S36R	ZCC36R36S	\$640
36"	42"	ZCC36S42R	ZCC36R42S	\$670
36"	48"	ZCC36S48R	ZCC36R48S	\$680
42"	24"	ZCC42S24R	ZCC42R24S	\$630
42"	30"	ZCC42S30R	ZCC42R30S	\$640
42"	36"	ZCC42S36R	ZCC42R36S	\$660
42"	42"	ZCC42S42R	ZCC42R42S	\$680
42"	48"	ZCC42S48R	ZCC42R48S	\$700
48"	24"	ZCC48S24R	ZCC48R24S	\$640
48"	30"	ZCC48S30R	ZCC48R30S	\$660
48"	36"	ZCC48S36R	ZCC48R36S	\$680
48"	42"	ZCC48S42R	ZCC48R42S	\$700
48"	48"	ZCC48S48R	ZCC48R48S	\$740

Montage

Worksurface Supports

SIN 711.1

Standard End Panels

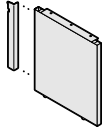

Tip: End panels work in on-module vertical upright situations only.

Tip: Standard end panels can be converted to off-module end panels by ordering a panel package from Service Parts.

Standard Includes	Required to Specify
<ul style="list-style-type: none"> End panel: paint price group 1 Interface bracket Attachment hardware 	<ul style="list-style-type: none"> 1 Style number 2 Paint color number for end panel 3 Options, if selected (see below) <p>▶ See <i>Surface Materials</i>, page C252.</p>

Options	Price	Required to Specify
Surface Materials <ul style="list-style-type: none"> Paint price group 1 Paint price group 2 Paint price group 3 	<ul style="list-style-type: none"> No cost +\$17 +\$29 	<ul style="list-style-type: none"> Specify paint color number. Specify paint color number. Specify paint color number.

Specification Information

Depth	Style Number	Base Price

Left-Hand End Panels

24"	ZEP24LH	\$165
30"	ZEP30LH	\$176

Right-Hand End Panels

24"	ZEP24RH	\$165
30"	ZEP30RH	\$176

Off-Module End Panels

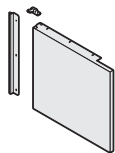

Tip: End panels work in off-module situations only.

Tip: Off-module end panels can be converted to standard end panels by ordering a panel package from Service Parts.

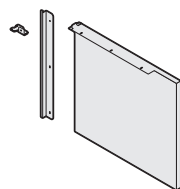
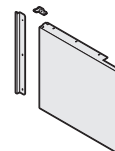

Standard Includes		Required to Specify	
-------------------	--	---------------------	--

- End panel: paint price group 1
- Trim kit bracket
- Interface bracket
- Attachment hardware

- 1 Style number
- 2 Paint color number for end panel
- 3 Options, if selected (see below)
- ▶ See *Surface Materials*, page C252.

Surface Materials	Options	Price	Required to Specify
-------------------	---------	-------	---------------------

Surface Materials

- Paint price group 1
- Paint price group 2
- Paint price group 3

No cost
+\$17
+\$29

- Specify paint color number.
- Specify paint color number.
- Specify paint color number.

Specification Information		
Depth	Style Number	Base Price

Depth	Style Number	Base Price
-------	--------------	------------

Left-Hand End Panels

24"	ZEP24LHOM	\$165
30"	ZEP30LHOM	\$176

Right-Hand End Panels

24"	ZEP24RHOM	\$165
30"	ZEP30RHOM	\$176

Cantilevers

Tip: Shared cantilevers can only be used to support worksurfaces with their own column supports—bubble visitor, jetty, bubble jetty, and visitor worksurfaces.

Tip: Shared cantilevers must be used on both sides of a spanner worksurface.

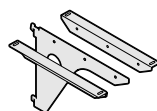
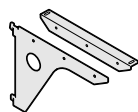

Tip: Cantilevers work in on-module vertical upright situations only.

Standard Includes		Required to Specify	
-------------------	--	---------------------	--

- Cantilever and attachment brackets: black paint only

- Style number

Specification Information	
Style Number	Price

Style Number	Price
--------------	-------

Cantilever (non-handed)

ZCB	\$37
------------	------

Shared Cantilever

ZCSB	\$49
-------------	------

Worksurface Supports, continued

SIN 711.1

End-of-Run Cantilevers

Tip: End-of-run cantilevers are used in on-module vertical upright situations only.

Tip: End-of-run cantilevers are used at the end of a corner worksurface.

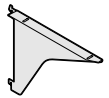
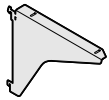

Standard Includes	Required to Specify
<ul style="list-style-type: none"> End-of-run cantilever and attachment brackets: all paint price groups 	1 Style number 2 Paint color number for cantilever ▶ See <i>Surface Materials</i> , page C252.

Specification Information

Style Number	Price

Left-Hand

ZCEL	\$49

Right-Hand

ZCER	\$49

Adjustable-Height Cantilevers

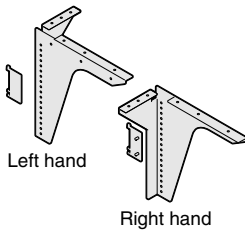

Tip: Requires a third cantilever to support rear of corner worksurface. Also cannot be used in combination with desk-height cable management tray.

Tip: Adjustable-height cantilevers used in on-module vertical upright situations only.

Standard Includes	Required to Specify
<ul style="list-style-type: none"> Cantilever: black paint only 	Style number

Specification Information

Orientation	Style Number	Price
Left-hand	ZCAL	\$158
Right-hand	ZCAR	\$158

Side-Support Brackets



Tip: Side-support bracket includes a pair of handed brackets, only one of which is required for rear corner support of panel-mounted corner worksurfaces. Specify one for every two corner worksurfaces in on-module applications. Order an additional supply for off-module fin wall applications.

C138

Standard Includes	Required to Specify
<ul style="list-style-type: none"> Pair of side-support brackets: black paint only Attachment hardware 	Style number

Specification Information

Style Number	Price
ZBES	\$25

Off-Module Worksurface Bracket



Tip: Brackets are used in off-module situations only.

Tip: Off-module brackets must be used in conjunction with other on-module supports to provide forward worksurface tip support.

Standard Includes	Required to Specify
<ul style="list-style-type: none"> Off-module worksurface bracket: paint Attachment hardware 	1 Style number 2 Paint color number for bracket ▶ See <i>Surface Materials</i> , page C252.

Specification Information

Style Number	Price
ZBWOM	\$25

Off-Module Tie Plate



Tip: Tie plate is used in conjunction with an off-module worksurface bracket.

Tip: Support plate and reinforcing channel can also be used.

▶ See *GSA Answer* chapter.

Standard Includes	Required to Specify
<ul style="list-style-type: none"> Tie plate: black paint only 	Style number

Specification Information

Style Number	Price
ZBTP	\$20

Adjustable Column



Tip: Fanned spanner work-surfaces require two columns.

Standard Includes	Required to Specify
<ul style="list-style-type: none"> Column: all paint price groups 	1 Style number 2 Paint color number for column ▶ See <i>Surface Materials</i> , page C252.

Specification Information

Style Number	Price
ZAP	\$133

Adjustable-Height Worksurfaces

with Crank

SIN 711.1

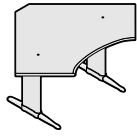

Tip: Adjustable-height mechanism requires assembly and attachment to the worksurface.

Tip: Extension-link work-surfaces may be attached only to corner or bi-level worksurfaces.

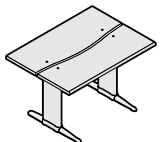
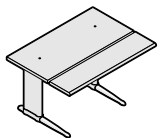
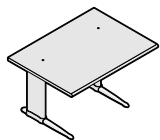
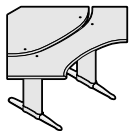
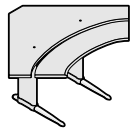
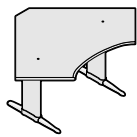

Tip: Gas cylinder package can be field installed to single and dual crank-adjustable worksurfaces to provide additional lift.

Standard Includes	Required to Specify
<ul style="list-style-type: none"> • Worksurface: laminate • Torus-edge front: vinyl (PVC) default • Side and back edges: vinyl (PVC) default • Adjustable-height column mechanism and base: paint price group 1 • Crank handle 	<ol style="list-style-type: none"> 1 Style number 2 Laminate color number for worksurface 3 Paint color number for column and base 4 Options, if selected (see below) <p>▶ See <i>Surface Materials</i>, page C252.</p>

Options	Price	Required to Specify
Surface Materials <ul style="list-style-type: none"> • Paint price group 1 • Paint price group 2 • Paint price group 3 • Accent laminate • Open Line laminate 	No cost +\$34 +\$58 +\$60 +\$60 plus cost of laminate	Specify paint color number. Specify paint color number. Specify paint color number. ▶ See <i>Surface Materials Reference Manual</i> . ▶ See <i>Surface Materials Reference Manual</i> .

Specification Information

• Dimensions		• Style	• Base
D	W	Number	Price

Corner Worksurfaces

22¼"	39¼"	ZCKSC42	\$1608
22¼"	45¼"	ZCKSC48	\$1653

Dual Corner Worksurfaces

22¼"	39¼"	ZCKDC42	\$2208
22¼"	45¼"	ZCKDC48	\$2253

Bi-Level Corner Worksurfaces

22¼"	39¼"	ZCKBC42	\$2208
22¼"	45¼"	ZCKBC48	\$2253

Straight Worksurfaces

28¼"	40"	ZCKSS42	\$1518
28¼"	46"	ZCKSS48	\$1567

Dual Straight Worksurfaces

34¼"	40"	ZCKDS42	\$2118
34¼"	46"	ZCKDS48	\$2167

Bi-Level Straight Worksurfaces

34¼"	40"	ZCKBS42	\$2118
34¼"	46"	ZCKBS48	\$2167

Pair of Gas Cylinders

	ADJHTGASCYL	\$ 150
--	--------------------	--------

Adjustable-Height Extension Worksurfaces

Crank Adjustable
SIN 711.1

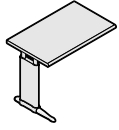

Tip: Extension-link worksurfaces may be attached only to corner or bi-level worksurfaces. They cannot be attached to dual worksurfaces.

Tip: Adjustable-height mechanism requires assembly and attachment to the worksurface.

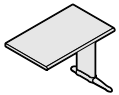
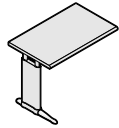

Standard Includes	Required to Specify
-------------------	---------------------

- | | |
|---|---|
| <ul style="list-style-type: none"> • Worksurface: laminate • Torus-edge front: vinyl (PVC) default • Side and back edges: vinyl (PVC) default • Adjustable-height mechanism • Leg shroud and foot: paint price group 1 • Gas cylinder | <ol style="list-style-type: none"> 1 Style number 2 Laminate color number for worksurface 3 Paint color number for leg shroud and foot 4 Options, if selected (see below) <p>▶ See <i>Surface Materials</i>, page C252.</p> |
|---|---|

Surface Materials	Options	Price	Required to Specify
-------------------	---------	-------	---------------------

- | | | |
|--|--|--|
| <ul style="list-style-type: none"> • Paint price group 1 • Paint price group 2 • Paint price group 3 • Accent laminate • Open Line laminate | <p>No cost</p> <p>+\$17</p> <p>+\$29</p> <p>+\$60</p> <p>+\$60 plus cost of laminate</p> | <p>Specify paint color number.</p> <p>Specify paint color number.</p> <p>Specify paint color number.</p> <p>▶ See <i>Surface Materials Reference Manual</i>.</p> <p>▶ See <i>Surface Materials Reference Manual</i>.</p> |
|--|--|--|

Specification Information

• Dimensions	• Style	• Base
D W	Number	Price

Left-Hand

22¼"	24"	ZCKEL24	\$1230
22¼"	36"	ZCKEL36	\$1341
:	:	:	:

Right-Hand

22¼"	24"	ZCKER24	\$1230
22¼"	36"	ZCKER36	\$1341
:	:	:	:

Adjustable-Height Worksurfaces

with Electrically Adjustable Column Support

SIN 711.1

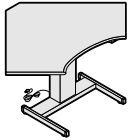

Tip: Adjustable-height mechanism requires attachment to the base and work surface.

Standard Includes	Required to Specify
-------------------	---------------------

- Worksurface with 150-pound capacity: laminate
- Torus-edge front: vinyl (PVC) default
- Side and back edges: vinyl (PVC) default
- Drawer-mounted two-button controller
- Adjustable-height column mechanism and base: paint price group 2
- 9' power cord: black vinyl only
- Attachment hardware

- 1 Style number
 - 2 Laminate color number for worksurface
 - 3 Paint color number for column and base
 - 4 Options, if selected (see below)
- ▶ See *Surface Materials*, page C252.

Options	Price	Required to Specify
---------	-------	---------------------

Surface Materials	<ul style="list-style-type: none"> • Paint price group 1 • Paint price group 2 • Paint price group 3 • Accent laminate • Open Line laminate 	No cost +\$ 34 +\$ 58 +\$ 60 +\$ 60	Specify paint color number. Specify paint color number. Specify paint color number. ▶ See <i>Surface Materials Reference Manual</i> . ▶ See <i>Surface Materials Reference Manual</i> .
Programmable Memory	<ul style="list-style-type: none"> • Drawer-mounted six-button controller with 3x3 programmable memory and soft-start/soft-stop 	+\$299	Specify with <i>SSM</i> .
High-Performance Adjustable-Height Worksurface with Programmable Memory	<ul style="list-style-type: none"> • 250-pound weight capacity and drawer-mounted six-button controller with 3x3 programmable memory and soft-start/soft-stop 	+\$699	Specify with <i>250SSM</i> .

Specification Information

Planning Dimensions	Style Number	Base Price
D W		

Corner Worksurfaces

24"	42"	ZECSC42	\$1968
24"	48"	ZECSC48	\$2013
:	:	:	:

Dual Corner Worksurfaces

24"	42"	ZECDC42	\$2568
24"	48"	ZECDC48	\$2613
:	:	:	:

Straight Worksurfaces

30"	42"	ZECSS42	\$1878
30"	48"	ZECSS48	\$1927
:	:	:	:

Dual Straight Worksurfaces

36"	42"	ZECDS42	\$2478
36"	48"	ZECDS48	\$2527
:	:	:	:

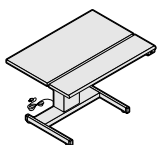
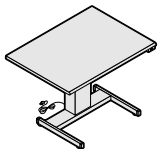
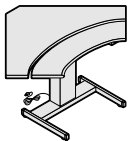
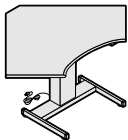

Worksurface Wiring and Cabling

SIN 711.1

Cable and Fiber Reels

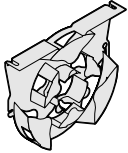

Standard Includes	Required to Specify
<ul style="list-style-type: none"> Package of four reels: black plastic only 	Style number

Specification Information

• Dimensions			• Style	• Price
D	W	H	Number	
1¼"	8"	8 ⁵ / ₁₆ "	98766	\$87
·	·	·	·	·

Termination Plate

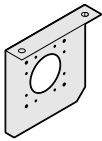

Standard Includes	Required to Specify
<ul style="list-style-type: none"> Termination plate: black paint only 	Style number

Specification Information

• Dimensions			• Style	• Price
D	W	H	Number	
¾"	7 ¹ / ₈ "	7 ¹ / ₈ "	98765	\$14
·	·	·	·	·

Cord Reels

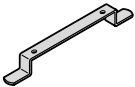

Standard Includes	Required to Specify
<ul style="list-style-type: none"> Carton of six cord reels: black paint only 	Style number

Specification Information

• Style	• Price
Number	
98767	\$37
·	·

Worksurface Wiring and Cabling, continued

SIN 711.1

Wire Guide Clips



Standard Includes		Required to Specify
<ul style="list-style-type: none"> • Carton of 20 adhesive-backed wire guide clips: black plastic only 		Style number
Specification Information		
Style Number	Price	
32WCP	\$21	

Wire Clips



Standard Includes		Required to Specify
<ul style="list-style-type: none"> • Carton of six: black plastic only • Foam tape • Mounting screws 		Style number
Specification Information		
Style Number	U.S. Price	
999CHT	\$37	

Velcro Wire Clips



Tip: Attaches under work-surfaces with screws or around leg.

Note: This product is Turnstone, **NOT** Steelcase. It is included here to simplify your planning. Remember that Steelcase has different pricing terms than Turnstone products.

Standard Includes				Required to Specify
<ul style="list-style-type: none"> • Package of six wire clips: velcro • Attachment hardware 				Style number
Specification Information				
Dimensions			Style Number	U.S. Price
D	W	H		
1/2"	8"	1/2"	TSSLEGCLP	\$33

Post Leg Wire Managers



Standard Includes	Required to Specify
<ul style="list-style-type: none"> Package of 20 wire managers: black plastic only 	Style number

Specification Information

Style Number	U.S. Price
TS7LWM	\$30

Wire Manager



Standard Includes	Required to Specify
<ul style="list-style-type: none"> 25" wire manager with double-sided tape: black plastic 	Style number

Specification Information

Dimensions			Style Number	U.S. Price
D	W	H		
1"	3/4"	25"	PTWM25	\$12

Ganging Bracket for Tables

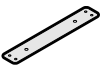

Note: This product is Turnstone, NOT Steelcase. It is included here to simplify your planning. Remember that Steelcase has different pricing terms from Turnstone products.

Standard Includes	Required to Specify
<ul style="list-style-type: none"> Ganging bracket: black paint 	Style number

Specification Information

Dimensions			Style Number	U.S. Price
D	W	H		
1 1/2"	9"		TS5GANGBKT	\$14

SIN 711.1

Cable Storage Tray

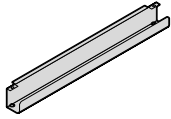

Standard Includes	Required to Specify
<ul style="list-style-type: none"> Cable storage tray: black paint only 	Style number

Specification Information

Dimensions			Style Number	Price
D	W	H		
2"	24"	2½"	98768	\$28

Power Strips

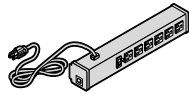

Standard Includes	Required to Specify
<ul style="list-style-type: none"> Power strip with 6' cord and three-prong plug: Grey Value 5 paint only 	Style number

Specification Information

Style Number	Price
Without Line Conditioner	
88PS	\$ 68
With Line Conditioner	
88PSLC	\$171

Specifying Montage Storage

► For more detailed product information, see the *Montage Solutions Specification Guide* or consult your Steelcase dealer.

Storage

Universal Overhead Bins (SIN 711.1)	C148
Universal Overhead Bins with Wood Door (SIN 711.1)	C150
Universal Full-Height Shelves (SIN 711.1)	C151
Bracket Application Rules (SIN 711.1)	C152
Accessories (SIN 711.1)	C153
Wall Channels (SIN 711.1)	C154
Horizontal Braces (SIN 711.1)	C155
Dividers (SIN 711.1)	C156
Universal Curved Front Bins (SIN 711.1)	C157
Universal Curved Front Bins with Wood Door (SIN 711.1)	C158
Universal L-Shelves (SIN 711.1)	C159
Bracket Application Rules (SIN 711.1)	C160
Add-On Shelves (SIN 711.1)	C161
Accessories (SIN 711.1)	C162
Montage Fixed Pedestals (SIN 711.1)	C163

Universal Overhead Bins

SIN 711.1

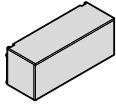

Standard Includes	Required to Specify
<ul style="list-style-type: none"> Overhead storage bin: paint price group 1 On-module brackets: black only Lock, keyed random: 9201 Polished Chrome 	<ul style="list-style-type: none"> 1 Style number 2 Paint color number for storage bin, and off-module brackets, if selected 3 Options, if selected (see below) ▶ See <i>Surface Materials</i>, page C252.

Options	Price	Required to Specify
Surface Materials Bin with one door <ul style="list-style-type: none"> Paint price group 1 Paint price group 2 Paint price group 3 Bin with two doors <ul style="list-style-type: none"> Paint price group 1 Paint price group 2 Paint price group 3 	<ul style="list-style-type: none"> No cost +\$ 38 +\$ 65 No cost +\$ 53 +\$ 90 	<ul style="list-style-type: none"> Specify paint color number. Specify paint color number. Specify paint color number. Specify paint color number. Specify paint color number. Specify paint color number.
Brackets Off-module brackets for horizontal slot patterned panels <ul style="list-style-type: none"> Enhanced off-module Montage (option for bins 24"W-48"W only) 	<ul style="list-style-type: none"> +\$100 	<ul style="list-style-type: none"> Specify with <i>off-module bracket – enhanced off-module Montage</i>.
Lock and Keying Lock <ul style="list-style-type: none"> Ember Chrome Keying <ul style="list-style-type: none"> Factory- and field-installed keying 	<ul style="list-style-type: none"> No cost 	<ul style="list-style-type: none"> Specify with <i>9250 Ember Chrome lock</i>. ▶ Page C262
Related Products <ul style="list-style-type: none"> Dividers Shelf lighting 		<ul style="list-style-type: none"> ▶ Page C162 ▶ Page C237

Specification Information					
Dimensions			Old Style	New Style	Base
D	W	H	Number	Number	Price

For Use With Montage

Bin Without Lock					
14¾"	24"	17⅛"	ZBB24	JBIN24MON	\$330
14¾"	30"	17⅛"	ZBB30	JBIN30MON	\$341
14¾"	36"	17⅛"	ZBB36	JBIN36MON	\$368
14¾"	42"	17⅛"	ZBB42	JBIN42MON	\$381
14¾"	48"	17⅛"	ZBB48	JBIN48MON	\$393
With Two Doors					
14¾"	60"	17⅛"	ZBB60	JBIN60MON	\$591
14¾"	72"	17⅛"	ZBB72	JBIN72MON	\$656

▶ Specification Information, continued

► Specification Information, continued

Specification Information

Dimensions			Old Style	New Style	Base
D	W	H	Number	Number	Price

For Use with Montage

Bin With Lock

14 ³ / ₄ "	24"	17 ¹ / ₈ "	ZBBL24	JBIN24LMON	\$380
14 ³ / ₄ "	30"	17 ¹ / ₈ "	ZBBL30	JBIN30LMON	\$391
14 ³ / ₄ "	36"	17 ¹ / ₈ "	ZBBL36	JBIN36LMON	\$418
14 ³ / ₄ "	42"	17 ¹ / ₈ "	ZBBL42	JBIN42LMON	\$431
14 ³ / ₄ "	48"	17 ¹ / ₈ "	ZBBL48	JBIN48LMON	\$443

With Two Doors

14 ³ / ₄ "	60"	17 ¹ / ₈ "	ZBBL60	JBIN60LMON	\$691
14 ³ / ₄ "	72"	17 ¹ / ₈ "	ZBBL72	JBIN72LMON	\$756
:	:	:	:	:	:



Universal Overhead Bin with Wood Door

SIN 711.1

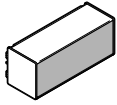

Tip: Only the door is wood. Cabinet is painted metal with standard finishes.

Tip: Veneer is natural flat cut.

Standard Includes	Required to Specify
<ul style="list-style-type: none"> Overhead storage bin: paint price group 1 One door for 24", 30", 36", 42", and 48" bins: wood Two doors for 60" and 72" bins: wood On-module brackets: black only Lock, keyed random: 9201 Polished Chrome 	<ol style="list-style-type: none"> Style number Paint color number for storage bin and off-module brackets, if selected Wood color number for door Options, if selected (see below) <p>▶ See <i>Surface Materials</i>, page C252.</p>

Options	Price	Required to Specify
Surface Materials Bin with one wood door <ul style="list-style-type: none"> Paint price group 1 Paint price group 2 Paint price group 3 Customiz stain on wood veneer 	No cost +\$38 +\$58 +\$62	Specify paint color number. Specify paint color number. Specify paint color number. Specify with <i>Customiz stain</i> . ▶ See <i>Surface Materials Reference Manual</i> .
Bin with two wood doors <ul style="list-style-type: none"> Paint price group 1 Paint price group 2 Paint price group 3 Customiz stain on wood veneer 	No cost +\$53 +\$80 +\$62	Specify paint color number. Specify paint color number. Specify paint color number. Specify with <i>Customiz stain</i> . ▶ See <i>Surface Materials Reference Manual</i> .
Brackets Off-module brackets for horizontal slot patterned panels <ul style="list-style-type: none"> Enhanced off-module Montage (option for bins 24"W-48"W only) 	+\$100	Specify with <i>off-module bracket – Enhanced Off-Module Montage</i> .
Lock and Keying Lock <ul style="list-style-type: none"> Ember Chrome 	No cost	Specify with <i>9250 Ember Chrome lock</i> .
	Keying <ul style="list-style-type: none"> Factory- and field-installed keying 	▶ Page C262
Related Products <ul style="list-style-type: none"> Dividers Shelf lighting 		▶ Page C162 ▶ Page C237

Specification Information			
Dimensions	Old Style	New Style	Base
D W H	Number	Number	Price

For Use with Montage

Bin With Lock						
14¾"	24"	17⅛"	ZBBL24MW	JBIN24LWMON		\$ 630
14¾"	30"	17⅛"	ZBBL30MW	JBIN30LWMON		\$ 660
14¾"	36"	17⅛"	ZBBL36MW	JBIN36LWMON		\$ 690
14¾"	42"	17⅛"	ZBBL42MW	JBIN42LWMON		\$ 720
14¾"	48"	17⅛"	ZBBL48MW	JBIN48LWMON		\$ 750
With Two Doors						
14¾"	60"	17⅛"	ZBBL60MW	JBIN60LWMON		\$1100
14¾"	72"	17⅛"	ZBBL72MW	JBIN72LWMON		\$1190

Universal Full-Height Shelves

SIN 711.1

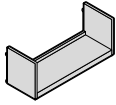

Standard Includes	Required to Specify
-------------------	---------------------

- Shelf: paint price group 1
- On-module brackets: black only

- 1 Style number
 - 2 Paint color number for shelf and off-module brackets, if selected
 - 3 Options, if selected (see below)
- ▶ See *Surface Materials*, page C252.

Options	Price	Required to Specify
---------	-------	---------------------

Surface Materials

- Paint price group 1
- Paint price group 2
- Paint price group 3

No cost
+\$13
+\$21

- Specify paint color number.
Specify paint color number.
Specify paint color number.
▶ See *Surface Materials Reference Manual*.

Brackets

Off-module brackets for horizontal slot patterned panels

- Enhanced off-module Montage (option for bins 24"W–48"W only)

+\$100

Specify *with off-module bracket – Enhanced Off-Module Montage*.

Related Products

- Dividers
- Shelf lighting

- ▶ Page C162
- ▶ Page C237

Specification Information

• Dimensions			• Old Style	• New Style	• Base
D	W	H	Number	Number	Price

For Use with Montage

15 ⁵ / ₈ "	24"	16 ¹ / ₂ "	ZBS24	JSHF24MON	\$138
15 ⁵ / ₈ "	30"	16 ¹ / ₂ "	ZBS30	JSHF30MON	\$148
15 ⁵ / ₈ "	36"	16 ¹ / ₂ "	ZBS36	JSHF36MON	\$168
15 ⁵ / ₈ "	42"	16 ¹ / ₂ "	ZBS42	JSHF42MON	\$171
15 ⁵ / ₈ "	48"	16 ¹ / ₂ "	ZBS48	JSHF48MON	\$181
15 ⁵ / ₈ "	60"	16 ¹ / ₂ "	ZBS60	JSHF60MON	\$202
15 ⁵ / ₈ "	72"	16 ¹ / ₂ "	ZBS72	JSHF72MON	\$214

Montage

Bracket Application Rules

for Overhead Bin and Full-Height Shelf

On-Module Brackets

On-module brackets

are used to mount bins and shelves to panels with vertical slot patterns.

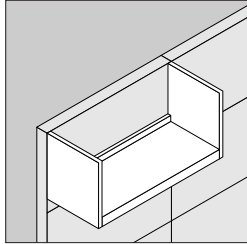
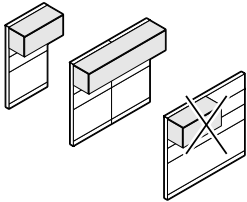

On-module attachment brackets install in panel seams.

Width of overhead storage unit must match the width of the panel or panels that it is attached to.

Additional support for stability may be required when shelves and overhead storage bins are attached to panels. Counterbalancing loads on opposite sides of the panels increases stability.

Tip: See Panel Stability Guidelines.

► See *Montage Solutions Specification Guide*.

Off-Module Brackets

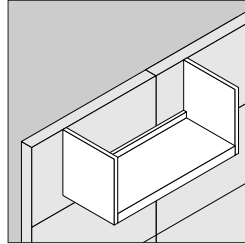

Off-module brackets, optional, accommodate off-module installations of bins and shelves on panels with horizontal slot patterns. Enhanced off-module Montage frames can support off-module brackets. Off-module brackets push bins and shelves $\frac{3}{4}$ " from frame.

Enhanced off-module Montage frames have horizontal slot patterns and must be specified for off-module Montage configurations.

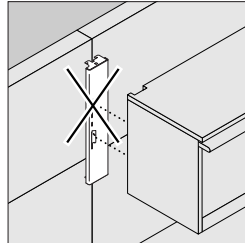

Off-module brackets cannot span a vertical or joint where two frames come together on enhanced off-module Montage frame. Shift bin or shelf to avoid joint.

Accessories

for Overhead Bin and Full-Height Shelf

Divider for Overhead Bin and Full-Height Shelf

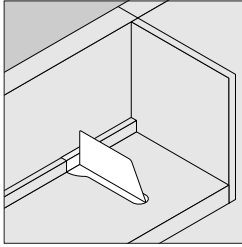
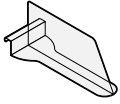

Product Details

Divides space in bins and shelves.

Surface Materials

Divider
• Clear textured plastic only

Actual Dimensions

Depth	10 ³ / ₄ "
Width	4" at the base 1/2" at the top
Height	4 ¹ / ₂ "

Wall Channels

SIN 711.1

Wall Channels for Universal Bins and Shelves

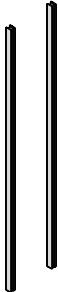

Standard Includes	Required to Specify
<ul style="list-style-type: none"> • Pair of channels: paint 	<ul style="list-style-type: none"> 1 Style number 2 Paint color number for channels ▶ See <i>Surface Materials</i>, page C252.

Specification Information

• Height	• Style Number	• Price
66"	TS7BSWHC	\$49

Tip: Must specify bin or shelf with Technology Wall, Answer, or Kick bracket to hang on wall channel.

Horizontal Braces

SIN 711.1

Horizontal Braces

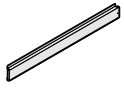

Standard Includes	Required to Specify
<ul style="list-style-type: none"> • Brace: paint 	1 Style number 2 Paint color number for horizontal brace ▶ See <i>Surface Materials</i> , page C252.

Specification Information		
• Width	• Style Number	• Price
42"	TS742HB	\$54
48"	TS748HB	\$54
60"	TS760HB	\$54
72"	TS772HB	\$54
:	:	:

Montage

Dividers

SIN 711.1

Dividers for Overhead Bin and Full-Height Shelf



Standard Includes	Required to Specify
<ul style="list-style-type: none">• Carton of four dividers: clear textured plastic	Style number

Specification Information

• Dimensions			• Style	• Price
D	W	H	Number	
10 ³ / ₄ "	4"	4 ¹ / ₂ "	TS7STDIV	\$35

Universal Curved Front Bins

SIN 711.1

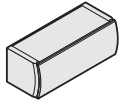

Tip: Basic attachment bracket allows only 12" off-module configurations on panels with vertical attachment. Bin must be the same width or up to 12" wider than the panel.

Tip: Optional brackets allow complete off-module configurations on panels with horizontal slot patterns. Specify with suffix "**NON**" and choose a full off-module bracket option.

Tip: Bin is upmountable on Technology Wall, Answer, and Kick panels. Specify with suffix "**NON**" and choose the upmount bracket option.

Standard Includes	Required to Specify
-------------------	---------------------

- Overhead storage bin: paint price group 1
- Basic attachment bracket: black only
- Lock, keyed random: 9201 Polished Chrome

- 1 Style number with appropriate bracket suffix:
MON = Montage
NON = NO BASIC BRACKET (see bracket options below)
- 2 Paint color number for storage bin
- 3 Options, if selected (see below)
- ▶ See *Surface Materials*, page C252.

Options	Price	Required to Specify
---------	-------	---------------------

Surface Materials	<ul style="list-style-type: none"> • Paint price group 1 • Paint price group 2 	No cost +\$ 28	Specify paint color number. Specify paint color number.
Brackets	Off-module brackets for horizontal slot patterned panels		
	<ul style="list-style-type: none"> • Enhanced off-module Montage 	+\$130	Specify with off-module bracket – enhanced off-module Montage.
Lock and Keying	Lock		
	<ul style="list-style-type: none"> • Ember Chrome 	No cost	Specify with 9250 Ember Chrome lock.
	Keying		
	<ul style="list-style-type: none"> • Factory- and field-installed keying 		▶ Page C262
Related Products	<ul style="list-style-type: none"> • Stationary shelf • Display shelf • Dividers • ADA pull 		▶ Page C161 ▶ Page C161 ▶ Page C162 ▶ Page C162

Specification Information

Dimensions			Style	Base
D	W	H	Number	Price

Curved Front Bins

16½"	30"	15"	KBIN30L__	\$584
16½"	36"	15"	KBIN36L__	\$642
16½"	42"	15"	KBIN42L__	\$730
16½"	45"	15"	KBIN45L__	\$811
16½"	48"	15"	KBIN48L__	\$811

Montage

Universal Curved Front Bins with Wood Door

SIN 711.1

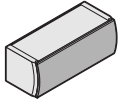

Tip: Only the door is wood. Cabinet is painted metal and end panels are ABS.

Tip: Basic attachment bracket allows only 12" off-module configurations on panels with vertical attachment. Bin must be the same width or up to 12" wider than the panel.

Tip: Optional brackets allow complete off-module configurations on panels with horizontal slot patterns. Specify with suffix "**NON**" and choose a full off-module bracket option.

Standard Includes		Required to Specify	
	<ul style="list-style-type: none"> Overhead storage bin: paint price group 1 Door: wood Basic attachment bracket: black only Lock, keyed random: 9201 Polished Chrome 		1 Style number with appropriate bracket suffix: MON = Montage NON = NO BASIC BRACKET (see bracket options below) 2 Paint color number for storage bin 3 Wood color number for door 4 Options, if selected (see below) ▶ See <i>Surface Materials</i> , page C252.
Options	Price	Required to Specify	
Surface Materials	<ul style="list-style-type: none"> Paint price group 1: No cost Paint price group 2: +\$ 28 Customiz stain on wood door: +\$ 41 	Specify paint color number. Specify paint color number. Specify with <i>Customiz stain</i> . ▶ See <i>Surface Materials Reference Manual</i> .	
Brackets	Off-module brackets for horizontal slot patterned panels		
	<ul style="list-style-type: none"> Enhanced off-module Montage: +\$130 	Specify with <i>off-module bracket – enhanced off-module Montage</i> .	
Lock and Keying	Lock <ul style="list-style-type: none"> Ember Chrome: No cost Keying <ul style="list-style-type: none"> Factory- and field-installed keying 	Specify with <i>9250 Ember Chrome lock</i> . ▶ Page C262	
Related Products	<ul style="list-style-type: none"> Stationary shelf Display shelf Dividers ADA pull 	▶ Page C161 ▶ Page C161 ▶ Page C162 ▶ Page C162	

Specification Information

Dimensions			Style	Base
D	W	H	Number	Price

Curved Front Bins with Wood Door

16½"	30"	15"	KBIN30LW__	\$ 834
16½"	36"	15"	KBIN36LW__	\$ 892
16½"	42"	15"	KBIN42LW__	\$ 980
16½"	45"	15"	KBIN45LW__	\$1061
16½"	48"	15"	KBIN48LW__	\$1061

Universal L-Shelves

SIN 711.1

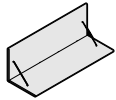

Tip: Basic attachment bracket allows only 12" off-module configurations on panels with vertical attachment. L-shelf must be the same width or up to 12" wider than the panel.

*Tip: Optional brackets allow complete off-module configurations on panels with horizontal slot patterns. Specify with suffix "**NON**" and choose a full off-module bracket option.*

Standard Includes	Required to Specify
<ul style="list-style-type: none"> Shelf: paint price group 1 Basic attachment bracket: black only Rods: shiny chrome Spacers: 6695 Midnight only Endcaps: 6695 Midnight only 	1 Style number with appropriate bracket suffix: MON = Montage NON = NO BASIC BRACKET (see bracket options below) 2 Paint color number for shelf 3 Options, if selected (see below) ▶ See <i>Surface Materials</i> , page C252.

Options	Price	Required to Specify
Surface Materials <ul style="list-style-type: none"> Paint price group 1 Paint price group 2 	No cost +\$ 25	Specify paint color number. Specify paint color number.
Brackets <ul style="list-style-type: none"> Enhanced off-module Montage 	Off-module brackets for horizontal slot patterned panels +\$130	Specify with off-module bracket-enhanced off-module Montage.

Specification Information				
Dimensions			Style	Base
D	W	H	Number	Price
:	:	:	:	:
:	:	:	:	:

L-Shelves				
14¼"	30"	15"	KLSHF30 _	\$264
14¼"	36"	15"	KLSHF36 _	\$280
14¼"	42"	15"	KLSHF42 _	\$315
14¼"	45"	15"	KLSHF45 _	\$320
14¼"	48"	15"	KLSHF48 _	\$320
:	:	:	:	:

Montage

Bracket Application Rules

for Curved Front Bin and L-Shelf

Basic Brackets

Basic brackets are used to mount bins and shelves to panels with vertical slot patterns. Basic attachment brackets push bins and shelves $\frac{1}{4}$ " from frame.

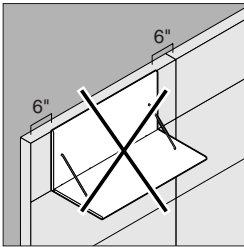

Width of overhead bin or shelf must match or be wider than the width of the panel or panels that it is attached to.

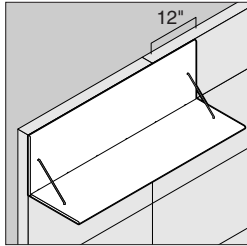

Basic attachment brackets install in panel seams and allow bins and shelves that are wider to be attached. Total width of bin or shelf can extend 12" beyond the bracket on one side.

Full Off-Module Brackets

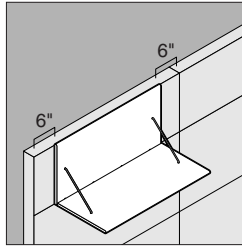

Full off-module brackets, optional, accommodate off-module installations of bins and shelves on panels with horizontal slot patterns. Enhanced off-module Montage frames can support full off-module brackets. Full off-module brackets push bins and shelves $\frac{1}{2}$ " from frame.

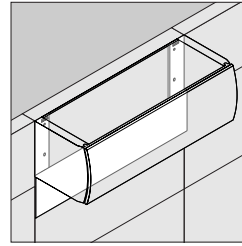

Coverplates are included with brackets for use on enhanced off-module Montage frames. Coverplate extends below the bin or shelf to conceal the bracket. Height of coverplate for enhanced off-module Montage is $6\frac{1}{2}$ ".

Enhanced off-module Montage frames have horizontal slot patterns and must be specified for full off-module Montage configurations.

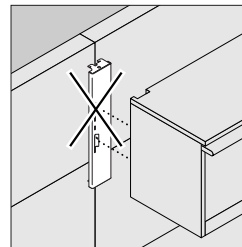

Off-module brackets cannot span a vertical or joint where two frames come together on enhanced off-module Montage frame. Shift bin or shelf to avoid joint.

Add-On Shelves

for Curved Front Bin and L-Shelf

SIN 711.1

Stationary Shelves

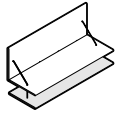

Tip: Stationary shelf hangs 5½" from the bottom of curved front bins and L-shelves. Specify the same width as corresponding bin or L-shelf.

Tip: Shelf is steel with molded endcaps.

Standard Includes		Required to Specify	
-------------------	--	---------------------	--

- Shelf: paint price group 1
- Attachment rods: shiny chrome

- 1 Style number
- 2 Paint color number for shelf
- 3 Options, if selected (see below)
- ▶ See *Surface Materials*, page C252.

Options	Price	Required to Specify
---------	-------	---------------------

Surface Materials

- Paint price group 1
- Paint price group 2

No cost
+\$13

Specify paint color number.
Specify paint color number.

Related Products

- Curved front bins
- L-shelf

- ▶ Pages C157–C158
- ▶ Page C159

Specification Information

Dimensions		Style	Base
D	W	Number	Price
14"	30"	KSSH30	\$144
14"	36"	KSSH36	\$158
14"	42"	KSSH42	\$172
14"	45"	KSSH45	\$186
14"	48"	KSSH48	\$186

Display Shelf

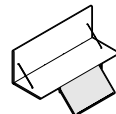

Tip: Display shelf hangs 5½" from the bottom of curved front bins and L-shelves.

Standard Includes		Required to Specify	
-------------------	--	---------------------	--

- Shelf: paint price group 1
- Attachment rods: shiny chrome

- 1 Style number
- 2 Paint color number for shelf
- 3 Options, if selected (see below)
- ▶ See *Surface Materials*, page C252.

Options	Price	Required to Specify
---------	-------	---------------------

Surface Materials

- Paint price group 1
- Paint price group 2

No cost
+\$13

Specify paint color number.
Specify paint color number.

Related Products

- Curved front bins
- L-shelf

- ▶ Pages C157–C158
- ▶ Page C159

Specification Information

Dimensions		Style	Base
D	W	Number	Price
13"	25"	KDISPLAY24	\$186

Accessories

for Curved Front Bin and L-Shelf

SIN 711.1

Dividers

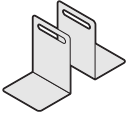

Standard Includes	Required to Specify
<ul style="list-style-type: none"> Package of two or twenty dividers: 6695 Midnight only 	Style number

Specification Information

•Style Number	•Price
KDIV02	\$ 19
KDIV20	\$185

ADA Pull

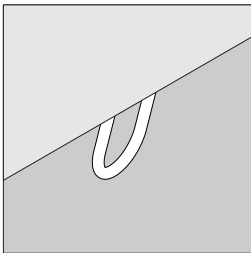

Standard Includes	Required to Specify
<ul style="list-style-type: none"> ADA pull: 6695 Midnight only 	Style number

Specification Information

•Style Number	•Price
KPULL	\$34

Ganging Brackets

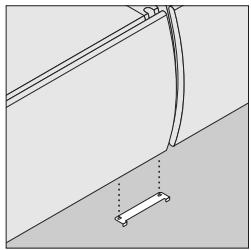

Standard Includes	Required to Specify
<ul style="list-style-type: none"> Package of one or twenty ganging brackets: all paint price groups 	1 Style number number 2 Paint color number ▶ See <i>Surface Materials</i> , page C252.

Specification Information

•Style Number	•Quantity	•Price
KGANG	1	\$ 12
KGANG20	20	\$200

Montage Fixed Pedestals

with On-Module Filler

SIN 711.1



Tip: You can also use Context mobile pedestals and lateral files beneath Montage worksurfaces.
 ▶ See the *Context Specification Guide*.

Tip: Pedestals are for use in on-module configurations only.

Tip: Standard pedestals can be converted to off-module pedestals by ordering a standard service parts package through Service Parts.

Standard Includes		Required to Specify	
<ul style="list-style-type: none"> • Pedestal: paint price group 1 • Waterfall or rod pulls • Full drawer interiors: black only <ul style="list-style-type: none"> – Full-depth drawer body – Full-extension drawer suspensions – One pencil tray per box/box/file and box drawer dividers • Lock, keyed random: 9201 Polished Chrome • Four adjustable leveling glides • On-module filler 		<ul style="list-style-type: none"> 1 Style number 2 Paint color number for pedestal 3 Color number for drawer pulls 4 Options, if selected (see below) ▶ See <i>Surface Materials</i>, page C252. 	

Options	Price	Required to Specify
Surface Materials	<ul style="list-style-type: none"> • Paint price group 1: No cost • Paint price group 2: +\$38 • Paint price group 3: +\$65 	Specify paint color number. Specify paint color number. Specify paint color number.
Pulls	<p>Waterfall and rod pulls</p> <ul style="list-style-type: none"> • Paint: No cost • Plated metal: +\$13 per drawer 	Specify paint color number. Specify plated metal color number.
Filler	<ul style="list-style-type: none"> • No filler: -\$25 	Specify <i>with no filler</i> .
Lock and Keying	<p>Lock</p> <ul style="list-style-type: none"> • Ember Chrome: No cost • No lock: -\$50 <p>Individual locking drawers</p> <ul style="list-style-type: none"> • File/file pedestals only: +\$95 <p>Keying</p> <ul style="list-style-type: none"> • Factory- and field installed keying 	Specify <i>with 9250 Ember Chrome lock</i> . Specify <i>with no lock</i> . Specify <i>with individual drawer lock</i> . ▶ Page C262

Specification Information

Depth	Style Number	Base Price
:	:	:

Two Box Drawers and One File Drawer

Waterfall Pulls		
23½"	ZU24BBFLW	\$640
29½"	ZU30BBFLW	\$673
:	:	:
Rod Pulls		
23½"	ZU24BBFLR	\$640
29½"	ZU30BBFLR	\$673
:	:	:

Two File Drawers

Waterfall Pulls		
23½"	ZU24FFLW	\$578
29½"	ZU30FFLW	\$609
:	:	:
Rod Pulls		
23½"	ZU24FFLR	\$578
29½"	ZU30FFLR	\$609
:	:	:

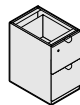

Montage Fixed Pedestals

with Off-Module Filler

SIN 711.1



Tip: Off-module pedestals are for use in off-module configurations only.

Tip: Off-module pedestals can be converted to standard pedestals by ordering a standard bracket package through Service Parts.

Standard Includes	Required to Specify
<ul style="list-style-type: none"> • Pedestal: paint price group 1 • Waterfall or rod pulls • Full drawer interiors: black only <ul style="list-style-type: none"> – Full-depth drawer body – Full-extension drawer suspensions – One pencil tray per box/box/file and box drawer dividers • Lock, keyed random: 9201 Polished Chrome • Four adjustable leveling glides • Off-module filler and interface brackets 	<ol style="list-style-type: none"> 1 Style number 2 Paint color number for pedestal 3 Color number for drawer pulls 4 Options, if selected (see below) <p>▶ See <i>Surface Materials</i>, page C252.</p>

Options	Price	Required to Specify
Surface Materials <ul style="list-style-type: none"> • Paint price group 1 • Paint price group 2 • Paint price group 3 	No cost +\$38 +\$65	Specify paint color number. Specify paint color number. Specify paint color number.
Pulls <ul style="list-style-type: none"> • Paint • Plated metal 	Waterfall and rod pulls No cost +\$13 per drawer	Specify paint color number. Specify plated metal color number.
Filler <ul style="list-style-type: none"> • No filler 	–\$25	Specify <i>with no filler</i> .
Lock and Keying <ul style="list-style-type: none"> • Ember Chrome • No lock 	No cost –\$50	Specify <i>with 9250 Ember Chrome lock</i> . Specify <i>with no lock</i> .
<ul style="list-style-type: none"> • File/file pedestals only 	+\$95	Specify <i>with individual drawer lock</i> .
Keying <ul style="list-style-type: none"> • Factory- and field installed keying 		▶ Page C262

Specification Information

Depth	Style Number	Base Price

Two Box Drawers and One File Drawer

Waterfall Pulls

23½"	ZU24BBFLWOM	\$640
29½"	ZU30BBFLWOM	\$673

Rod Pulls

23½"	ZU24BBFLROM	\$640
29½"	ZU30BBFLROM	\$673

Two File Drawers

Waterfall Pulls

23½"	ZU24FFLWOM	\$578
29½"	ZU30FFLWOM	\$609

Rod Pulls

23½"	ZU24FFLROM	\$578
29½"	ZU30FFLROM	\$609

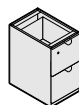
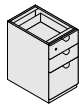

Specifying Montage Wood Selections

► For more detailed product information, see the *Montage Solutions Specification Guide* or consult your Steelcase dealer.

Frame-Supported Worksurfaces and Table

Straight Worksurfaces (SIN 711.1)	C166
Transition Worksurfaces (SIN 711.1)	C168
Corner Worksurfaces (SIN 711.1)	C170
Cornerstone Worksurfaces (SIN 711.1)	C171
Spanner Worksurfaces (SIN 711.1)	C172
Bullet Top Worksurfaces (SIN 711.1)	C174
Extended T-Shape End Panels (SIN 711.1)	C176
P-Top Worksurfaces (SIN 711.1)	C178
Sock Top Worksurfaces (SIN 711.1)	C180
Scoop Top Worksurfaces (SIN 711.1)	C182
Curved-Front Transaction Worksurfaces (SIN 711.1)	C184
Worksurface Supports (SIN 711.1)	C185
Tether Table (SIN 711.1)	C189

Shells

Freestanding Desk Shells (SIN 711.1)	C190
Return Shells (SIN 711.1)	C192
Bridge Shells (SIN 711.1)	C194
Credenza Shells (SIN 711.1)	C196
Freestanding Corner Worksurface Shells (SIN 711.1)	C198
Freestanding Cornerstone Worksurface Shells (SIN 711.1)	C199
Shell Components (SIN 711.1)	C200

Storage

Pedestals (SIN 711.1)	C206
Metal Pedestals with Wood Drawer Fronts and Off-Module Filler (SIN 711.1)	C208
Metal Pedestals with Wood Drawer Fronts (SIN 711.1)	C210
Freestanding Lateral Files (SIN 711.1)	C212
Mobile Pedestal (SIN 711.1)	C214
Smart Mobile Pedestal (SIN 711.1)	C216
Smart Mobile Pedestal with Open Shelves (SIN 711.1)	C217
Standing-Height Mobile Cabinet (SIN 711.1)	C218
Overhead Storage Shelves (SIN 711.1)	C220
Organizer Shelves (SIN 711.1)	C221
Overhead Storage Cabinets (SIN 711.1)	C222
Service Modules (SIN 711.1)	C223
Service Module Tackboards (SIN 711.1)	C224
Vertical Cabinets (SIN 711.1)	C226
Worksurfaces for Use Above 50½"H Lateral File (SIN 711.1)	C228
Bookcases (SIN 711.1)	C229

Wood Top Caps (SIN 711.1) **C230**

Wood Vertical End Trim (SIN 711.1) **C231**

Power and Communication Accessories (SIN 711.1) **C232**

Wood Veneer Straight Worksurfaces

SIN 711.1

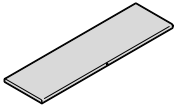

Standard Includes	Required to Specify
-------------------	---------------------

- Worksurface: wood veneer
- Edge profile: wood, except square and radius profiles which are wood veneer

- 1 Style number with appropriate edge-profile suffix
▶ See edge-profile suffixes at bottom of page.
- 2 Wood veneer color number for worksurface
- 3 Options, if selected (see below)
▶ See *Surface Materials*, page C252.

Surface Materials	Options	Price	Required to Specify
-------------------	---------	-------	---------------------

- | | | | |
|-------------------|--------------------------|-----------------|---|
| Surface Materials | • Full-fill finish | Prices at right | Specify with <i>full-fill finish</i> and select wood color number. |
| | • Customiz stain on wood | Prices at right | Specify with <i>Customiz stain</i> .
▶ See <i>Surface Materials Reference Manual</i> . |

Lock and Keying	Options	Price	Required to Specify
-----------------	---------	-------	---------------------

- | | | | |
|-----------------|--|--------|--------------------------------------|
| Lock and Keying | Lock, keyed random: 9250 Ember Chrome | | |
| | • Available only on worksurfaces with
– Square profile (Q)
– Radius profile (R)
– Double Bullnose profile (D) | +\$116 | Add suffix L to style number. |

Alternative lock color on worksurface with locks

- | | | |
|-------------------|---------|---|
| • Polished Chrome | No cost | Specify with <i>9201 Polished Chrome lock</i> . |
| • Antique Bronze | No cost | Specify with <i>9230 Antique Bronze lock</i> . |

Keying

- | | |
|---------------------------------------|-------------|
| • Factory- and field installed keying | ▶ Page C262 |
|---------------------------------------|-------------|

Cable Management	Options	Price	Required to Specify
------------------	---------	-------	---------------------

- | | | | |
|------------------|--|-------------|--|
| Cable Management | Three-piece grommets | | |
| | • Available on all worksurface depths: plastic | +\$ 25 each | Rear left: <i>E91RL4</i> and color number.
Rear right: <i>E91RR6</i> and color number.
Rear center: <i>E91RC1</i> and color number.
Center left: <i>E91CL9</i> and color number.
Center right: <i>E91CR1</i> and color number.
Center center: <i>E91CC6</i> and color number.
Front left: <i>E91FL8</i> and color number.
Front right: <i>E91FR0</i> and color number.
Front center: <i>E91FC5</i> and color number. |

4"-square grommets

- | | | |
|--|--------|------------------------------|
| • Centered along back edge of worksurface: black plastic only | +\$ 25 | Specify with <i>WWTPC</i> . |
| • Left- and right-hand side of worksurface: black plastic only | +\$ 50 | Specify with <i>WWTPLR</i> . |

Channel grommet

- | | | |
|---|--------|-----------------------------|
| • Available on back of worksurfaces: black plastic only | +\$250 | Specify with <i>WWTPF</i> . |
|---|--------|-----------------------------|

▶ Options, continued on next page



Edge Profile Location

Tip: Your specification is not complete until you add a suffix to define the worksurface's edge profile.

Tip: On a wood veneer straight worksurface, the bullnose (B) profile is not available.

Edge Profiles

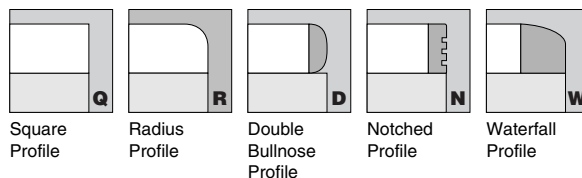

► Options continued from previous page

Options	Price	Required to Specify
Supports <ul style="list-style-type: none"> • End panels • Off-module end panels • Cantilevers • Side-support brackets • Pedestals 		<ul style="list-style-type: none"> ▶ Page C185 ▶ Page C185 ▶ Page C186 ▶ Page C187 ▶ Page C206
Related Products <ul style="list-style-type: none"> • Worksurface wiring and cabling • Side-support brackets • Off-module worksurface brackets • Off-module tie plates 		<ul style="list-style-type: none"> ▶ Page C143 ▶ Page C187 ▶ Page C188 ▶ Page C188

Specification Information

Width	Style Number	Base Price			Option
		Profile Q and R	Profile D and N	Profile W	(Add \$ to Base Price)
					Full-Fill Finish or Customiz Stain

24"D

24"	ZEW2424W__	\$270	\$ 317	\$ 333	+\$24
30"	ZEW2430W__	\$311	\$ 380	\$ 393	+\$24
36"	ZEW2436W__	\$320	\$ 394	\$ 406	+\$41
42"	ZEW2442W__	\$427	\$ 504	\$ 518	+\$41
48"	ZEW2448W__	\$462	\$ 549	\$ 556	+\$41
54"	ZEW2454W__	\$503	\$ 633	\$ 650	+\$41
60"	ZEW2460W__	\$578	\$ 699	\$ 719	+\$60
66"	ZEW2466W__	\$594	\$ 707	\$ 730	+\$60
72"	ZEW2472W__	\$603	\$ 749	\$ 773	+\$60
90"	ZEW2490W__	\$786	\$ 978	\$1024	+\$60

30"D

24"	ZEW3024W__	\$356	\$ 438	\$ 452	+\$24
30"	ZEW3030W__	\$366	\$ 450	\$ 465	+\$41
36"	ZEW3036W__	\$378	\$ 468	\$ 483	+\$41
42"	ZEW3042W__	\$510	\$ 641	\$ 664	+\$41
48"	ZEW3048W__	\$570	\$ 679	\$ 698	+\$41
54"	ZEW3054W__	\$604	\$ 713	\$ 738	+\$60
60"	ZEW3060W__	\$670	\$ 819	\$ 846	+\$60
66"	ZEW3066W__	\$672	\$ 843	\$ 875	+\$60
72"	ZEW3072W__	\$757	\$ 945	\$ 977	+\$60
90"	ZEW3090W__	\$895	\$1134	\$1174	+\$60

Wood Veneer Transition Worksurfaces

SIN 711.1

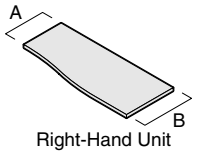
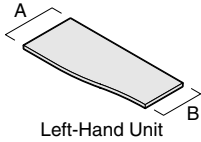

Tip: You can specify only one type of cable-management option on a worksurface.

Tip: If a plastic color is not specified for a grommet with color choices, 6000 Black plastic will be provided.

Tip: Transition worksurfaces are not available with central lock.

Tip: When mounting worksurfaces off module, you must use a combination of on-module and off-module supports.

Tip: Grommets must be used for cable drops.

Standard Includes	Required to Specify
-------------------	---------------------

- Worksurface: wood veneer
- Edge profile: wood, except square profile which is wood veneer

- 1 Style number with appropriate edge-profile suffix
▶ See edge-profile suffixes at bottom of page.
- 2 Wood veneer color number for worksurface
- 3 Options, if selected (see below)
▶ See *Surface Materials*, page C252.

Options	Price	Required to Specify
---------	-------	---------------------

Surface Materials	• Full-fill finish	+\$ 60	Specify with <i>full-fill finish</i> and select wood color number. Specify with <i>Customiz stain</i> . ▶ See <i>Surface Materials Reference Manual</i> .
	• Customiz stain on wood	+\$ 60	

Cable Management	Three-piece grommets	Price	Required to Specify
------------------	----------------------	-------	---------------------

Cable Management	• Available on all worksurface depths: plastic	+\$ 25 each	Rear left: <i>E91RL4</i> and color number. Rear right: <i>E91RR6</i> and color number. Rear center: <i>E91RC1</i> and color number. Center left: <i>E91CL9</i> and color number. Center right: <i>E91CR1</i> and color number. Center center: <i>E91CC6</i> and color number.
-------------------------	--	-------------	--

4"-square grommets

• Centered along back edge of worksurface: black plastic only	+\$ 25	Specify with <i>WWTPC</i> .
• Left- and right-hand side of worksurface: black plastic only	+\$ 50	Specify with <i>WWTPLR</i> .

Channel grommet

• Available on back of worksurfaces: black plastic only	+\$250	Specify with <i>WWTPF</i> .
---	--------	-----------------------------

Supports	Options	Required to Specify
----------	---------	---------------------

Supports	• End panels	▶ Page C185
	• Off-module end panels	▶ Page C185
	• Cantilevers	▶ Page C186
	• Side-support brackets	▶ Page C187
	• Flush-mount bracket	▶ Page C187
	• Pedestals	▶ Page C206

Related Products	Options	Required to Specify
------------------	---------	---------------------

Related Products	• Worksurface wiring and cabling	▶ Page C143
	• Side-support brackets	▶ Page C187
	• Off-module worksurface brackets	▶ Page C188
	• Off-module tie plates	▶ Page C188



Tip: Your specification is not complete until you add a suffix to define the worksurface's edge profile.

Tip: On transition worksurfaces, the radius (R) profile is not available because the edge is curved.

Edge Profiles

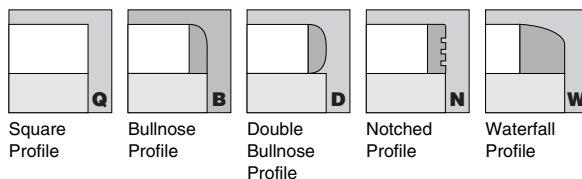

Specification Information

Dimensions			Style Number	Base Price		
A	B	W		Profile Q	Profile B, D, and N	Profile W

Left-Hand Units

30"	24"	60"	ZEWTL3060W	\$609	\$ 671	\$ 736
30"	24"	66"	ZEWTL3066W	\$687	\$ 756	\$ 804
30"	24"	72"	ZEWTL3072W	\$765	\$ 841	\$ 895
30"	24"	90"	ZEWTL3090W	\$986	\$1086	\$1194
:	:	:	:	:	:	:

Right-Hand Units

24"	30"	60"	ZEWTR3060W	\$609	\$ 671	\$ 736
24"	30"	66"	ZEWTR3066W	\$687	\$ 756	\$ 804
24"	30"	72"	ZEWTR3072W	\$765	\$ 841	\$ 895
24"	30"	90"	ZEWTR3090W	\$986	\$1086	\$1194
:	:	:	:	:	:	:

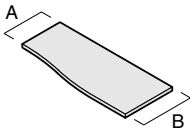
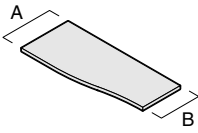

Montage

Wood Veneer Corner Worksurfaces

SIN 711.1

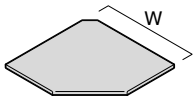

Tip: You can specify only one type of cable-management option on a worksurface.

Tip: If a plastic color is not specified for a grommet with color choices, 6000 Black plastic will be provided.

Tip: When mounting worksurfaces off module, you must use a combination of on-module and off-module supports.

Standard Includes

- Worksurface: wood veneer
- Edge profile: wood, except square and radius profiles which are wood veneer

Required to Specify

- 1 Style number with appropriate edge-profile suffix
▶ See edge-profile suffixes at bottom of page.
- 2 Wood veneer color number for worksurface
- 3 Options, if selected (see below)
▶ See *Surface Materials*, page C252.

Options

Options	Price	Required to Specify
Surface Materials		
• Full-fill finish	+\$41	Specify with <i>full-fill finish</i> and select wood color number.
• Customiz stain on wood	+\$41	Specify with <i>Customiz stain</i> . ▶ See <i>Surface Materials Reference Manual</i> .

Cable Management	Three-piece grommets		
	• Available on all worksurfaces: plastic	+\$25 each	Rear: E91C2 and plastic color number.

Supports	<ul style="list-style-type: none"> • End panels • Off-module end panels • Cantilevers • Corner worksurface bracket • Side-support brackets • Off-module worksurface brackets • Off-module tie plates • End-of-run cantilevers 		<ul style="list-style-type: none"> ▶ Page C185 ▶ Page C185 ▶ Page C186 ▶ Page C187 ▶ Page C187 ▶ Page C188 ▶ Page C188 ▶ Page C188
-----------------	---	--	--

Specification Information

Dimensions		Style Number	Base Price		
D	W		Profile Q and R	Profile D and N	Profile W
24"	42"	ZEWC2442W__	\$620	\$682	\$738
24"	48"	ZEWC2448W__	\$630	\$693	\$750
30"	42"	ZEWC3042W__	\$657	\$723	\$782
30"	48"	ZEWC3048W__	\$667	\$734	\$794

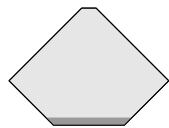

Edge Profile Location

Tip: Your specification is not complete until you add a suffix to define the work-surface's edge profile.

Tip: On wood veneer corner worksurfaces, the bullnose (B) profile is not available.

Edge Profiles

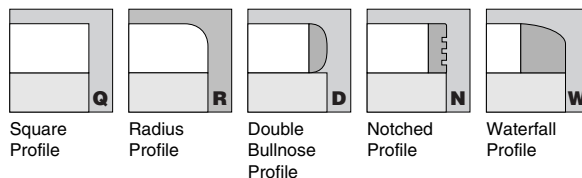

Wood Veneer Cornerstone Worksurfaces

SIN 711.1

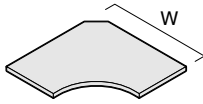

Tip: When mounting work-surfaces off module, you must use a combination of on-module and off-module supports.

Standard Includes

- Worksurface: wood veneer
- Edge profile: wood, except square profile which is wood veneer

Required to Specify

- 1 Style number with appropriate edge-profile suffix
 - ▶ See edge-profile suffixes at bottom of page.
- 2 Wood veneer color number for worksurface
- 3 Options, if selected (see below)
 - ▶ See *Surface Materials*, page C252.

Options

Options	Price	Required to Specify
Surface Materials		
• Full-fill finish	+\$41	Specify <i>with full-fill finish</i> and select wood color number.
• Customiz stain on wood	+\$41	Specify <i>with Customiz stain</i> . ▶ See <i>Surface Materials Reference Manual</i> .

Supports	Price	Required to Specify
• End panels		▶ Page C185
• Off-module end panels		▶ Page C185
• Cantilevers		▶ Page C186
• Corner worksurface bracket		▶ Page C187
• Side-support brackets		▶ Page C187
• Off-module worksurface brackets		▶ Page C188
• Off-module tie plates		▶ Page C188
• End-of-run cantilevers		▶ Page C188

Specification Information

Dimensions D W	Style Number	Base Price		
		Profile Q and R	Profile D and N	Profile W
24" 42"	ZEWCS2442W _	\$719	\$791	\$856
24" 48"	ZEWCS2448W _	\$731	\$804	\$870
30" 42"	ZEWCS3042W _	\$762	\$838	\$907
30" 48"	ZEWCS3048W _	\$774	\$851	\$921

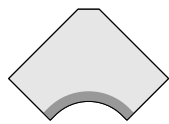

Edge Profile Location

Tip: Your specification is not complete until you add a suffix to define the work-surface's edge profile.

Tip: On cornestone work-surfaces, the radius (R) profile is not available because the edge is curved.

Edge Profiles

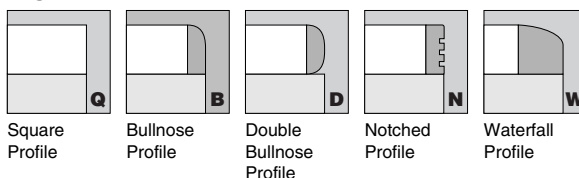

Wood Veneer Spanner Worksurfaces

SIN 711.1

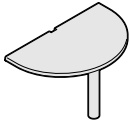

Tip: You can specify only one type of cable-management option on a work surface.

Tip: If a plastic color is not specified for a grommet with color choices, 6000 Black plastic will be provided.

Tip: Grommets must be used for cable drops.

Tip: When mounting work-surfaces off module, you must use a combination of on-module and off-module supports.

Tip: 51" wide spanner-style tables are used with two 24"D work surfaces.

Tip: 63" wide spanner-style tables are used with two 30"D work surfaces.

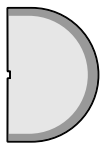

Edge Profile Location

Tip: Your specification is not complete until you add a suffix to define the work surface's edge profile.

Tip: On spanner work-surfaces, the radius (R) profile is not available because the edge is curved.

Standard Includes	Required to Specify
-------------------	---------------------

- Worksurface: wood veneer
- Support column: all paint price groups
- Edge profile: wood, except square profile which is wood veneer

- 1 Style number with appropriate edge-profile suffix
▶ See edge-profile suffixes at bottom of page.
- 2 Wood veneer color number for work surface
- 3 Options, if selected (see below)
▶ See *Surface Materials*, page C252.

Surface Materials	Options	Price	Required to Specify
-------------------	---------	-------	---------------------

Surface Materials	• Full-fill finish	+\$ 60	Specify with <i>full-fill finish</i> and select wood color number.
	• Customiz stain on wood	+\$ 60	Specify with <i>Customiz stain</i> . ▶ See <i>Surface Materials Reference Manual</i> .

Support column

- Paint No cost
- Polished Chrome +\$ 99
- Antique Bronze +\$131

Select paint color number for support column.
Specify with *9201 Polished Chrome support column*.
Specify with *9230 Antique Bronze support column*.

Cable Management	Three-piece grommet	Price	Required to Specify
------------------	---------------------	-------	---------------------

- Centered on straight end 2" from edge: plastic +\$ 25

Specify with *E91RET4* and select plastic color number.

4" square grommet

- Centered on straight end 2" from edge: black plastic only +\$ 25

Specify with *WWTPC*.

Supports	Shared cantilevers	Price	Required to Specify
----------	--------------------	-------	---------------------

- Two shared cantilevers (one left and one right) must be used to support a spanner work surface.
- Adjustable column

▶ Page C186

▶ Page C139

Specification Information

• Dimensions		• Style Number	• Base Price		
D	W		Profile Q	Profile B, D, and N	Profile W
36"	51"	ZEWSP3651W__	\$1499	\$1680	\$1746
36"	63"	ZEWSP3663W__	\$1571	\$1760	\$1831

Edge Profiles

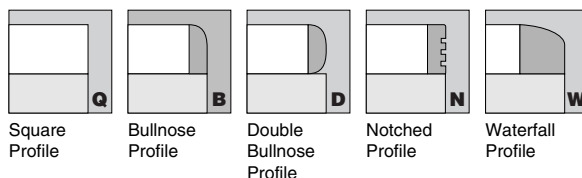

Wood Veneer Bullet Top Worksurfaces

SIN 711.1

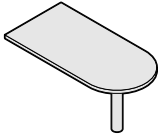

Standard Includes	Required to Specify
<ul style="list-style-type: none"> • Worksurface: wood veneer • Height-adjustable support column: all paint price groups • Edge profile: wood, except square profile which is wood veneer 	<p>1 Style number with appropriate edge-profile suffix</p> <p>▶ See edge-profile suffixes at bottom of page.</p> <p>2 Wood veneer color number for worksurface</p> <p>3 Options, if selected (see below)</p> <p>▶ See <i>Surface Materials</i>, page C252.</p>

Surface Materials	Options	Price	Required to Specify
	• Full-fill finish	+\$ 84	Specify with <i>full-fill finish</i> and select wood color number.
	• Customiz stain on wood	+\$ 84	Specify with <i>Customiz stain</i> . ▶ See <i>Surface Materials Reference Manual</i> .
	Support column		
	• Paint	No cost	Select paint color number for support column.
	• Polished Chrome	+\$ 99	Specify with <i>9201 Polished Chrome support column</i> .
	• Antique Bronze	+\$131	Specify with <i>9230 Antique Bronze support column</i> .

Cable Management	Options	Price	Required to Specify
	Three-piece grommet		
	• Centered on straight end 3" from edge: plastic	+\$ 25	Specify with <i>E91RET4</i> and select plastic color number.
	4" square grommet		
	• Centered on straight end 2" from edge: black plastic only	+\$ 25	Specify with <i>WWTPC</i> .

Supports	Options	Required to Specify
	Frame-supported application	
	• End panels	▶ Page C185
	• Cantilevers	▶ Page C186
	• Shared cantilevers	▶ Page C186
	• Off-module worksurface brackets	▶ Page C188
	Worksurface-supported application	
	• Adjustable column	▶ Page C139
	• Flush-mount bracket	▶ Page C187
	• Side-support brackets	▶ Page C187
	• Off-module tie plates	▶ Page C188

Tip: Grommets must be used for cable drops.

Tip: You can specify only one type of cable-management option on a worksurface.

Tip: If a plastic color is not specified for a grommet with color choices, 6000 Black plastic will be provided.

Tip: When mounting work-surfaces off module, you must use a combination of on-module and off-module supports.



Edge Profile Location

Tip: Your specification is not complete until you add a suffix to define the work-surface's edge profile.

Tip: On bullet top worksur-faces, the radius (R) profile is not available because the edge is curved.

Edge Profiles

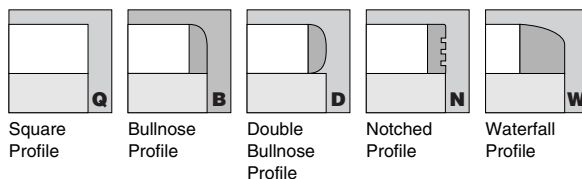

Specification Information

Dimensions		Style Number	Base Price		
D	L		Profile Q	Profile B, D, and N	Profile W
30"	60"	ZEWB3060W __	\$ 895	\$1170	\$1200
30"	66"	ZEWB3066W __	\$ 934	\$1206	\$1253
30"	72"	ZEWB3072W __	\$1008	\$1303	\$1353
30"	90"	ZEWB3090W __	\$1134	\$1466	\$1521
36"	60"	ZEWB3660W __	\$ 952	\$1231	\$1277
36"	66"	ZEWB3666W __	\$ 991	\$1282	\$1312
36"	72"	ZEWB3672W __	\$1067	\$1380	\$1433
36"	90"	ZEWB3690W __	\$1238	\$1599	\$1661
:	:	:	:	:	:

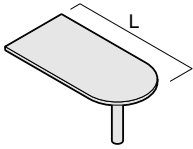

Wood Veneer Extended T-Shape End Panels

for Use with Bullet Top and P-Top Worksurfaces

SIN 711.1

Tip: Worksurface must be connected to a bridge, return, or adjoining work-surface to form an L- or U-shaped configuration and to provide proper stability. Additional attachment hardware may need to be ordered.

Tip: 30"D unit will be recessed on the visitor side 8⁷/₈".

Tip: 36"D unit will be recessed on the visitor side 13⁷/₈".

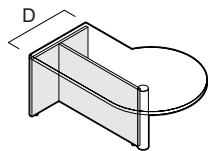
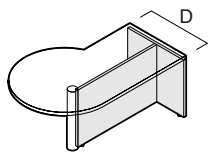
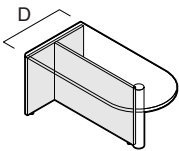

Standard Includes	Required to Specify
-------------------	---------------------

- | | |
|---|--|
| • Extended T-shape end panel: wood veneer | 1 Style number with appropriate edge-profile suffix
2 Wood veneer color number for end panel
3 Options, if selected (see below)
▶ See <i>Surface Materials</i> , page C252. |
|---|--|

Options	Price	Required to Specify
---------	-------	---------------------

- | | | |
|--------------------------|--------------------------|---|
| Surface Materials | • Customiz stain on wood | Prices below
Specify with <i>Customiz stain</i> .
▶ See <i>Surface Materials Reference Manual</i> . |
|--------------------------|--------------------------|---|

Specification Information

• Dimensions		• Fits Bullet Top Worksurface Width	• Style Number	• Base Price	• Option (Add \$ to Base Price) Customiz Stain
D	W				

For Use with Bullet Top Worksurfaces

30"	41 ¹¹ / ₁₆ "	60"	ZETP3060W	\$ 780	+\$120
30"	47 ¹¹ / ₁₆ "	66"	ZETP3066W	\$ 811	+\$144
30"	53 ¹¹ / ₁₆ "	72"	ZETP3072W	\$ 889	+\$167
30"	71 ¹¹ / ₁₆ "	90"	ZETP3090W	\$1024	+\$195
36"	41 ¹¹ / ₁₆ "	60"	ZETP3660W	\$ 807	+\$120
36"	47 ¹¹ / ₁₆ "	66"	ZETP3666W	\$ 837	+\$144
36"	53 ¹¹ / ₁₆ "	72"	ZETP3672W	\$ 916	+\$167
36"	71 ¹¹ / ₁₆ "	90"	ZETP3690W	\$1050	+\$195

For Use with P-Top Worksurfaces

Left-Hand P-Top Worksurfaces

30"	41 ³ / ₄ "	66"	ZETPL3066W	\$773	+\$144
30"	47 ³ / ₄ "	72"	ZETPL3072W	\$850	+\$167
36"	41 ³ / ₄ "	66"	ZETPL3666W	\$829	+\$144
36"	47 ³ / ₄ "	72"	ZETPL3672W	\$875	+\$167

Right-Hand P-Top Worksurfaces

30"	41 ³ / ₄ "	66"	ZETPR3066W	\$773	+\$144
30"	47 ³ / ₄ "	72"	ZETPR3072W	\$850	+\$167
36"	41 ³ / ₄ "	66"	ZETPR3666W	\$829	+\$144
36"	47 ³ / ₄ "	72"	ZETPR3672W	\$875	+\$167

Wood Veneer Extended T-Shape
End Panels for Use with Bullet
Top and P-Top Worksurfaces

SIN 711.1

Wood Veneer P-Top Worksurfaces

SIN 711.1

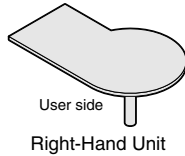
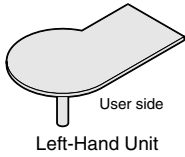

Tip: Grommets must be used for cable drops.

Tip: You can specify only one type of cable-management option on a worksurface.

Tip: If a plastic color is not specified for a grommet with color choices, 6000 Black plastic will be provided.

Tip: When mounting worksurfaces off module, you must use a combination of on-module and off-module supports.

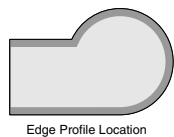

Tip: Your specification is not complete until you add a suffix to define the worksurface's edge profile.

Tip: On P-top worksurfaces, the radius (R) profile is not available because the edge is curved.

Standard Includes	Required to Specify
-------------------	---------------------

- Worksurface: wood veneer
- Height-adjustable support column: all paint price groups
- Edge profile: wood, except square profile which is wood veneer

- 1 Style number with appropriate edge-profile suffix
▶ See edge-profile suffixes at bottom of page.
- 2 Wood veneer color number for worksurface
- 3 Options, if selected (see below)
▶ See *Surface Materials*, page C252.

Surface Materials	Options	Price	Required to Specify
-------------------	---------	-------	---------------------

- | | | | |
|-------------------|--------------------------|--------|---|
| Surface Materials | • Full-fill finish | +\$ 84 | Specify with <i>full-fill finish</i> and select wood color number. |
| | • Customiz stain on wood | +\$ 84 | Specify with <i>Customiz stain</i> .
▶ See <i>Surface Materials Reference Manual</i> . |

Support column	Options	Price	Required to Specify
----------------	---------	-------	---------------------

- | | | | |
|----------------|-------------------|---------|---|
| Support column | • Paint | No cost | Select paint color number for support column. |
| | • Polished Chrome | +\$ 99 | Specify with <i>9201 Polished Chrome support column</i> . |
| | • Antique Bronze | +\$131 | Specify with <i>9230 Antique Bronze support column</i> . |

Cable Management	Three-piece grommet	Price	Required to Specify
------------------	---------------------	-------	---------------------

- | | | | |
|------------------|--|--------|--|
| Cable Management | • Centered on straight end 3" from edge: plastic | +\$ 25 | Specify with <i>E91RET4</i> and select plastic color number. |
|------------------|--|--------|--|

Cable Management	4" square grommets	Price	Required to Specify
------------------	--------------------	-------	---------------------

- | | | | |
|------------------|---|--------|-----------------------------|
| Cable Management | • Centered on straight end 2" from edge: black plastic only | +\$ 25 | Specify with <i>WWTPC</i> . |
|------------------|---|--------|-----------------------------|

Supports	Frame-supported application	Page
----------	-----------------------------	------

- | | | |
|----------|-----------------------------------|-------------|
| Supports | • Cantilevers | ▶ Page C186 |
| | • Shared cantilevers | ▶ Page C186 |
| | • Side-support brackets | ▶ Page C187 |
| | • Off-module worksurface brackets | ▶ Page C188 |

Supports	Worksurface-supported application	Page
----------	-----------------------------------	------

- | | | |
|----------|-----------------------|-------------|
| Supports | • Adjustable column | ▶ Page C139 |
| | • Flush-mount bracket | ▶ Page C187 |

Edge Profiles

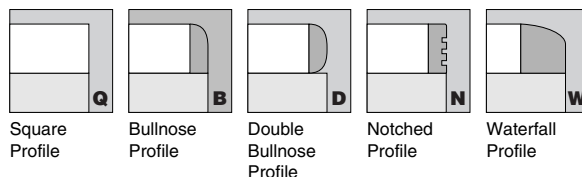

Specification Information

Dimensions		Style Number	Base Price		
D	L		Profile Q	Profile B, D, and N	Profile W

Left-Hand Units

30"	66"	ZEWPL3066W	\$1074	\$1386	\$1439
30"	72"	ZEWPL3072W	\$1159	\$1497	\$1554
36"	66"	ZEWPL3666W	\$1186	\$1534	\$1591
36"	72"	ZEWPL3672W	\$1230	\$1590	\$1651
:	:	:	:	:	:

Right-Hand Units

30"	66"	ZEWPR3066W	\$1074	\$1386	\$1439
30"	72"	ZEWPR3072W	\$1159	\$1497	\$1554
36"	66"	ZEWPR3666W	\$1186	\$1534	\$1591
36"	72"	ZEWPR3672W	\$1230	\$1590	\$1651
:	:	:	:	:	:

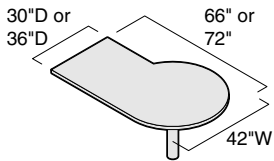
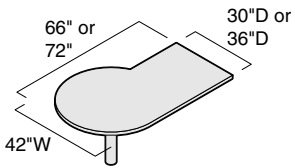

Montage

Wood Veneer Sock Top Worksurfaces

SIN 711.1

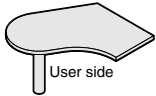

Left-Hand Unit

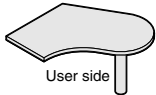

Right-Hand Unit

Tip: You can specify only one type of cable-management option on a worksurface.

Tip: If a plastic color is not specified for a grommet with color choices, 6000 Black plastic will be provided.

Tip: Grommets must be used for cable drops.

Tip: When mounting work-surfaces off module, you must use a combination of on-module and off-module supports.



Edge Profile Location

Tip: Your specification is not complete until you add a suffix to define the work-surface's edge profile.

Tip: On sock top work-surfaces, the radius (R) profile is not available because the edge is curved.

Standard Includes	Required to Specify
-------------------	---------------------

- Worksurface: wood veneer
- Height-adjustable support column: all paint price groups
- Edge profile: wood, except square profile which is wood veneer

- 1 Style number with appropriate edge-profile suffix
▶ See edge-profile suffixes at bottom of page.
- 2 Wood veneer color number for worksurface
- 3 Options, if selected (see below)
▶ See *Surface Materials*, page C252.

Options	Price	Required to Specify
---------	-------	---------------------

Surface Materials

- Full-fill finish +\$ 41
- Customiz stain on wood +\$ 41

Specify with *full-fill finish* and select wood color number.
Specify with *Customiz stain*.
▶ See *Surface Materials Reference Manual*.

Support column

- Paint No cost
- Polished Chrome +\$ 99
- Antique Bronze +\$131

Select paint color number for support column.
Specify with *9201 Polished Chrome support column*.
Specify with *9230 Antique Bronze support column*.

Cable Management

Three-piece grommet

- Centered on depth: plastic +\$ 25

Specify with *E91S01* and select plastic color number.

4" square grommet

- Centered on depth: black plastic only +\$ 25

Specify with *WWTPC*.

Supports

Frame-supported application

- Adjustable column
- Cantilevers
- Shared cantilevers
- Side-support brackets
- Off-module worksurface brackets
- Off-module tie plates

- ▶ Page C139
- ▶ Page C186
- ▶ Page C186
- ▶ Page C187
- ▶ Page C188
- ▶ Page C188

Edge Profiles

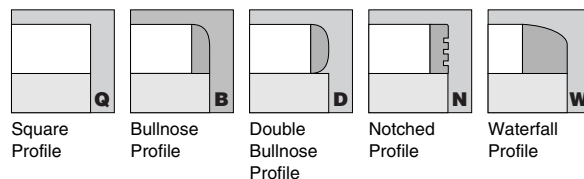

Specification Information

Length	Style Number	Base Price		
		Profile Q	Profile B, D, and N	Profile W

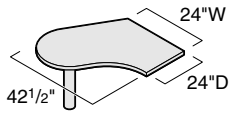

Left-Hand Unit

42 1/2"	ZEWSL24W	\$1343	\$1473	\$1761
:	:	:	:	:

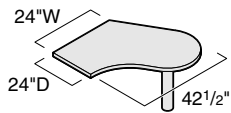

Right-Hand Unit

42 1/2"	ZEWSR24W	\$1343	\$1473	\$1761
:	:	:	:	:

Wood Veneer Scoop Top Worksurfaces

SIN 711.1

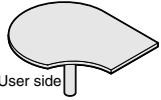

Left-Hand Unit

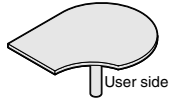

Right-Hand Unit

Tip: You can specify only one type of cable-management option on a worksurface.

Tip: If a plastic color is not specified for a grommet with color choices, 6000 Black plastic will be provided.

Tip: Grommets must be used for cable drops.

Tip: When mounting work-surfaces off module, you must use a combination of on-module and off-module supports.

Standard Includes	Required to Specify
-------------------	---------------------

- Worksurface: wood veneer
- Height-adjustable support column: all paint price groups
- Edge profile: wood, except square profile which is wood veneer

- 1 Style number with appropriate edge-profile suffix
▶ See edge-profile suffixes at bottom of page.
- 2 Wood veneer color number for worksurface
- 3 Options, if selected (see below)
▶ See *Surface Materials*, page C252.

Surface Materials	Options	Price	Required to Specify
-------------------	---------	-------	---------------------

- | | | | |
|-------------------|--------------------------|--------|---|
| Surface Materials | • Full-fill finish | +\$ 41 | Specify with <i>full-fill finish</i> and select wood color number. |
| | • Customiz stain on wood | +\$ 41 | Specify with <i>Customiz stain</i> .
▶ See <i>Surface Materials Reference Manual</i> . |

Support column	Options	Price	Required to Specify
----------------	---------	-------	---------------------

- | | | | |
|----------------|-------------------|---------|---|
| Support column | • Paint | No cost | Select paint color number for support column. |
| | • Polished Chrome | +\$ 99 | Specify with <i>9201 Polished Chrome support column</i> . |
| | • Antique Bronze | +\$131 | Specify with <i>9230 Antique Bronze support column</i> . |

Cable Management	Three-piece grommet	Price	Required to Specify
------------------	---------------------	-------	---------------------

- | | | | |
|------------------|------------------------------|--------|---|
| Cable Management | • Centered on depth: plastic | +\$ 25 | Specify with <i>E91SC1</i> and select plastic color number. |
|------------------|------------------------------|--------|---|

Cable Management	4" square grommet	Price	Required to Specify
------------------	-------------------	-------	---------------------

- | | | | |
|------------------|---|--------|-----------------------------|
| Cable Management | • Centered on depth: black plastic only | +\$ 25 | Specify with <i>WWTPC</i> . |
|------------------|---|--------|-----------------------------|

Supports	Frame-supported application	Price	Required to Specify
----------	-----------------------------	-------	---------------------

- | | | | |
|----------|-----------------------------------|--|-------------|
| Supports | • Cantilevers | | ▶ Page C186 |
| | • Shared cantilevers | | ▶ Page C186 |
| | • Side-support brackets | | ▶ Page C187 |
| | • Off-module worksurface brackets | | ▶ Page C188 |
| | • Off-module tie plates | | ▶ Page C188 |

Supports	Worksurface-supported application	Price	Required to Specify
----------	-----------------------------------	-------	---------------------

- | | | | |
|----------|-----------------------|--|-------------|
| Supports | • Adjustable column | | ▶ Page C139 |
| | • Flush-mount bracket | | ▶ Page C187 |

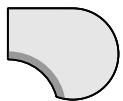

Edge Profile Location

Tip: Your specification is not complete until you add a suffix to define the work-surface's edge profile.

Tip: On scoop top work-surfaces, the radius (R) profile is not available because the edge is curved.

Edge Profiles

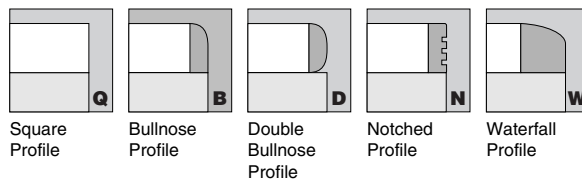

Square Profile (Q), Bullnose Profile (B), Double Bullnose Profile (D), Notched Profile (N), Waterfall Profile (W)

Specification Information

Length	Style Number	Base Price		
		Profile Q	Profile B, D, and N	Profile W

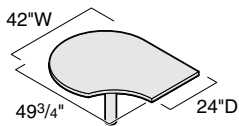

Left-Hand Unit

49 ³ / ₄ "	ZEWSCL24W __	\$1075	\$1180	\$1410
:	:	:	:	:

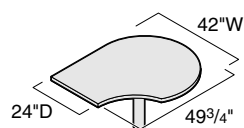

Right-Hand Unit

49 ³ / ₄ "	ZEWSR24W __	\$1075	\$1180	\$1410
:	:	:	:	:



Wood Veneer Curved-Front Transaction Worksurfaces

SIN 711.1

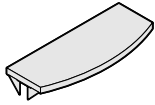

Tip: In applications using frames with wood top caps, specify quote CA008682 through Specials for required brackets.

Standard Includes

- Worksurface: wood veneer
- Attachment hardware: black paint only
- Edge profile: wood, except square profile which is wood veneer

Required to Specify

- 1 Style number with appropriate edge-profile suffix
- ▶ See edge-profile suffixes at bottom of page.
- 2 Wood veneer color number for worksurface
- 3 Options, if selected (see below)
- ▶ See *Surface Materials*, page C252.

Options

Surface Materials	Options	Price	Required to Specify
	• Full-fill finish	Prices below	Specify with <i>full-fill finish</i> and select wood color number.
	• Customiz stain on wood	Prices below	Specify with <i>Customiz stain</i> . ▶ See <i>Surface Materials Reference Manual</i> .

Specification Information

• Dimensions		• Style Number	• Base Price			• Option (Add \$ to Base Price)
D	W		Profile Q	Profile B, D, and N	Profile W	
15"	30"	ZEWTC30W__	\$311	\$341	\$376	+\$41
15"	36"	ZEWTC36W__	\$343	\$376	\$413	+\$41
15"	42"	ZEWTC42W__	\$392	\$430	\$470	+\$41
15"	48"	ZEWTC48W__	\$418	\$459	\$505	+\$41
15"	60"	ZEWTC60W__	\$574	\$629	\$691	+\$60



Edge Profile Location

Tip: Your specification is not complete until you add a suffix to define the worksurface's front and back edge profile.

Tip: On curved-front transaction worksurfaces, the radius (R) profile is not available because the edge is curved.

Edge Profiles

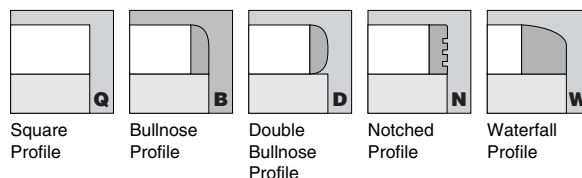

Worksurface Supports

SIN 711.1

Wood Veneer Frame-Supported End Panels



Tip: On-module end panels are for use at frame seam only.

Tip: Off-module end panels are for use in off-module positions only.

Standard Includes	Required to Specify
<ul style="list-style-type: none"> End panel: wood veneer 	1 Style number 2 Wood veneer color number for end panel 3 Options, if selected (see below) ▶ See <i>Surface Materials</i> , page C252.

Options	Price	Required to Specify
Surface Materials • End panel • Customiz stain on wood	Prices below	Specify with <i>Customiz stain</i> . ▶ See <i>Surface Materials</i> , page C252.

Specification Information						
Dimensions			End Panel Location	Style Number	Base Price	Option (Add \$ to Base Price)
D	W	H				Customiz Stain

For On-Module Applications

24"	1 1/4"	27"	Left	ZEPW24LH	\$276	+\$41
30"	1 1/4"	27"	Left	ZEPW30LH	\$301	+\$60
24"	1 1/4"	27"	Right	ZEPW24RH	\$276	+\$41
30"	1 1/4"	27"	Right	ZEPW30RH	\$301	+\$60

For Off-Module Applications

24"	1 1/4"	27"	Left	ZEPW24LHOM	\$165	+\$41
30"	1 1/4"	27"	Left	ZEPW30LHOM	\$176	+\$60
24"	1 1/4"	27"	Right	ZEPW24RHOM	\$165	+\$41
30"	1 1/4"	27"	Right	ZEPW30RHOM	\$176	+\$60

Montage

Worksurface Supports, continued

SIN 711.1

Wood Veneer T-Shape End Panels

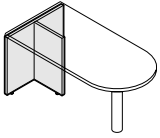

Tip: Worksurface must be connected to a bridge, return, or adjoining worksurface to form an L- or U-shaped configuration and to provide proper stability. Additional attachment hardware may need to be ordered.

Standard Includes	Required to Specify
<ul style="list-style-type: none"> T-shape end panel support: wood veneer 	1 Style number 2 Wood veneer color number 3 Options, if selected (see below) ▶ See <i>Surface Materials</i> , page C252.

Surface Materials	Options	End panel	Price	Required to Specify
		<ul style="list-style-type: none"> Customiz stain on wood 	Prices below	Specify with <i>Customiz stain</i> . ▶ See <i>Surface Materials</i> , page C252.

Specification Information				
Dimensions	Style Number	Base Price	Option	
D	W		(Add \$ to Base Price)	
			Customiz Stain	
30"	15"	ZETP3015W	\$573	+\$65
36"	15"	ZETP3615W	\$598	+\$84

Cantilevers

Tip: Shared cantilevers can only be used to support worksurfaces with their own column supports—bullet top, P-top, sock top, and scoop top worksurfaces.

Tip: Shared cantilevers must be used on both sides of a spanner worksurface.

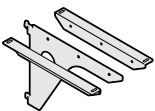
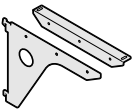

Standard Includes	Required to Specify
<ul style="list-style-type: none"> Cantilever and attachment brackets: black paint only 	Style number

Specification Information	
Style Number	Price

Cantilever (non-handed)

ZCB \$37

Shared Cantilever

ZCSB \$49

Side-Support Brackets



Tip: Brackets are used in on-module positions only.

Standard Includes		Required to Specify
<ul style="list-style-type: none"> • Pair of side-support brackets: black paint only 		Style number
Specification Information		
Style Number	Price	
ZBES	\$25	

Flush-Mount Bracket

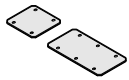

Standard Includes		Required to Specify
<ul style="list-style-type: none"> • Flush-mount bracket: black paint only 		Style number
Specification Information		
Style Number	Price	
ZE91903	\$15	

Corner Worksurface Bracket



Tip: Bracket is used in on-module positions only. Brackets must be specified to support back corner of Wood Selections corner and cornerstone worksurfaces.

Standard Includes		Required to Specify
<ul style="list-style-type: none"> • Corner worksurface bracket: black paint only 		Style number
Specification Information		
Style Number	Price	
ZWCB	\$25	

Worksurface Supports, continued

SIN 711.1

Off-Module Worksurface Brackets



Tip: Brackets are used in off-module situations only.

Tip: Off-module brackets must be used in conjunction with other on-module supports to provide forward worksurface tip support.

Standard Includes	Required to Specify
<ul style="list-style-type: none"> • Pair of worksurface brackets: all paint price groups 	1 Style number 2 Paint color number for brackets ▶ See <i>Surface Materials</i> , page C252.

Specification Information

•Style Number	•Price
ZBWOM	\$25

Off-Module Tie Plates



Tip: Tie plate is used in conjunction with an off-module worksurface bracket.

Standard Includes	Required to Specify
<ul style="list-style-type: none"> • Tie plate (carton of five): black paint only 	Style number

Specification Information

•Style Number	•Price
ZBTP	\$20

End-of-Run Cantilevers

Tip: End-of-run cantilevers are used in on-module vertical upright situations only.

Tip: End-of-run cantilevers are used at the end of a corner worksurface.

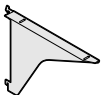
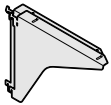

Standard Includes	Required to Specify
<ul style="list-style-type: none"> • End-of-run cantilever and attachment brackets: all paint price groups 	1 Style number 2 Paint color number for cantilever ▶ See <i>Surface Materials</i> , page C252.

Specification Information

•Style Number	•Price
---------------	--------

Left-Hand

ZCEL	\$49
------	------

Right-Hand

ZCER	\$49
------	------

Wood Veneer Tether Table

SIN 711.1

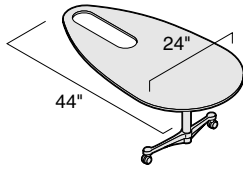

Tip: Remember to push the table fully under the work-surface before swinging it underneath to avoid damage by the cantilevers.

Standard Includes	Required to Specify
-------------------	---------------------

- Worksurface: wood veneer
- Tethering bracket to link to adjacent support column: black paint only
- Leg with casters: black paint only

- 1 Style number
 - 2 Wood veneer color number for worksurface
 - 3 Options, if selected (see below)
- ▶ See *Surface Materials*, page C252.

Surface Materials	Options	Price	Required to Specify
-------------------	---------	-------	---------------------

Surface Materials

- Full-fill finish on worksurface +\$41
- Customiz stain on wood +\$41

- Specify *with full-fill finish* and select wood veneer color number for worksurface.
Specify *with Customiz stain*.
▶ See *Surface Materials Reference Manual*.

Specification Information				
• Dimensions			• Style	• Base
D	W	H	Number	Price

44"	24"	26"	ZEWTTW	\$764
-----	-----	-----	---------------	-------

Montage

Wood Veneer Freestanding Desk Shells

SIN 711.1

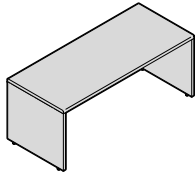

Standard Includes	Required to Specify
<ul style="list-style-type: none"> • Worksurface with square edge profile (Q), end panels, and flush back panel: wood veneer • Quick-lock assembly hardware 	1 Style number 2 Color number for wood veneer 3 Options, if selected (see below) ▶ See <i>Surface Materials</i> , page C252.

Options	Price	Required to Specify
Surface Materials Shell <ul style="list-style-type: none"> • Full-fill finish on worksurface • Customiz stain on wood 	Prices at right Prices at right	Specify with <i>full-fill finish</i> and select wood veneer color number for worksurface. Specify with <i>Customiz stain</i> . ▶ See <i>Surface Materials Reference Manual</i> .
Front Edge Profile <ul style="list-style-type: none"> • Radius profile (R) • Double Bullnose profile (D) • Notched profile (N) • Waterfall profile (W) 	No cost Prices at right Prices at right Prices at right	Specify with <i>Radius profile</i> . Specify with <i>Double Bullnose profile</i> . Specify with <i>Notched profile</i> . Specify with <i>Waterfall profile</i> .
Lock and Keying <ul style="list-style-type: none"> • Available only on shells with – Square profile (Q) – Radius profile (R) – Double Bullnose profile (D) 	Lock, keyed random: 9250 Ember Chrome +\$116	Add suffix L to style number.
	Alternative lock color on worksurface with locks <ul style="list-style-type: none"> • Polished Chrome • Antique Bronze 	No cost No cost Specify with <i>9201 Polished Chrome lock</i> . Specify with <i>9230 Antique Bronze lock</i> .
	Keying <ul style="list-style-type: none"> • Factory- and field-installed keying 	▶ Page C262

Tip: Pedestals may block access to grommets.

Tip: You can specify only one type of cable-management option on a worksurface.

Cable Management <ul style="list-style-type: none"> • Available on worksurfaces: plastic <i>Exception: Rear grommets are not available on worksurfaces with recessed back panel.</i> <i>Tip: 6000 Black plastic will be provided if no plastic color is specified.</i> 	Three-piece grommets +\$ 25 each	Rear left: <i>E91RL4</i> and color number. Rear right: <i>E91RR6</i> and color number. Rear center: <i>E91RC1</i> and color number. Center left: <i>E91CL9</i> and color number. Center right: <i>E91CR1</i> and color number. Center center: <i>E91CC6</i> and color number. Front left: <i>E91FL8</i> and color number. Front right: <i>E91FR0</i> and color number. Front center: <i>E91FC5</i> and color number.
<ul style="list-style-type: none"> • Available centered along back edge of worksurface with flush back panel: black plastic only • Available left- and right-hand side of worksurface with flush back panel: black plastic only 	4"-square grommets +\$ 25 +\$ 50	Specify with <i>WWTPC</i> . Specify with <i>WWTPLR</i> .

▶ Cable Management and more Options continued on next page



Edge Profile Location

Tip: On a wood veneer free-standing desk shell, the bullnose (B) profile is not available.

Edge Profiles

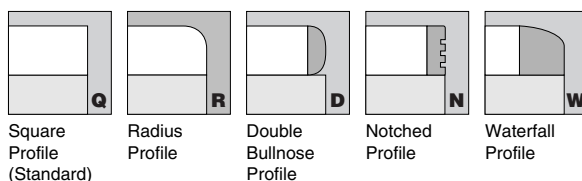

► Options continued from previous page

Options	Price	Required to Specify
Cable Management, continued Channel grommet <ul style="list-style-type: none"> Available on back of worksurface with flush back panel: black plastic only 	+\$250	Specify with <i>WWTPF</i> .
Recessed Back Panel <ul style="list-style-type: none"> Back panel recessed on 30"D and 36"D desk shells 	No cost	Specify with <i>recessed back panel</i> .
Cable-Management Back Panel <ul style="list-style-type: none"> With shortened back panel for cable management 	+\$ 12	Specify with <i>cable-management back panel</i> .
Related Products <ul style="list-style-type: none"> Worksurface wiring and cabling Pedestals 		<ul style="list-style-type: none"> ► Page C143 ► Page C206

Tip: On shells with recessed back panels, you can't specify three-piece rear grommets, 4"-square grommets, or channel grommet.

Specification Information

Width	Style Number	Base Price	Options (Add \$ to Base Price)			
			Profile : Profile : Profile	Full-Fill	Customiz	
			Q and R	D and N	W	Finish : Stain
30"D						
60"	ZEFS3060W	\$1863	\$2012	\$2039	+\$60	+\$287
66"	ZEFS3066W	\$1885	\$2056	\$2088	+\$60	+\$287
72"	ZEFS3072W	\$1992	\$2180	\$2212	+\$60	+\$287
:	:	:	:	:	:	:
36"D						
72"	ZEFS3672W	\$2115	\$2345	\$2385	+\$84	+\$311
:	:	:	:	:	:	:

Montage

Wood Veneer Return Shells

SIN 711.1

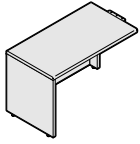

Tip: Left-hand units are standard. Right-hand units are specified as an option.
 ▶ See End Panels
 Transposed option on next page.

Standard Includes		Required to Specify		
<ul style="list-style-type: none"> • Worksurface with square edge profile (Q), left-hand end panel, right-hand filler panel, and flush back panel: wood veneer • Flush-mount bracket: black paint only • Quick-lock assembly hardware 		1 Style number 2 Color number for wood veneer 3 Options, if selected (see below) ▶ See <i>Surface Materials</i> , page C252.		
Surface Materials	Options	Price	Required to Specify	
Shell <ul style="list-style-type: none"> • Full-fill finish on worksurface • Customiz stain on wood 		Prices at right	Specify with <i>full-fill finish</i> and select wood veneer color number for worksurface.	
		Prices at right	Specify with <i>Customiz stain</i> . ▶ See <i>Surface Materials Reference Manual</i> .	
Front Edge Profile <ul style="list-style-type: none"> • Radius profile (R) • Double Bullnose profile (D) • Notched profile (N) • Waterfall profile (W) 		No cost	Specify with <i>Radius profile</i> .	
		Prices at right	Specify with <i>Double Bullnose profile</i> .	
		Prices at right	Specify with <i>Notched profile</i> .	
		Prices at right	Specify with <i>Waterfall profile</i> .	
Lock and Keying Lock, keyed random: 9250 Ember Chrome <ul style="list-style-type: none"> • Available only on shells with – Square profile (Q) – Radius profile (R) – Double Bullnose profile (D) 		+\$116	Add suffix L to style number.	
	Alternative lock color on worksurface with locks <ul style="list-style-type: none"> • Polished Chrome • Antique Bronze 		No cost No cost	Specify with <i>9201 Polished Chrome lock</i> . Specify with <i>9230 Antique Bronze lock</i> .
	Keying <ul style="list-style-type: none"> • Factory- and field-installed keying 			▶ Page C262
Cable Management Three-piece grommets <ul style="list-style-type: none"> • Available on worksurfaces: plastic <i>Exception: Rear grommets are not available on worksurfaces with recessed back panel.</i> Tip: 6000 Black plastic will be provided if no plastic color is specified.		+\$ 25 each	Rear left: <i>E91RL4</i> and color number. Rear right: <i>E91RR6</i> and color number. Rear center: <i>E91RC1</i> and color number. Center left: <i>E91CL9</i> and color number. Center right: <i>E91CR1</i> and color number. Center center: <i>E91CC6</i> and color number. Front left: <i>E91FL8</i> and color number. Front right: <i>E91FR0</i> and color number. Front center: <i>E91FC5</i> and color number.	
	4"-square grommets <ul style="list-style-type: none"> • Available centered along back edge of worksurface with flush back panel: black plastic only • Available left- and right-hand side of worksurface with flush back panel: black plastic only 		+\$ 25 +\$ 50	Specify with <i>WWTPC</i> . Specify with <i>WWTPLR</i> .

Tip: Pedestals may block access to grommets.

Tip: You can specify only one type of cable-management option on a worksurface.

▶ Cable Management and more Options continued on next page



Edge Profile Location

Tip: On a wood veneer return shell, the bullnose (B) profile is not available.

Edge Profiles

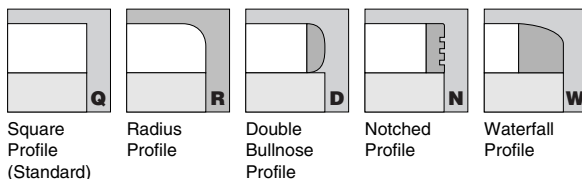

SIN 711.1

► Options continued from previous page

Options	Price	Required to Specify
Cable Management, continued <ul style="list-style-type: none"> Channel grommet • Available on back of worksurface with flush back panel: black plastic only 	+\$250	Specify with WWTPF.
End Panels Transposed <ul style="list-style-type: none"> • Right-hand end panel and left-hand filler panel 	No cost	Specify with end panel right.
Cable-Management Back Panel <ul style="list-style-type: none"> • With shortened back panel for cable management 	+\$ 12	Specify with cable-management back panel.
Related Products <ul style="list-style-type: none"> • Worksurface wiring and cabling • Pedestals 		<ul style="list-style-type: none"> ► Page C143 ► Page C206

Specification Information

Width	Style Number	Base Price	Options (Add \$ to Base Price)				
			Profile Q and R	Profile D and N	Profile W	Full-Fill Finish	Customiz Stain

24"D

48"	ZERS2448W	\$1298	\$1385	\$1392	+\$41	+\$143
60"	ZERS2460W	\$1524	\$1645	\$1665	+\$60	+\$209

30"D

48"	ZERS3048W	\$1432	\$1541	\$1560	+\$41	+\$161
60"	ZERS3060W	\$1642	\$1791	\$1818	+\$60	+\$227



Wood Veneer Bridge Shells

SIN 711.1

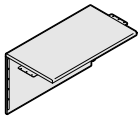

Tip: When attaching a bridge shell to a freestanding corner or cornerstone worksurface, an additional bracket kit is required. Order Y55088 bracket kit for installation.

Tip: You can specify only one type of cable-management option on a worksurface.

Standard Includes		Required to Specify	
<ul style="list-style-type: none"> • Worksurface with square edge profile (Q) and flush back panel: wood veneer • Two flush-mount brackets: black paint only • Quick-lock assembly hardware 		1 Style number 2 Color number for wood veneer 3 Options, if selected (see below) ▶ See <i>Surface Materials</i> , page C252.	
Surface Materials	Options	Price	Required to Specify
	Shell		
	<ul style="list-style-type: none"> • Full-fill finish on worksurface • Customiz stain on wood 	Prices at right Prices at right	Specify with <i>full-fill finish</i> and select wood veneer color number for worksurface. Specify with <i>Customiz stain</i> . ▶ See <i>Surface Materials Reference Manual</i> .
Front Edge Profile	<ul style="list-style-type: none"> • Radius profile (R) • Double Bullnose profile (D) • Notched profile (N) • Waterfall profile (W) 	No cost Prices at right Prices at right Prices at right	Specify with <i>Radius profile</i> . Specify with <i>Double Bullnose profile</i> . Specify with <i>Notched profile</i> . Specify with <i>Waterfall profile</i> .
Lock and Keying	Lock, keyed random: 9250 Ember Chrome <ul style="list-style-type: none"> • Available only on shells with – Square profile (Q) – Radius profile (R) – Double Bullnose profile (D) 	+\$116	Add suffix L to style number.
	Alternative lock color on worksurface with locks <ul style="list-style-type: none"> • Polished Chrome • Antique Bronze 	No cost No cost	Specify with <i>9201 Polished Chrome lock</i> . Specify with <i>9230 Antique Bronze lock</i> .
	Keying <ul style="list-style-type: none"> • Factory- and field-installed keying 		▶ Page C262
Cable Management	Three-piece grommets <ul style="list-style-type: none"> • Available on worksurfaces: plastic <i>Exception: Rear grommets are not available on worksurfaces with recessed back panel.</i> Tip: 6000 Black plastic will be provided if no plastic color is specified.	+\$ 25 each	Rear left: <i>E91RL4</i> and color number. Rear right: <i>E91RR6</i> and color number. Rear center: <i>E91RC1</i> and color number. Center left: <i>E91CL9</i> and color number. Center right: <i>E91CR1</i> and color number. Center center: <i>E91CC6</i> and color number. Front left: <i>E91FL8</i> and color number. Front right: <i>E91FR0</i> and color number. Front center: <i>E91FC5</i> and color number.
	4"-square grommets <ul style="list-style-type: none"> • Available centered along back edge of worksurface with flush back panel: black plastic only • Available left- and right-hand side of worksurface with flush back panel: black plastic only 	+\$ 25 +\$ 50	Specify with <i>WWTPC</i> . Specify with <i>WWTPLR</i> .
	Channel grommet <ul style="list-style-type: none"> • Available on back of worksurface with flush back panel: black plastic only 	+\$250	Specify with <i>WWTPF</i> .

▶ Options continued on next page



Edge Profile Location

Tip: On a wood veneer bridge shell, the bullnose (B) profile is not available.

Edge Profiles

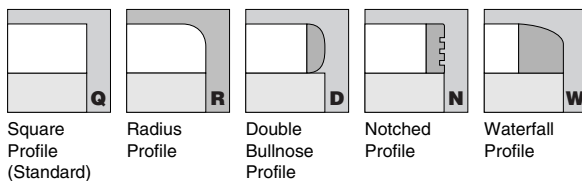

► Options continued from previous page

Options	Price	Required to Specify
Cable-Management Back Panel	• With shortened back panel for cable management +\$ 12	Specify with cable-management back panel.
Related Products	• Worksurface wiring and cabling	► Page C143

Specification Information

Width	Style Number	Base Price	Options (Add \$ to Base Price)				
			Profile Q and R	Profile D and N	Profile W	Full-Fill Finish	Customiz Stain

24"D

42"	ZEBS2442W	\$ 936	\$1013	\$1027	+\$41	+\$101
48"	ZEBS2448W	\$1036	\$1123	\$1130	+\$60	+\$120
:	:	:	:	:	:	:

30"D

42"	ZEBS3042W	\$ 857	\$ 954	\$ 971	+\$60	+\$120
48"	ZEBS3048W	\$1144	\$1253	\$1272	+\$60	+\$120
:	:	:	:	:	:	:



Wood Veneer Credenza Shells

SIN 711.1

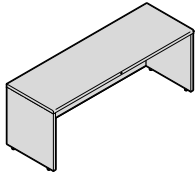

Standard Includes	Required to Specify
<ul style="list-style-type: none"> • Worksurface with square edge profile (Q), two end panels, and flush back panel: wood veneer • Quick-lock assembly hardware 	<ul style="list-style-type: none"> 1 Style number 2 Color number for wood veneer 3 Options, if selected (see below) ▶ See <i>Surface Materials</i>, page C252.

Options	Price	Required to Specify
Surface Materials Shell <ul style="list-style-type: none"> • Full-fill finish on worksurface • Customiz stain on wood 	<ul style="list-style-type: none"> Prices at right Prices at right 	<ul style="list-style-type: none"> Specify with <i>full-fill finish</i> and select wood veneer color number for worksurface. Specify with <i>Customiz stain</i>. ▶ See <i>Surface Materials Reference Manual</i>.
Front Edge Profile <ul style="list-style-type: none"> • Radius profile (R) • Double Bullnose profile (D) • Notched profile (N) • Waterfall profile (W) 	<ul style="list-style-type: none"> No cost Prices at right Prices at right Prices at right 	<ul style="list-style-type: none"> Specify with <i>Radius profile</i>. Specify with <i>Double Bullnose profile</i>. Specify with <i>Notched profile</i>. Specify with <i>Waterfall profile</i>.
Lock and Keying <ul style="list-style-type: none"> • Available only on shells with – Square profile (Q) – Radius profile (R) – Double Bullnose profile (D) 	Lock, keyed random: 9250 Ember Chrome +\$116	Add suffix L to style number.
	Alternative lock color on worksurface with locks <ul style="list-style-type: none"> • Polished Chrome • Antique Bronze 	<ul style="list-style-type: none"> No cost No cost <ul style="list-style-type: none"> Specify with <i>9201 Polished Chrome lock</i>. Specify with <i>9230 Antique Bronze lock</i>.
	Keying <ul style="list-style-type: none"> • Factory- and field-installed keying 	▶ Page C262
Cable Management	Three-piece grommets <ul style="list-style-type: none"> • Available on worksurfaces: plastic <i>Exception: Rear grommets are not available on worksurfaces with recessed back panel.</i> <i>Tip: 6000 Black plastic will be provided if no plastic color is specified.</i> 	+\$ 25 each Rear left: <i>E91RL4</i> and color number. Rear right: <i>E91RR6</i> and color number. Rear center: <i>E91RC1</i> and color number. Center left: <i>E91CL9</i> and color number. Center right: <i>E91CR1</i> and color number. Center center: <i>E91CC6</i> and color number. Front left: <i>E91FL8</i> and color number. Front right: <i>E91FR0</i> and color number. Front center: <i>E91FC5</i> and color number.
	4"-square grommets <ul style="list-style-type: none"> • Available centered along back edge of worksurface with flush back panel: black plastic only • Available left- and right-hand side of worksurface with flush back panel: black plastic only 	+\$ 25 +\$ 50 Specify with <i>WWTPC</i> . Specify with <i>WWTPLR</i> .
	Channel grommet <ul style="list-style-type: none"> • Available on back of worksurface with flush back panel: black plastic only 	+\$250 Specify with <i>WWTPF</i> .

Tip: Pedestals, towers, and spanner tackboards or wood veneer panel may block access to grommets.

Tip: You can specify only one type of cable-management option on a worksurface.



Edge Profile Location

Tip: On a wood veneer credenza shell, the bullnose (B) profile is not available.

▶ Cable Management and more Options continued on next page

Edge Profiles

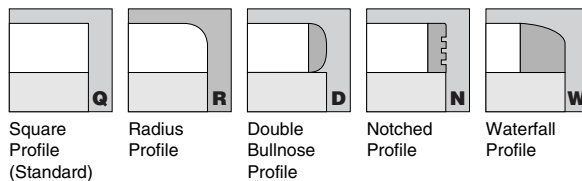

Square Profile (Standard)

Radius Profile

Double Bullnose Profile

Notched Profile

Waterfall Profile

► Options continued from previous page

Options	Price	Required to Specify
Cable-Management Back Panel	• With shortened back panel for cable management +\$12	Specify with cable-management back panel.
Related Products	• Worksurface wiring and cabling • Pedestals	► Page C143 ► Page C206

Specification Information

Width	Style Number	Base Price	Options (Add \$ to Base Price)				
			Profile Q and R	Profile D and N	Profile W	Full-Fill Finish	Customiz Stain

24"D

72"	ZECS2472W	\$1786	\$1932	\$1956	+\$60	+\$251
90"	ZECS2490W	\$2221	\$2413	\$2459	+\$60	+\$279

30"D

90"	ZECS3090W	\$2382	\$2621	\$2661	+\$84	+\$339
-----	------------------	--------	--------	--------	-------	--------

Specification Information

Dimensions			Style Number	Base Price	Option (Add \$ to Base Price)
D	W	H			
:	:	:	:	:	Customiz
:	:	:	:	:	Stain

For Use with 27"H Back Panels

Left-Hand End Panel for Use with Flush Back Panel

15"	1 1/4"	27"	ZEP1527FLW	\$224	+\$24
24"	1 1/4"	27"	ZEP2427FLW	\$276	+\$42
30"	1 1/4"	27"	ZEP3027FLW	\$302	+\$60
36"	1 1/4"	27"	ZEP3627FLW	\$326	+\$60

Right-Hand End Panel for Use with Flush Back Panel

15"	1 1/4"	27"	ZEP1527FRW	\$224	+\$24
24"	1 1/4"	27"	ZEP2427FRW	\$276	+\$42
30"	1 1/4"	27"	ZEP3027FRW	\$302	+\$60
36"	1 1/4"	27"	ZEP3627FRW	\$326	+\$60

Left-Hand End Panel for Use with Recessed Back Panel

15"	1 1/4"	27"	ZEP1527RLW	\$224	+\$24
30"	1 1/4"	27"	ZEP3027RLW	\$302	+\$60
36"	1 1/4"	27"	ZEP3627RLW	\$326	+\$60

Right-Hand End Panel for Use with Recessed Back Panel

15"	1 1/4"	27"	ZEP1527RRW	\$224	+\$24
30"	1 1/4"	27"	ZEP3027RRW	\$302	+\$60
36"	1 1/4"	27"	ZEP3627RRW	\$326	+\$60

SIN 711.1

Wood Veneer Filler Panels



Tip: These filler panels are used in return shell buildups only. They must be used with a back panel; either flush or recessed.

Tip: Left and right is specified in relation to a user sitting at the desk.

Standard Includes	Required to Specify
<ul style="list-style-type: none"> • Filler panel: wood veneer 	<ul style="list-style-type: none"> 1 Style number 2 Wood veneer color number 3 Options, if selected (see below) ▶ See <i>Surface Materials</i>, page C252.

Options	Price	Required to Specify
Surface Materials <ul style="list-style-type: none"> • Customiz stain on wood 	No cost	<ul style="list-style-type: none"> Specify with <i>Customiz stain</i>. ▶ See <i>Surface Materials</i>, page C252.

Specification Information

• Back Panel Position	• Filler Panel Location	• Dimensions			• Style Number	• Price
		D	W	H		

For Use with 10"H Back Panels

Flush back panel	Left-hand side	5"	1¼"	27"	ZEFP510FLW	\$66
Flush back panel	Right-hand side	5"	1¼"	27"	ZEFP510FRW	\$66

For Use with 27"H Back Panels

Flush back panel	Left-hand side	5"	1¼"	27"	ZEFP527FLW	\$66
Flush back panel	Right-hand side	5"	1¼"	27"	ZEFP527FRW	\$66
Recessed back panel	Left-hand side	5"	1¼"	27"	ZEFP527RLW	\$66
Recessed back panel	Right-hand side	5"	1¼"	27"	ZEFP527RRW	\$66

Wood Veneer Center-Support Panel



Standard Includes	Required to Specify
<ul style="list-style-type: none"> Center support: wood veneer Attachment hardware 	<ol style="list-style-type: none"> Style number Wood veneer color number for center-support panel Options, if selected (see below) <p>▶ See <i>Surface Materials</i>, page C252.</p>

Options	Price	Required to Specify
Surface Materials <ul style="list-style-type: none"> Customiz stain on wood 	Prices below	Specify <i>with Customiz stain</i> . ▶ See <i>Surface Materials</i> , page C252.

Specification Information

Dimensions			Style	Base	Option
D	W	H	Number	Price	(Add \$ to Base Price)
15"	1 1/4"	27"	ZECP15W	\$224	+\$24
..
..
..

Montage

SIN 711.1

Wood Veneer Back Panels

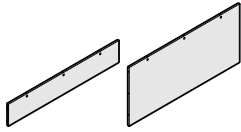

Tip: These back panels are used in shell buildups.

Tip: The 10"H back panel cannot be recessed.

Standard Includes		Required to Specify	
<ul style="list-style-type: none"> Back panel: wood veneer 		1 Style number 2 Wood veneer color number 3 Options, if selected (see below) ▶ See <i>Surface Materials</i> , page C252.	
Options		Price	Required to Specify
Surface Materials	<ul style="list-style-type: none"> Customiz stain on wood 	Prices below	Specify with <i>Customiz stain</i> . ▶ See <i>Surface Materials</i> , page C252.
Cable-Management Back Panel	<ul style="list-style-type: none"> With shortened back panel for cable management 	+\$12	Add suffix CM to the style number.

Specification Information				
Width	Fits Worksurface Width	Style Number	Base Price	Option (Add \$ to Base Price)
:	:	:	:	Customiz Stain

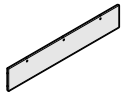

10"H Back Panels

For Use with Desk, Return, and Credenza Shell Buildups

39½"	42"	ZEBP4210W	\$455	+\$ 24
45½"	48"	ZEBP4810W	\$479	+\$ 24
57½"	60"	ZEBP6010W	\$589	+\$ 41
63½"	66"	ZEBP6610W	\$609	+\$ 41
69½"	72"	ZEBP7210W	\$631	+\$ 41
87½"	90"	ZEBP9010W	\$883	+\$ 60

For Use with Bridge Shell Buildups*

42"	42"	ZEBPB4210W	\$479	+\$ 41
48"	48"	ZEBPB4810W	\$544	+\$ 41

27"H Back Panels

For Use with Desk, Return, and Credenza Shell Buildups

39½"	42"	ZEBP4227W	\$455	+\$ 60
45½"	48"	ZEBP4827W	\$479	+\$ 60
57½"	60"	ZEBP6027W	\$589	+\$107
63½"	66"	ZEBP6627W	\$609	+\$107
69½"	72"	ZEBP7227W	\$631	+\$107
87½"	90"	ZEBP9027W	\$883	+\$135

For Use with Bridge Shell Buildups*

42"	42"	ZEBPB4227W	\$479	+\$ 60
48"	48"	ZEBPB4827W	\$544	+\$ 60

*Back panels for use with bridge shell buildups are the same width as the worksurface and ship with Z-bracket attachment hardware to connect to the end panels on adjacent desk shells, credenza shells, or T-shape end panels.

Wood Veneer Pedestals

SIN 711.1



Standard Includes	Required to Specify
<ul style="list-style-type: none"> • Pedestal: wood veneer • Drawer pulls • Locking mechanism that ties into worksurface lock • One hanging file folder frame per file drawer: black plastic only • One partition per box drawer: black plastic only • One pencil tray per two box drawers: black plastic only 	<ol style="list-style-type: none"> 1 Style number 2 Wood veneer color number for pedestal 3 Drawer pull shape and finish number 4 Options, if selected (see below) <p>▶ See <i>Surface Materials</i>, page C252.</p>

Options	Price	Required to Specify
Surface Materials <ul style="list-style-type: none"> • Customiz stain on wood 	Prices at right	Specify with <i>Customiz stain</i> . ▶ See <i>Surface Materials Reference Manual</i> .
Lock and Keying <ul style="list-style-type: none"> • Lock, keyed random: 9250 Ember Chrome 	+\$50	Add suffix L to style number.
Lock <ul style="list-style-type: none"> • Antique Bronze • Polished Chrome 	No cost No cost	Specify with <i>9230 Antique Bronze lock</i> . Specify with <i>9201 Polished Chrome lock</i> .
Keying <ul style="list-style-type: none"> • Factory- and field-installed keying 		▶ Page C262

Drawer Pull Shape <ul style="list-style-type: none"> • Lip drawer pull • Flush drawer pull • Crescent drawer pull • Contemporary drawer pull • Traditional drawer pull • Bow drawer pull • Rail drawer pull 	No cost No cost +\$22 each +\$22 each +\$22 each +\$22 each +\$22 each	Specify with <i>lip drawer pull E030</i> and select 0835 Black, 9201 Polished Chrome, or 9230 Antique Bronze. Specify with <i>flush drawer pull E020</i> and select 0835 Black, 9201 Polished Chrome, or 9230 Antique Bronze. Specify with <i>crescent drawer pull E040</i> and select 0835 Black, 9201 Polished Chrome, 9230 Antique Bronze, or 9213 Polished Nickel. Specify with <i>contemporary drawer pull E070</i> and select 0835 Black, 9201 Polished Chrome, or 9212 Silver. Specify with <i>traditional drawer pull E080</i> and select 9230 Antique Bronze. Specify with <i>bow drawer pull E060</i> and select 0835 Black or 9211 Nickel. Specify with <i>rail drawer pull E050</i> and select 0835 Black or 9211 Nickel.
---	--	---

Related Products <ul style="list-style-type: none"> • Frame-supported end panels 		▶ Page C185
--	--	-------------

Tip: When you add more than one suffix to style number, always add the **L** suffix first.

Tip: Pedestals can be used in on-module or off-module positions.

Tip: 24"D wood veneer pedestals cannot be used with 24"D shells, credenzas, or 24"D torus edge tops. Use the 23"D wood veneer pedestals.

Tip: Pull locations vary by cabinet and pull type.

Drawer Pull Shape

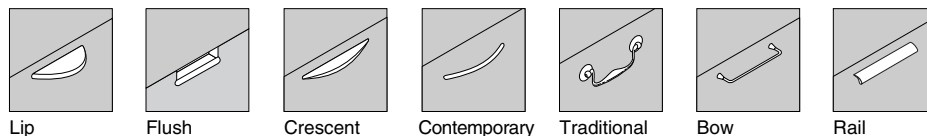

Specification Information

• Dimensions			• Style Number	• Base Price	• Option (Add \$ to Base Price)
D	W	H			
:	:	:	:	:	Customiz
:	:	:	:	:	Stain



Two File Drawers

19"	15"	27"	ZEPFF19W	\$ 796	+\$57
23"	15"	27"	ZEPFF23W	\$ 869	+\$57
24"	15"	27"	ZEPFF24W	\$ 869	+\$57
29"	15"	27"	ZEPFF29W	\$ 935	+\$57
:	:	:	:	:	:



Two Box Drawers and One File Drawer

19"	15"	27"	ZEPBBF19W	\$ 849	+\$57
23"	15"	27"	ZEPBBF23W	\$ 922	+\$57
24"	15"	27"	ZEPBBF24W	\$ 922	+\$57
29"	15"	27"	ZEPBBF29W	\$ 989	+\$57
:	:	:	:	:	:

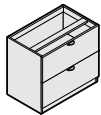

Two-Drawer Lateral File

19"	30"	27"	ZEPLF1930W	\$1184	+\$75
19"	36"	27"	ZEPLF1936W	\$1500	+\$75
:	:	:	:	:	:

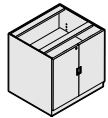

Two Doors with Adjustable Shelf

19"	27½"	27"	ZEPDDW	\$1077	+\$75
:	:	:	:	:	:

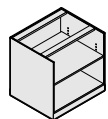

Open Pedestal with Adjustable Shelf

19"	27½"	27"	ZEPOPW	\$ 979	+\$75
:	:	:	:	:	:



Metal Pedestals with Wood Drawer Fronts and Off-Module Filler

SIN 711.1

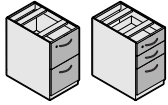

Tip: Pedestals are used in off-module positions.

Tip: Pedestals can be converted to on-module pedestals through Service Parts.

Standard Includes	Required to Specify
<ul style="list-style-type: none"> • Pedestal: paint price group 1 • Drawer fronts: wood veneer • Waterfall, Rod, or Contemporary pulls • Full drawer interiors: black only <ul style="list-style-type: none"> – Full-depth drawer body – Full extension drawer suspensions – One pencil tray per box/box/file, box drawer dividers, and adjustable file rails • Lock, keyed random: 9201 Polished Chrome • Four adjustable leveling glides • Off-module filler and interface brackets 	<ol style="list-style-type: none"> 1 Style number 2 Paint color number for pedestal 3 Wood veneer color number for drawer fronts 4 Color number for drawer pulls 5 Options, if selected (see below) <ul style="list-style-type: none"> ▶ See <i>Surface Materials</i>, page C252.

Options	Price	Required to Specify
Surface Materials <ul style="list-style-type: none"> • Paint price group 1 • Paint price group 2 • Paint price group 3 • Customiz stain on wood veneer 	<ul style="list-style-type: none"> No cost +\$38 +\$65 +\$12 	<ul style="list-style-type: none"> Specify paint color number. Specify paint color number. Specify paint color number. Specify <i>with Customiz stain</i>.
Pulls <p>Waterfall and rod pulls</p> <ul style="list-style-type: none"> • Paint • Plated metal <p>Contemporary pulls</p> <ul style="list-style-type: none"> • Plated metal 	<ul style="list-style-type: none"> No cost +\$13 per drawer No cost 	<ul style="list-style-type: none"> Specify paint color number. Specify plated metal color number. Specify plated metal color number: <ul style="list-style-type: none"> 0835 Black 9201 Polished Chrome 9211 Nickel 9212 Silver
Filler <ul style="list-style-type: none"> • No filler 	<ul style="list-style-type: none"> –\$25 	<ul style="list-style-type: none"> Specify <i>with no filler</i>.
Lock and Keying <p>Lock</p> <ul style="list-style-type: none"> • Ember Chrome • No lock <p>Individual locking drawers</p> <ul style="list-style-type: none"> • File/file pedestals only <p>Keying</p> <ul style="list-style-type: none"> • Factory- and field-installed keying 	<ul style="list-style-type: none"> No cost –\$50 +\$95 	<ul style="list-style-type: none"> Specify <i>with 9250 Ember Chrome lock</i>. Specify <i>with no lock</i>. Specify <i>with individual drawer lock</i>. ▶ Page C262

Specification Information

Dimensions			Type of	Style	Base
D	W	H	Pull	Number	Price

Two File Drawers

23½"	15"	27"	Waterfall	ZUFF24WWOM	\$736
23½"	15"	27"	Rod	ZUFF24WROM	\$736
23½"	15"	27"	Contemporary	ZUFF24WCOM	\$745
29½"	15"	27"	Waterfall	ZUFF30WWOM	\$803
29½"	15"	27"	Rod	ZUFF30WROM	\$803
29½"	15"	27"	Contemporary	ZUFF30WCOM	\$812

Two Box Drawers and One File Drawer

23½"	15"	27"	Waterfall	ZUBBF24WWOM	\$736
23½"	15"	27"	Rod	ZUBBF24WROM	\$736
23½"	15"	27"	Contemporary	ZUBBF24WCOM	\$745
29½"	15"	27"	Waterfall	ZUBBF30WWOM	\$803
29½"	15"	27"	Rod	ZUBBF30WROM	\$803
29½"	15"	27"	Contemporary	ZUBBF30WCOM	\$812

Metal Pedestals with Wood Drawer Fronts and On-Module Filler

SIN 711.1

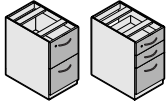

Tip: Pedestals are used in on-module positions.

Tip: Pedestals can be converted to off-module pedestals through Service Parts.

Standard Includes	Required to Specify
<ul style="list-style-type: none"> • Pedestal: paint price group 1 • Drawer fronts: wood veneer • Waterfall, Rod, or Contemporary pulls • Full drawer interiors: black only <ul style="list-style-type: none"> – Full-depth drawer body – Full extension drawer suspensions – One pencil tray per box/box/file, box drawer dividers, and adjustable file rails • Lock, keyed random: 9201 Polished Chrome • Four adjustable leveling glides • On-module filler 	<ol style="list-style-type: none"> 1 Style number 2 Paint color number for pedestal 3 Wood veneer color number for drawer fronts 4 Surface material for pull 5 Options, if selected (see below) <ul style="list-style-type: none"> ▶ See <i>Surface Materials</i>, page C252.

Options	Price	Required to Specify
Surface Materials <ul style="list-style-type: none"> • Paint price group 1 • Paint price group 2 • Paint price group 3 • Customiz stain on wood veneer 	No cost +\$38 +\$65 +\$12	Specify paint color number. Specify paint color number. Specify paint color number. Specify <i>with Customiz Stain</i> . ▶ See <i>Surface Materials Reference Manual</i> .
Pulls <p>Waterfall and rod pulls</p> <ul style="list-style-type: none"> • Paint • Plated metal <p>Contemporary pulls</p> <ul style="list-style-type: none"> • Plated metal 	No cost +\$13 per drawer No cost	Specify paint color number. Specify plated metal color number. Specify plated metal color number: 0835 Black 9201 Polished Chrome 9211 Nickel 9212 Silver
Filler <ul style="list-style-type: none"> • No filler 	–\$25	Specify <i>with no filler</i> .
Lock and Keying <p>Lock</p> <ul style="list-style-type: none"> • Ember Chrome • No lock <p>Individual locking drawers</p> <ul style="list-style-type: none"> • File/file pedestals only <p>Keying</p> <ul style="list-style-type: none"> • Factory- and field-installed keying 	No cost –\$50 +\$95	Specify <i>with 9250 Ember Chrome lock</i> . Specify <i>with no lock</i> . Specify <i>with individual drawer lock</i> . ▶ Page C262

Specification Information

Dimensions			Type of	Style	Base
D	W	H	Pull	Number	Price

Two File Drawers

23½"	15"	27"	Waterfall	ZUFF24MWW	\$736
23½"	15"	27"	Rod	ZUFF24MWR	\$736
23½"	15"	27"	Contemporary	ZUFF24MWC	\$745
29½"	15"	27"	Waterfall	ZUFF30MWW	\$803
29½"	15"	27"	Rod	ZUFF30MWR	\$803
29½"	15"	27"	Contemporary	ZUFF30MWC	\$812

Two Box and One File Drawer

23½"	15"	27"	Waterfall	ZUBBF24MWW	\$736
23½"	15"	27"	Rod	ZUBBF24MWR	\$736
23½"	15"	27"	Contemporary	ZUBBF24MWC	\$745
29½"	15"	27"	Waterfall	ZUBBF30MWW	\$803
29½"	15"	27"	Rod	ZUBBF30MWR	\$803
29½"	15"	27"	Contemporary	ZUBBF30MWC	\$812

Wood Veneer Freestanding Lateral Files

SIN 711.1

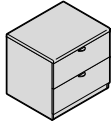

Tip: Front edge profile options are not available on four-drawer lateral files.

Tip: When you add more than one suffix to style number, always add the **L** suffix first.

Tip: Four-drawer lateral file comes standard with lock. An **"L"** suffix for the lock option is not required.

Tip: Lateral files can be used in off-module positions.

Standard Includes	Required to Specify
<ul style="list-style-type: none"> Two-drawer lateral file with square profile (Q): wood veneer Four-drawer lateral file with face lock Drawer pulls One hanging file folder frame per file drawer: black plastic only Counterweight package 	<ol style="list-style-type: none"> Style number Wood veneer color number for lateral file Drawer pull shape and finish number Options, if selected (see below) <p>▶ See <i>Surface Materials</i>, page C252.</p>

Options	Price	Required to Specify
Surface Materials <ul style="list-style-type: none"> Customiz stain on wood 	Prices at right	Specify with <i>Customiz stain</i> . ▶ See <i>Surface Materials Reference Manual</i> .
Front Edge Profile on Two-Drawer File <ul style="list-style-type: none"> Radius profile (R) Double Bullnose profile (D) Notched profile (N) Waterfall profile (W) 	No cost Prices at right Prices at right Prices at right	Specify with <i>Radius profile</i> . Specify with <i>Double Bullnose profile</i> . Specify with <i>Notched profile</i> . Specify with <i>Waterfall profile</i> .
Lock and Keying <ul style="list-style-type: none"> Lock <ul style="list-style-type: none"> Lock, keyed random: 9250 Ember Chrome Lock <ul style="list-style-type: none"> Antique Bronze Polished Chrome Keying <ul style="list-style-type: none"> Factory- and field-installed keying 	+\$50 No cost No cost	Add suffix L to style number. Specify with <i>9230 Antique Bronze lock</i> . Specify with <i>9201 Polished Chrome lock</i> . ▶ Page C262
Drawer Pull Shape <ul style="list-style-type: none"> Lip drawer pull Flush drawer pull Crescent drawer pull Contemporary drawer pull Traditional drawer pull Bow drawer pull Rail drawer pull 	No cost No cost +\$22 each +\$22 each +\$22 each +\$22 each +\$22	Specify with <i>lip drawer pull E030</i> and select 0835 Black, 9201 Polished Chrome, or 9230 Antique Bronze. Specify with <i>flush drawer pull E020</i> and select 0835 Black, 9201 Polished Chrome, or 9230 Antique Bronze. Specify with <i>crescent drawer pull E040</i> and select 0835 Black, 9201 Polished Chrome, 9230 Antique Bronze, or 9213 Polished Nickel. Specify with <i>contemporary drawer pull E070</i> and select 0835 Black, 9201 Polished Chrome, or 9212 Silver. Specify with <i>traditional drawer pull E080</i> and select 9230 Antique Bronze. Specify with <i>bow drawer pull E060</i> and select 0835 Black or 9211 Nickel. Specify with <i>rail drawer pull E050</i>

Edge Profiles Available on Two-Drawer File Only

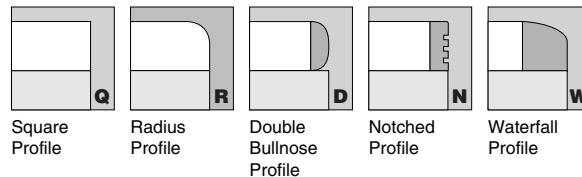

Drawer Pull Shape

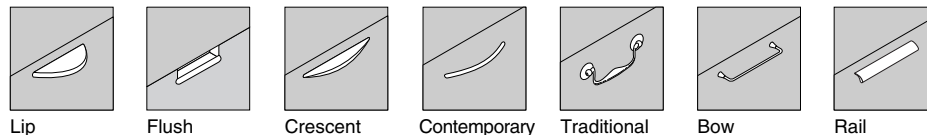

Specification Information

Style Number	Base Price			Option (Add \$ to Base Price)
	Profile Q and R	Profile D and N	Profile W	Customiz Stain

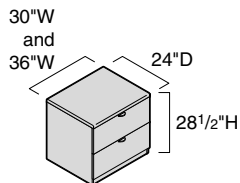

Two-Drawer Lateral File

ZEL2W	\$1665	\$1709	\$1716	+\$128
ZEL2436W	\$1900	\$1944	\$1951	+\$128

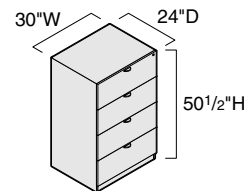

Four-Drawer Lateral File

ZEL4W	\$2412	N.A.	N.A.	+\$212
--------------	--------	------	------	--------



Wood Veneer Mobile Pedestal

SIN 711.1



Standard Includes	Required to Specify
<ul style="list-style-type: none"> • Mobile pedestal: wood veneer • Drawer pulls • One hanging file folder frame per file drawer: black plastic only • One partition per box drawer: black plastic only • Four non-locking casters: black plastic only • Lock, keyed random: 9250 Ember Chrome 	<ol style="list-style-type: none"> 1 Style number 2 Wood veneer color number for mobile pedestal 3 Drawer pull shape and finish number 4 Options, if selected (see below) <p>▶ See <i>Surface Materials</i>, page C252.</p>

Options	Price	Required to Specify
Surface Materials <ul style="list-style-type: none"> • Customiz stain on wood 	+\$57	Specify with <i>Customiz stain</i> . ▶ See <i>Surface Materials Reference Manual</i> .
Lock and Keying <ul style="list-style-type: none"> • Polished Chrome • Antique Bronze 	No cost No cost	Specify with <i>9201 Polished Chrome lock</i> . Specify with <i>9230 Antique Bronze lock</i> .
Keying <ul style="list-style-type: none"> • Factory- and field-installed keying 		▶ Page C262

Drawer Pull Shape <ul style="list-style-type: none"> • Lip drawer pull 	No cost	Specify with <i>lip drawer pull E030</i> and select 0835 Black, 9201 Polished Chrome, or 9230 Antique Bronze.
<ul style="list-style-type: none"> • Flush drawer pull 	No cost	Specify with <i>flush drawer pull E020</i> and select 0835 Black, 9201 Polished Chrome, or 9230 Antique Bronze.
<ul style="list-style-type: none"> • Crescent drawer pull 	+\$22 each	Specify with <i>crescent drawer pull E040</i> and select 0835 Black, 9201 Polished Chrome, 9230 Antique Bronze, or 9213 Polished Nickel.
<ul style="list-style-type: none"> • Contemporary drawer pull 	+\$22 each	Specify with <i>contemporary drawer pull E070</i> and select 0835 Black, 9201 Polished Chrome, or 9212 Silver.
<ul style="list-style-type: none"> • Traditional drawer pull 	+\$22 each	Specify with <i>traditional drawer pull E080</i> and select 9230 Antique Bronze.
<ul style="list-style-type: none"> • Bow drawer pull 	+\$22 each	Specify with <i>bow drawer pull E060</i> and select 0835 Black or 9211 Nickel.
<ul style="list-style-type: none"> • Rail drawer pull 	+\$22 each	Specify with <i>rail drawer pull E050</i> and select 0835 Black or 9211 Nickel.

▶ Options continued on next page

Drawer Pull Shape

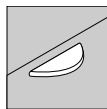

Lip

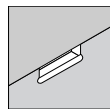

Flush

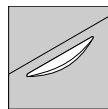

Crescent

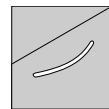

Contemporary

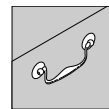

Traditional

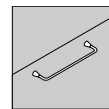

Bow

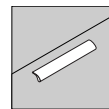

Rail

► Options continued from previous page

Options	Price	Required to Specify
Cushion Top	• Cushion top for use on mobile pedestals	+\$114 (fabric price group 1)
		Add suffix S to style number and specify fabric color number.
	Upholstery	
	• Fabric price group 1	No cost
	• Fabric price group 2	+\$ 10
	• Fabric price group 3	+\$ 33
	• Fabric price group 4	+\$ 41
	• Fabric price group 5	+\$ 50
	• Fabric price group 6	+\$ 72
	• Fabric price group 7	+\$ 85
	• Fabric price group 8	+\$125
	• Fabric price group 9	+\$160
	• Fabric price group 10	+\$195
	• Leather price group	+\$200
	• Customer's own material (COM) or Customer's own leather (COL)	+\$ 15
		Specify fabric color number. Specify fabric color number. Specify fabric color number. Specify fabric color number. Specify fabric color number. Specify fabric color number. Specify fabric color number. Specify fabric color number. Specify fabric color number. Specify fabric color number. Specify leather color number. ► See <i>Surface Materials</i> , page C252. ► See <i>Surface Materials Reference Manual</i> to specify.
Related Products	• Frame-supported end panels	► Page C185

Specification Information

Dimensions			Style	Base
D	W	H	Number	Price
19"	15½"	26"	ZMPW	\$950



Wood Veneer Smart Mobile Pedestal

SIN 711.1



Standard Includes	Required to Specify
<ul style="list-style-type: none"> • Mobile pedestal: wood veneer • Storage areas: wood veneer • Insert tray in top: black plastic only • Drawer pull • One hanging file folder frame per file drawer: black plastic only • Two locking and two non-locking casters: black plastic only • Lock, keyed random: 9250 Ember Chrome 	<ol style="list-style-type: none"> 1 Style number 2 Wood veneer color number for mobile pedestal 3 Drawer pull shape and finish number 4 Options, if selected (see below) <p>▶ See <i>Surface Materials</i>, page C252.</p>

Options	Price	Required to Specify
Surface Materials <ul style="list-style-type: none"> • Customiz stain on wood 	+\$75	Specify with <i>Customiz stain</i> . ▶ See <i>Surface Materials Reference Manual</i> .
Lock and Keying <p>Alternative lock color</p> <ul style="list-style-type: none"> • Polished Chrome • Antique Bronze <p>Keying</p> <ul style="list-style-type: none"> • Factory- and field-installed keying 	No cost No cost	Specify with <i>9201 Polished Chrome lock</i> . Specify with <i>9230 Antique Bronze lock</i> . ▶ Page C262
Drawer Pull Shape <ul style="list-style-type: none"> • Lip drawer pull • Flush drawer pull • Crescent drawer pull • Contemporary drawer pull • Traditional drawer pull • Bow drawer pull • Rail drawer pull 	No cost No cost +\$22 each +\$22 each +\$22 each +\$22 each +\$22 each	Specify with <i>lip drawer pull E030</i> and select 0835 Black, 9201 Polished Chrome, or 9230 Antique Bronze. Specify with <i>flush drawer pull E020</i> and select 0835 Black, 9201 Polished Chrome, or 9230 Antique Bronze. Specify with <i>crescent drawer pull E040</i> and select 0835 Black, 9201 Polished Chrome, 9230 Antique Bronze, or 9213 Polished Nickel. Specify with <i>contemporary drawer pull E070</i> and select 0835 Black, 9201 Polished Chrome, or 9212 Silver. Specify with <i>traditional drawer pull E080</i> and select 9230 Antique Bronze. Specify with <i>bow drawer pull E060</i> and select 0835 Black or 9211 Nickel. Specify with <i>rail drawer pull E050</i> and select 0835 Black or 9211 Nickel.

Specification Information				
Dimensions			Style Number	Base Price
D	W	H		
31¾"	31¾"	26"	ZESPW	\$1426

Drawer Pull Shape

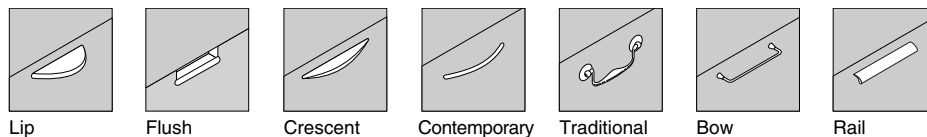

Wood Veneer Smart Mobile Pedestal with Open Shelves

Wood Veneer
Smart Mobile Pedestal
with Open Shelves

SIN 711.1



Standard Includes	Required to Specify
<ul style="list-style-type: none"> • Mobile pedestal: wood veneer • Storage areas: wood veneer • Insert tray in top: black plastic only • Two locking and two non-locking casters: black plastic only 	<ol style="list-style-type: none"> 1 Style number 2 Wood veneer color number for mobile pedestal 3 Options, if selected (see below) <p>▶ See <i>Surface Materials</i>, page C252.</p>

Options	Price	Required to Specify
Surface Materials <ul style="list-style-type: none"> • Customiz stain on wood 	+\$75	Specify <i>with Customiz stain</i> . ▶ See <i>Surface Materials Reference Manual</i> .

Specification Information

• Dimensions			• Style	• Base
D	W	H	Number	Price
31¾"	31¾"	26"	ZESPWS	\$1540
:	:	:	:	:

Montage

Wood Veneer Standing-Height Mobile Cabinet

SIN 711.1

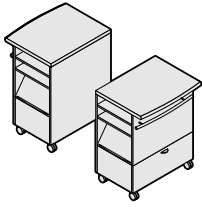

Standard Includes	Required to Specify
-------------------	---------------------

- Mobile cabinet: wood veneer
- One lateral file drawer
- Two display shelves
- Four shelves
- Drawer pull
- Storage handle: black paint
- Two locking and two non-locking casters: black plastic only

- 1 Style number with appropriate edge-profile suffix
▶ See edge-profile suffixes at bottom of page.
- 2 Wood veneer color number for mobile cabinet
- 3 Drawer pull shape and finish number
- 4 Options, if selected (see below)
▶ See *Surface Materials*, page C252.

Options	Price	Required to Specify
---------	-------	---------------------

Surface Materials	• Customiz stain on wood	+\$173	Specify with <i>Customiz stain</i> . ▶ See <i>Surface Materials Reference Manual</i> .
	• Full-fill finish on wood worksurface only	+\$ 75	Specify with <i>full-fill finish</i> .
Drawer Pull Shape	• Lip drawer pull	No cost	Specify with <i>lip drawer pull E030</i> and select 0835 Black, 9201 Polished Chrome, or 9230 Antique Bronze.
	• Flush drawer pull	No cost	Specify with <i>flush drawer pull E020</i> and select 0835 Black, 9201 Polished Chrome, or 9230 Antique Bronze.
	• Crescent drawer pull	+\$ 22 each	Specify with <i>crescent drawer pull E040</i> and select 0835 Black, 9201 Polished Chrome, 9230 Antique Bronze, or 9213 Polished Nickel.
	• Contemporary drawer pull	+\$ 22 each	Specify with <i>contemporary drawer pull E070</i> and select 0835 Black, 9201 Polished Chrome, or 9212 Silver.
	• Traditional drawer pull	+\$ 22 each	Specify with <i>traditional drawer pull E080</i> and select 9230 Antique Bronze.
	• Bow drawer pull	+\$ 22 each	Specify with <i>bow drawer pull E060</i> and select 0835 Black or 9211 Nickel.
	• Rail drawer pull	+\$ 22 each	Specify with <i>rail drawer pull E050</i> and select 0835 Black or 9211 Nickel.

Tip: If you specify 9201 Polished Chrome or 9213 Polished Nickel drawer pulls, the color of the storage handles will match the pulls. Otherwise, the storage handles will be black.

Tip: Depth dimension does not include bow front.



Edge Profile Location

Tip: Your specification is not complete until you add a suffix to define the work-surface's edge profile.

Tip: The edge profiles for wood veneer standing-height mobile cabinet are wood veneer (Q) and wood (B, D, N, and W).

Edge Profiles

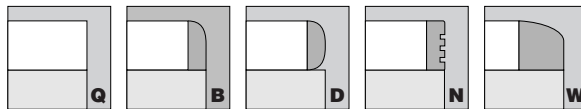

Square Profile (standard) Bullnose Profile Double Bullnose Profile Notched Profile Waterfall Profile

Drawer Pull Shape

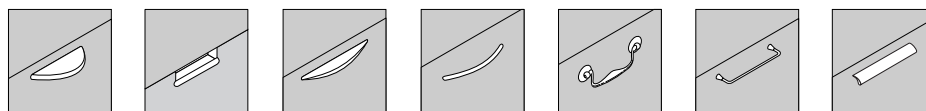

Lip Flush Crescent Contemporary Traditional Bow Rail

Specification Information

• Height	• Style Number	• Base Prices		
		Profile Q	Profile B, D, and N	Profile W
41 1/4"	ZESMCV__	\$2444	\$2680	\$2941
:	:	:	:	:

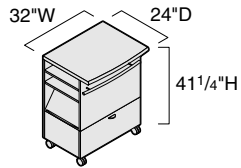

Wood Veneer Overhead Storage Shelves

SIN 711.1

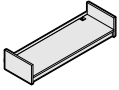

Tip: Shelves are used in on-module positions only.

Standard Includes	Required to Specify
<ul style="list-style-type: none"> Shelf: wood veneer Two grommets: black plastic only Attachment hardware for shelf light: black paint only Attachment hardware: black paint only 	<ul style="list-style-type: none"> 1 Style number 2 Wood veneer color number for shelf 3 Options, if selected (see below) ▶ See <i>Surface Materials</i>, page C252.

Options	Price	Required to Specify
Surface Materials <ul style="list-style-type: none"> Customiz stain on wood 	Prices below	Specify with <i>Customiz stain</i> . ▶ See <i>Surface Materials Reference Manual</i> .
Related Products <ul style="list-style-type: none"> Vertical wire managers Lighting 		▶ Page C234 ▶ Page C237

Specification Information

• Dimensions			• Style	• Base	• Option
D	W	H	Number	Price	(Add \$ to Base Price)
15¾"	24"	9¾"	ZEBS24W	\$353	+\$50
15¾"	30"	9¾"	ZEBS30W	\$387	+\$50
15¾"	36"	9¾"	ZEBS36W	\$418	+\$50
15¾"	42"	9¾"	ZEBS42W	\$431	+\$50
15¾"	48"	9¾"	ZEBS48W	\$445	+\$50
15¾"	60"	9¾"	ZEBS60W	\$509	+\$50

Wood Veneer Organizer Shelves

Wood Veneer
Organizer Shelves

SIN 711.1

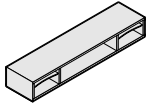

Tip: Shelves are used in on-module positions only.

Standard Includes	Required to Specify
<ul style="list-style-type: none"> Organizer shelf: wood veneer Attachment hardware: black paint only 	<ul style="list-style-type: none"> 1 Style number 2 Wood veneer color number for shelf 3 Options, if selected (see below) ▶ See <i>Surface Materials</i>, page C252.

Options	U.S.	Zone 1	Zone 2	Required to Specify
<ul style="list-style-type: none"> Customiz stain on wood 	Prices below			<ul style="list-style-type: none"> Specify with <i>Customiz stain</i>. ▶ See <i>Surface Materials Reference Manual</i>.

Specification Information				
• Dimensions	• Style		• Base	• Option
D W H	Number		Price	(Add \$ to Base Price)
:	:	:	:	Customiz Stain

For Use with 24"D Worksurfaces

11½"	24"	9"	ZEORG1224W	\$ 495	+\$ 50
11½"	30"	9"	ZEORG1230W	\$ 543	+\$ 50
11½"	36"	9"	ZEORG1236W	\$ 570	+\$ 50
11½"	42"	9"	ZEORG1242W	\$ 660	+\$ 50
11½"	48"	9"	ZEORG1248W	\$ 734	+\$ 50
11½"	60"	9"	ZEORG1260W	\$ 740	+\$ 50
11½"	66"	9"	ZEORG1266W	\$ 865	+\$100
11½"	72"	9"	ZEORG1272W	\$ 990	+\$100

For Use with 30"D Worksurfaces

15"	24"	9"	ZEORG1524W	\$ 779	+\$ 50
15"	30"	9"	ZEORG1530W	\$ 817	+\$ 50
15"	36"	9"	ZEORG1536W	\$ 856	+\$ 50
15"	42"	9"	ZEORG1542W	\$ 993	+\$ 50
15"	48"	9"	ZEORG1548W	\$1099	+\$ 50
15"	60"	9"	ZEORG1560W	\$1111	+\$ 50
15"	66"	9"	ZEORG1566W	\$1295	+\$100
15"	72"	9"	ZEORG1572W	\$1478	+\$100

Montage

Wood Veneer Overhead Storage Cabinets

SIN 711.1

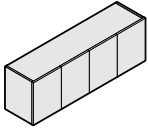

Tip: Cabinets can be mounted off module by ordering off-module bin brackets, see below.

Tip: Maximum width when mounting cabinets off module is 48".

Tip: Off-module upper storage brackets cannot span a vertical frame rail or joint.

Tip: You cannot mount more than two pairs of off-module brackets and associated storage per off-module frame.

Standard Includes	Required to Specify
<ul style="list-style-type: none"> Overhead storage cabinet with doors: wood veneer Two grommets: black plastic only Attachment hardware for shelf light: black paint only Attachment hardware: black paint only Lock, if selected, keyed random: 9250 Ember Chrome On-module overhead storage cabinet brackets: all paint price groups 	<ol style="list-style-type: none"> Style number Wood veneer color number for overhead storage cabinet and off-module brackets Options, if selected (see below) <ul style="list-style-type: none"> ▶ See <i>Surface Materials</i>, page C252.

Options	Price	Required to Specify
Surface Materials <ul style="list-style-type: none"> Customiz stain on wood 	Prices below	Specify with <i>Customiz stain</i> . ▶ See <i>Surface Materials Reference Manual</i> .
Lock and Keying <ul style="list-style-type: none"> Lock <ul style="list-style-type: none"> Lock, keyed random: 9250 Ember Chrome Alternative lock color <ul style="list-style-type: none"> Polished Chrome Antique Bronze Keying <ul style="list-style-type: none"> Factory- and field-installed keying 	+\$50 each No cost No cost	Add suffix L to style number. Specify with <i>9201 Polished Chrome lock</i> . Specify with <i>9230 Antique Bronze lock</i> . ▶ Page C262
Grommets <ul style="list-style-type: none"> Round grommet: black plastic only 	+\$29 each	Left: specify with <i>E91AMBL</i> . Right: specify with <i>E91AMBR</i> .
Related Products <ul style="list-style-type: none"> Vertical wire managers Lighting 		▶ Page C234 ▶ Page C237

Specification Information						
• Dimensions			• Number of Locks (If selected)	• Style Number	• Base Price	• Option (Add \$ to Base Price) Customiz Stain
D	W	H				
16½"	24"	16½"	1	ZEBB24W	\$ 653	+\$79
16½"	30"	16½"	1	ZEBB30W	\$ 779	+\$79
16½"	36"	16½"	1	ZEBB36W	\$ 980	+\$79
16½"	42"	16½"	2	ZEBB42W	\$1044	+\$79
16½"	48"	16½"	2	ZEBB48W	\$1173	+\$79
16½"	60"	16½"	2	ZEBB60W	\$1519	+\$79
:	:	:	:	:	:	:

Related Products	
• Style Number	• Price
:	:

Off-Module Attachment Brackets

ZBBWOM	\$95
:	:

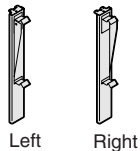

Wood Veneer Service Modules

SIN 711.1

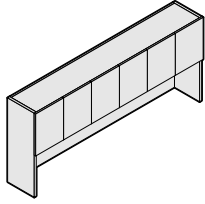

Standard Includes	Required to Specify
<ul style="list-style-type: none"> • Service module: wood veneer • Two grommets: black plastic only • Finished back • Attachment hardware for shelf light: black paint only • Two vertical wire managers: black plastic only • Attachment hardware: black paint only 	<ol style="list-style-type: none"> 1 Style number 2 Wood veneer color number for service module 3 Options, if selected (see below) <ul style="list-style-type: none"> ▶ See <i>Surface Materials</i>, page C252.

Options	Price	Required to Specify
Surface Materials <ul style="list-style-type: none"> • Customiz stain on wood 	Prices below	Specify <i>with Customiz stain</i> . ▶ See <i>Surface Materials Reference Manual</i> .
Lock and Keying <ul style="list-style-type: none"> • Lock • Lock, keyed random: 9250 Ember Chrome 	+\$50 each	Add suffix L to style number.
<ul style="list-style-type: none"> • Alternative lock color • Polished Chrome • Antique Bronze 	No cost No cost	Specify <i>with 9201 Polished Chrome lock</i> . Specify <i>with 9230 Antique Bronze lock</i> .
<ul style="list-style-type: none"> • Keying • Factory- and field-installed keying 		▶ Page C262
Related Products <ul style="list-style-type: none"> • Tackboards • Lighting 		▶ Page C224 ▶ Page C237

Specification Information						
• Dimensions	• Number	• Number	• Style	• Base	• Option	
D W	of Doors	of Locks	Number	Price	(Add \$ to Base Price)	
					Customiz Stain	
15½" 60"	4	2	ZESM60W	\$2171	+\$239	
15½" 66"	4	2	ZESM66W	\$2315	+\$239	
15½" 72"	4	2	ZESM72W	\$2459	+\$239	
15½" 90"	6	3	ZESM90W	\$2886	+\$239	
:	:	:	:	:	:	

Tip: Worksurface to underside of service module is 20½"H and allows for larger monitors or computer screens.

Montage

Service Module Tackboards

for Use with Service Modules

SIN 711.1

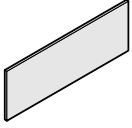

Tip: Tackboards larger than 60"W are shipped in two pieces.

Standard Includes	Required to Specify
-------------------	---------------------

- Tackboard: vertical surface fabric price group 1
- Attachment hardware

- 1 Style number
- 2 Fabric color number
- 4 Options, if selected (see below)
- ▶ See *Surface Materials*, page C252.

Surface Materials	Options	Price	Required to Specify
-------------------	---------	-------	---------------------

- | | | | |
|--------------------------|--------------------------|---------|---|
| Surface Materials | • Fabric price group 1 | No cost | Specify fabric color number.
Specify fabric color number.
Specify fabric color number.
Specify fabric color number.
Specify fabric color number.
▶ See <i>Surface Materials Reference Manual</i> to specify. |
| | • Fabric price group 2 | +\$ 8 | |
| | • Fabric price group 3 | +\$ 46 | |
| | • Fabric price group 4 | +\$ 62 | |
| | • Fabric price group 5 | +\$100 | |
| | • Fabric price group COM | +\$ 13 | |

Specification Information			
Dimensions		Style Number	Base Price
W	H		

60"	19 ³ / ₄ "	ZETB60	\$162
66"	19 ³ / ₄ "	ZETB66	\$175
72"	19 ³ / ₄ "	ZETB72	\$188
90"	19 ³ / ₄ "	ZETB90	\$228
:	:	:	:

SIN 711.1

Wood Veneer Vertical Cabinets

SIN 711.1

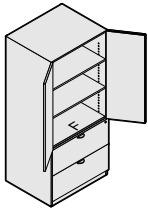

Standard Includes	Required to Specify
<ul style="list-style-type: none"> Vertical cabinet: wood veneer Finished back Pulls Lock, if selected, keyed random: 9250 Ember Chrome Self-closing hinges on doors Two rails per file drawer: black only 	<ol style="list-style-type: none"> Style number Wood veneer color number for cabinet Door and drawer pull shape finish number Options, if selected (see below) <p>▶ See <i>Surface Materials</i>, page C252.</p>

Options	Price	Required to Specify
Surface Materials <ul style="list-style-type: none"> Customiz stain on wood 	Prices at right	Specify with <i>Customiz stain</i> . ▶ See <i>Surface Materials Reference Manual</i> .
Lock and Keying <ul style="list-style-type: none"> Alternative lock color <ul style="list-style-type: none"> Polished Chrome Antique Bronze Keying <ul style="list-style-type: none"> Factory- and field-installed keying 	No cost No cost	Specify with <i>9201 Polished Chrome lock</i> . Specify with <i>9230 Antique Bronze lock</i> . ▶ Page C262

Door and Drawer Pull Shape	• Lip drawer pull	No cost	Specify with <i>lip drawer pull E030</i> and select 0835 Black, 9201 Polished Chrome, or 9230 Antique Bronze.
	• Flush pulls	No cost	Specify with <i>flush pull E020</i> and select 0835 Black, 9201 Polished Chrome, or 9230 Antique Bronze.
	• Crescent pulls	+\$22 each	Specify with <i>crescent pull E040</i> and select 0835 Black, 9201 Polished Chrome, 9230 Antique Bronze, or 9213 Polished Nickel.
	• Contemporary pulls	+\$22 each	Specify with <i>contemporary pull E070</i> and select 0835 Black, 9201 Polished Chrome, or 9212 Silver.
	• Traditional pulls	+\$22 each	Specify with <i>traditional pull E080</i> and select 9230 Antique Bronze.
	• Bow pulls	+\$22 each	Specify with <i>bow pull E060</i> and select 0835 Black or 9211 Nickel.
	• Rail pulls	+\$22 each	Specify with <i>rail pull E050</i> and select 0835 Black or 9211 Nickel.

Door and Drawer Pull Shapes

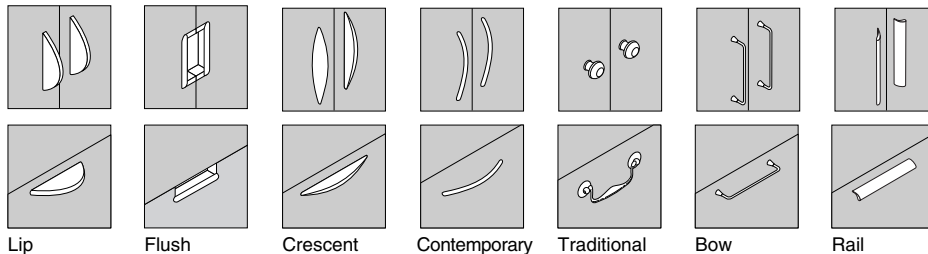

Lip Flush Crescent Contemporary Traditional Bow Rail

Specification Information

Dimensions			Number of Shelves	Style Number	Base Price	Option (Add \$ to Base Price)
D	W	H				
:	:	:	:	:	:	Customiz Stain

With Two File Drawers Below and Closed Storage Above

24"	30"	66"	1 fixed, 2 adjustable	ZEVC2F2D	\$2976	+\$445
:	:	:	:	:	:	:

With Full Storage

24"	30"	66"	2 fixed, 3 adjustable	ZEVC	\$2625	+\$445
:	:	:	:	:	:	:

With Wardrobe Storage with Full Coat Rod

24"	30"	66"	N.A.	ZEVCWARD	\$2305	+\$445
:	:	:	:	:	:	:

With Shelves Right and Wardrobe Storage Left

24"	30"	66"	2 fixed, 3 adjustable	ZEVCSRWL	\$2482	+\$445
:	:	:	:	:	:	:

With Shelves Left and Wardrobe Storage Right

24"	30"	66"	2 fixed, 3 adjustable	ZEVCSLWR	\$2482	+\$445
:	:	:	:	:	:	:

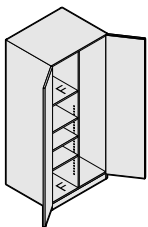
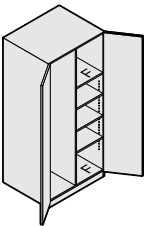
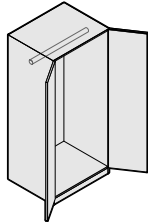
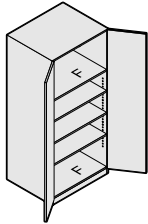
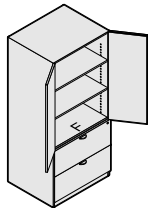

F = Fixed shelf

Montage

Wood Veneer Worksurfaces

for Use Above 50½"H Lateral File

SIN 711.1

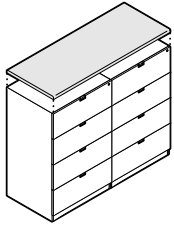

Standard Includes

- Worksurface: wood veneer
- Edge profile on front edge: wood, except square and radius profiles which are wood veneer
- Non-locking

Required to Specify

- 1 Style number with appropriate edge-profile suffix
- ▶ See edge-profile suffixes at bottom of page.
- 2 Wood veneer color number
- 3 Options, if selected (see below)
- ▶ See *Surface Materials*, page C252.

Options

Surface Materials

- Full-fill finish
Prices below
- Customiz stain on wood
Prices below

Required to Specify

- Specify *with full-fill finish* and select wood veneer color number.
Specify *with Customiz stain*.
▶ See *Surface Materials Reference Manual*.

Related Products

- 50½"H lateral file
▶ Page C212

Specification Information

Dimensions		Style Number	Base Price			Option (Add \$ to Base Price)
D	W		Profile Q and R	Profile D and N	Profile W	
24"D	30½" W	ZEW1VCW __	\$157	\$203	\$212	+\$24
24"D	60½" W	ZEW2VCW __	\$453	\$586	\$608	+\$60
24"D	90¾" W	ZEW3VCW __	\$727	\$941	\$977	+\$60



Edge Profile Location

Tip: Your specification is not complete until you add a suffix to define the worksurface's edge profile.

Tip: On a wood veneer worksurface, the bullnose (B) profile is not available.

Edge Profiles

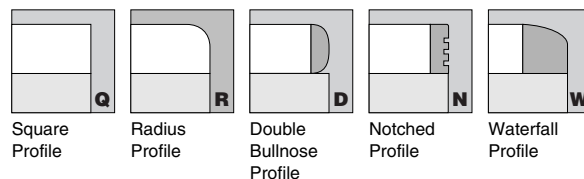

Wood Veneer Bookcases

SIN 711.1

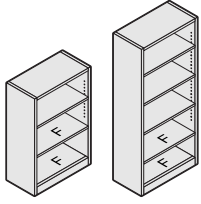

Standard Includes	Required to Specify
<ul style="list-style-type: none"> Bookcase: wood veneer Finished back 	<ul style="list-style-type: none"> 1 Style number 2 Wood veneer color number 3 Options, if selected (see below) ▶ See <i>Surface Materials</i>, page C252.

Options	Price	Required to Specify
Surface Materials <ul style="list-style-type: none"> Customiz stain on wood 	Prices below	Specify with <i>Customiz stain</i> . ▶ See <i>Surface Materials Reference Manual</i> .

Specification Information						
Dimensions			Number of Shelves	Style Number	Base Price	Option (Add \$ to Base Price)
D	W	H				
15"	30"	45"	2 fixed, 1 adjustable	ZEBC3045W	\$1953	+\$155
15"	30"	66"	2 fixed, 3 adjustable	ZEBC3065W	\$2176	+\$288
:	:	:	:	:	:	:

Montage

Wood Top Caps

SIN 711.1

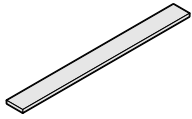

Top Cap



Junction Top Cap

Tip: All wood top caps have a square edge profile.

Tip: Wood top cap for junction package includes an aluminum junction bracket for proper alignment.

Tip: Top caps are solid wood and offered in wood finishes that match natural open-pore veneer finishes.

Tip: Wood junction top cap is already included with wood junction frame kit.

Tip: The fifth digit of the wood junction top cap style number indicates the junction (L, T, or X) to be used in the application.

Standard Includes	Required to Specify
<ul style="list-style-type: none"> • Top caps: solid wood • Junction top cap: solid wood 	1 Style number 2 Wood color number for top cap 3 Options, if selected (see below) ▶ See <i>Surface Materials</i> , page C252.

Options	Price	Required to Specify
Surface Materials <ul style="list-style-type: none"> • Customiz stain on wood 	Prices below	Specify with <i>Customiz stain</i> . ▶ See <i>Surface Materials Reference Manual</i> .
Related Products <ul style="list-style-type: none"> • Frame junction kits • Wood tiles 		▶ Page C53 ▶ Page C116

Specification Information			
Width	Style Number	Base Price	Option (Add \$ to Base Price)
..... Customiz Stain

Wood Top Caps

24"	ZTC24W	\$94	+\$11
30"	ZTC30W	\$94	+\$12
36"	ZTC36W	\$94	+\$12
42"	ZTC42W	\$94	+\$13
48"	ZTC48W	\$94	+\$13
.....

Wood Junction Top Cap

3"	ZTCJL3W	\$45	+\$11
3"	ZTCJT3W	\$45	+\$11
3"	ZTCJX3W	\$45	+\$11
.....

Wood Vertical End Trim

SIN 711.1



Tip: Vertical end trim is solid wood and offered in wood finishes that match natural open-pore veneer finishes.

Standard Includes	Required to Specify
<ul style="list-style-type: none"> Vertical end trim: solid wood 	1 Style number 2 Wood color number for vertical end trim 3 Options, if selected (see below) ▶ See <i>Surface Materials</i> , page C252.

Options	Price	Required to Specify
Surface Materials <ul style="list-style-type: none"> Customiz stain on wood 	Prices below	Specify <i>with Customiz stain</i> . ▶ See <i>Surface Materials Reference Manual</i> .
Related Products <ul style="list-style-type: none"> Frame junction kits Wood tiles 		▶ Page C53 ▶ Page C116

Specification Information			
Height	Style Number	Base Price	Option (Add \$ to Base Price)
20"	ZET20W	\$ 85	+\$11
45"	ZET45W	\$103	+\$12
65"	ZET65W	\$103	+\$15
85"	ZET86W	\$103	+\$17
:	:	:	:



Power and Communication Accessories

SIN 711.1

Power Spheres

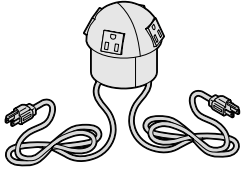

Tip: Sphere is field installed. Use 3"-diameter drill to cut mounting hole at desired location.

Standard Includes				Required to Specify
<ul style="list-style-type: none"> Sphere with four simplex electrical outlets: black plastic Two 6' power cords (each rated at 15 amps), if selected: black plastic Two 6' Greenfield conduits (each rated at 15 amps), if selected: metal 				Style number
Specification Information				
Dimensions			Style	Price
D	W	H	Number	
Four Electrical Outlets with Two 6' Power Cords				
3 ³ / ₈ "	3 ³ / ₈ "	3"	PTDMGB1	\$164
Four Electrical Outlets with Two 6' Greenfield Conduits for Hardwiring				
3 ³ / ₈ "	3 ³ / ₈ "	3"	PTDMGB2	\$283

Power and Communication Spheres

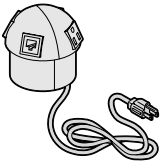

Tip: Sphere is field installed. Use 3"-diameter drill to cut mounting hole at desired location.

Tip: Face plates in sphere accommodates standard voice/data jacks. Order jacks by calling any of the manufacturers listed below:

- AMP Corporation
1.800.522.6752
- Leviton
1.800.722.2082
- Lucent
1.800.344.0223
- Krone
1.800.775.5766
- Punduit
1.800.777.3300

Standard Includes				Required to Specify
<ul style="list-style-type: none"> Sphere with two simplex electrical outlets: black plastic Face plates to accommodate two customer-supplied voice/data jacks: black plastic 6' power cord with plug rated at 15 amps, if selected: black plastic 6' Greenfield conduit for hardwiring, if selected: metal 				Style number
Specification Information				
Dimensions			Style	Price
D	W	H	Number	
Sphere with One 6' Power Cord				
3 ³ / ₈ "	3 ³ / ₈ "	3"	PTDMGB3	\$164
Sphere with One 6' Greenfield Conduit for Hardwiring				
3 ³ / ₈ "	3 ³ / ₈ "	3"	PTDMGB4	\$232

Communication Sphere



Tip: Sphere is field installed. Use 3"-diameter drill to cut mounting hole at desired location.

Tip: Order jacks by calling any of the manufacturers listed below:

- AMP Corporation
1.800.522.6752
- Leviton
1.800.722.2082
- Lucent
1.800.344.0223
- Krone
1.800.775.5766
- Punduit
1.800.777.3300

Standard Includes	Required to Specify
<ul style="list-style-type: none"> Sphere with face plates to accommodate four customer-supplied voice/data jacks: black plastic 	Style number

Specification Information

• Dimensions			• Style	• Price
D	W	H	Number	
3 3/8"	3 3/8"	3"	PTDMGB5	\$164

Round Power and Communication Port

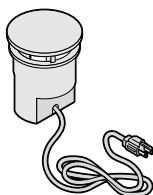

Tip: Port is field installed. Use a 3 1/2"-diameter drill to cut mounting hole at desired location.

Tip: Order jacks by calling any of the manufacturers listed below:

- AMP Corporation
1.800.522.6752
- Leviton
1.800.722.2082
- Lucent
1.800.344.0223
- Krone
1.800.775.5766
- Punduit
1.800.777.3300

Standard Includes	Required to Specify
<ul style="list-style-type: none"> Round unit with two electrical outlets: black plastic 6' power cord with plug rated at 15 amps: black plastic Adapters for two customer-supplied data couplers/jacks 	Style number

Specification Information

• Dimensions			• Style	• Price
D	W	H	Number	
4 1/4"	4 1/4"	4 5/16"	PTRSGB1	\$256

SIN 711.1

Cable and Fiber Reels

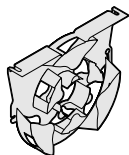

Standard Includes	Required to Specify
<ul style="list-style-type: none"> Package of four reels: black plastic only 	Style number

Specification Information

• Dimensions			• Style	• Price
D	W	H	Number	
1 1/4"	8"	8 5/16"	98766	\$87 package of 4
·	·	·	·	·

Termination Plate

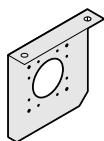

Standard Includes	Required to Specify
<ul style="list-style-type: none"> Termination plate: black paint only 	Style number

Specification Information

• Dimensions			• Style	• Price
D	W	H	Number	
3/4"	7 1/8"	7 1/8"	98765	\$14
·	·	·	·	·

Vertical Wire Managers



Standard Includes	Required to Specify
<ul style="list-style-type: none"> Vertical wire manager: 6000 Black plastic or 6659 Light Grey plastic 	Style number

Specification Information

• Height	• Style	• Price
	Number	
13"	ZWM13	\$10
20"	ZWM20	\$12
·	·	·

Power Strips

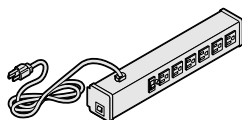

Standard Includes	Required to Specify
-------------------	---------------------

- Power strip with 6' cord and three-prong plug: grey paint only

Style number

Specification Information

• Style Number	• Price

Without Line Conditioner

88PS	\$ 68
-------------	-------

With Line Conditioner

88PSLC	\$171
---------------	-------

Cord Reels

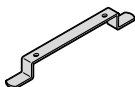

Standard Includes	Required to Specify
-------------------	---------------------

- Carton of six cord reels: grey paint only

Style number

Specification Information

• Style Number	• Price

98767	\$37
--------------	------

Cable Storage Tray

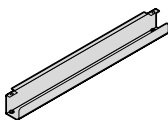

Standard Includes	Required to Specify
-------------------	---------------------

- Cable storage tray: Tan Value 1 paint only

Style number

Specification Information

• Dimensions			• Style Number	• Price
D	W	H		

2"	24"	2½"	98768	\$28
----	-----	-----	--------------	------

SIN 711.1

Wire Guide Clips



Standard Includes	Required to Specify
<ul style="list-style-type: none">• Carton of 20 adhesive-backed wire guide clips: black plastic only	Style number

Specification Information

Style Number	Price
32WCP	\$21

Specifying Montage Lighting

► For more detailed product information, see the *Montage Solutions Specification Guide* or consult your Steelcase dealer.

Lighting

Canopy Lights (SIN 711.1)	C238
Rail-Mounting Riser (SIN 711.1)	C242
Advanced Shelf Lights (SIN 711.1)	C244
Standard Shelf Lights (SIN 711.1)	C246
Utility Shelf Lights (SIN 711.1)	C248

Related Products

Vertical Wire Managers (SIN 711.1)	C250
------------------------------------	-------------

Canopy Lights

for Use with 3/4"- to 1 3/4"-Thick Worksurfaces

SIN 711.1

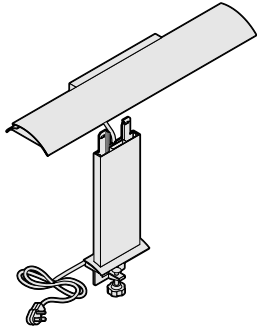

Standard Includes	Required to Specify
-------------------	---------------------

- Light housing: all paint price groups or clear anodized aluminum
- Light control box and end caps: Sterling plastic only
- On-off switch centered in control box
- 9' cord with three-prong plug at 45° angle: black vinyl only
- Precision optics tube
- Reflector: specular (reflective) aluminum
- T5 3500K lamp
- Electronic ballast
- Dimmer switch, if selected: Sterling plastic only
- Clamp mechanism
- Pair of cord manager clips: black plastic only

- 1 Style number
- 2 Paint color number or 8043 Clear Anodized Aluminum for light housing
- ▶ See *Surface Materials*, page C252.

Specification Information					
• Dimensions			• Lamp Wattage	• Style Number	• Price
D	W	H			

Electronic Ballast with Dimmer Switch

7 1/16"	24 1/4"	3 13/16"	14 watts	LCS24KR	\$550
7 1/16"	36 1/16"	3 13/16"	21 watts	LCS36KR	\$581
7 1/16"	47 7/8"	3 13/16"	28 watts	LCS48KR	\$613

With Chicago Cord Including Circuit Breaker

7 1/16"	24 1/4"	3 13/16"	14 watts	LCS24KRC	\$597
7 1/16"	36 1/16"	3 13/16"	21 watts	LCS36KRC	\$628
7 1/16"	47 7/8"	3 13/16"	28 watts	LCS48KRC	\$660

Electronic Ballast

7 1/16"	24 1/4"	3 13/16"	14 watts	LCS24K	\$475
7 1/16"	36 1/16"	3 13/16"	21 watts	LCS36K	\$506
7 1/16"	47 7/8"	3 13/16"	28 watts	LCS48K	\$538

With Chicago Cord Including Circuit Breaker

7 1/16"	24 1/4"	3 13/16"	14 watts	LCS24KC	\$522
7 1/16"	36 1/16"	3 13/16"	21 watts	LCS36KC	\$553
7 1/16"	47 7/8"	3 13/16"	28 watts	LCS48KC	\$585

Canopy Lights

SIN 711.1

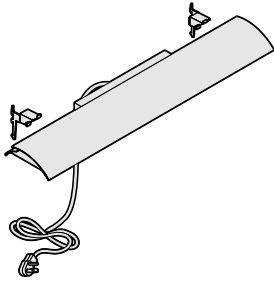

*Tip: Panel-mounted canopy lights are standard with brackets that attach to Answer, Avenir, and Series 9000 panels. You **must** select the correct brackets for use on Elective Elements, Montage, slatwall, architectural drywall, or competitive products.*

Standard Includes	Required to Specify
<ul style="list-style-type: none"> Light housing: all paint price groups or clear anodized aluminum Light control box and end caps: Sterling plastic only On-off switch centered in control box 9' cord with three-prong plug at 45° angle: black vinyl only Precision optics tube Reflector: specular (reflective) aluminum T5 3500K lamp Electronic ballast Dimmer switch, if selected: Sterling plastic only Pair of Answer, Avenir, and Series 9000 panel-mounting brackets: Sterling paint only Pair of cord manager clips: black plastic only 	<ul style="list-style-type: none"> 1 Style number 2 Paint color number or 8043 Clear Anodized Aluminum for light housing 3 Options, if selected (see below) ▶ See <i>Surface Materials</i>, page C252.

Options	Price	Required to Specify
Panel Brackets <ul style="list-style-type: none"> Pair of Montage frame-mounting brackets: Sterling paint only Pair of Elective Elements panel-mounting brackets: Sterling paint only 	No cost	Specify with <i>Montage brackets</i> .
Slatwall Brackets <ul style="list-style-type: none"> Pair of slatwall-mounting brackets: Sterling paint only 	No cost	Specify with <i>slatwall brackets</i> .
Architectural Drywall Brackets <ul style="list-style-type: none"> Pair of architectural drywall brackets: Sterling paint only 	No cost	Specify with <i>drywall brackets</i> .
Competitive Brackets <ul style="list-style-type: none"> Pair of panel-mounted brackets for use with Haworth Premise: Sterling paint only Pair of panel-mounted brackets for use with Herman Miller Action Office: Sterling paint only Pair of panel-mounted brackets for use with Herman Miller Ethospace: Sterling paint only Pair of panel-mounted brackets for use with Knoll System 6 and System Z: Sterling paint only 	No cost	Specify with <i>Haworth Premise brackets</i> . Specify with <i>Herman Miller Action Office brackets</i> . Specify with <i>Herman Miller Ethospace brackets</i> . Specify with <i>Knoll System 6 and System Z brackets</i> .

Specification Information

Dimensions			Lamp	Style	Base
D	W	H	Wattage	Number	Price

Electronic Ballast with Dimmer Switch

7 1/16"	24 1/4"	3 13/16"	14 watts	LCP24KR	\$470
7 1/16"	36 1/16"	3 13/16"	21 watts	LCP36KR	\$501
7 1/16"	47 7/8"	3 13/16"	28 watts	LCP48KR	\$533

With Chicago Cord Including Circuit Breaker

7 1/16"	24 1/4"	3 13/16"	14 watts	LCP24KRC	\$517
7 1/16"	36 1/16"	3 13/16"	21 watts	LCP36KRC	\$548
7 1/16"	47 7/8"	3 13/16"	28 watts	LCP48KRC	\$580

Electronic Ballast

7 1/16"	24 1/4"	3 13/16"	14 watts	LCP24K	\$395
7 1/16"	36 1/16"	3 13/16"	21 watts	LCP36K	\$426
7 1/16"	47 7/8"	3 13/16"	28 watts	LCP48K	\$458

With Chicago Cord Including Circuit Breaker

7 1/16"	24 1/4"	3 13/16"	14 watts	LCP24KC	\$442
7 1/16"	36 1/16"	3 13/16"	21 watts	LCP36KC	\$473
7 1/16"	47 7/8"	3 13/16"	28 watts	LCP48KC	\$505

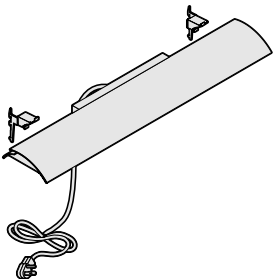
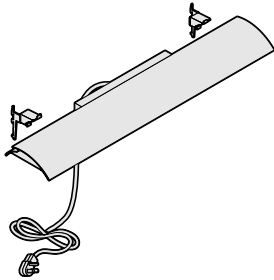

Rail-Mounting Riser

SIN 711.1



Tip: For more information about Details Workflo rail, call Details Customer Alliance at 1.800.833.0411

Standard Includes	Required to Specify
-------------------	---------------------

- | | |
|--|--------------|
| <ul style="list-style-type: none">• Riser to attach to Details Workflo: Sterling plastic only• Pair of cord manager clips: black plastic only | Style number |
|--|--------------|

Specification Information				
Dimensions			Style	Base
D	W	H	Number	Price

1"	6"	6 1/2"	LCWRIS	\$55
----	----	--------	---------------	------

Advanced Shelf Lights

SIN 711.1

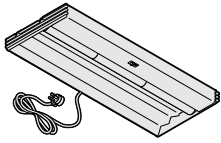

Tip: Daisy chaining is not allowed in New York City or Chicago. Local electrical codes vary, so you should consult a qualified electrical contractor or engineer for proper installation of all electrical equipment.

Tip: Because shelf lights are usually recessed, black is the standard paint color. Paint colors other than black have an upcharge.

Tip: If an optional paint color is selected for the housing, the electrical switches and end caps will remain black plastic.

Tip: Flush mounting package contains a pair of clips that allow shelf lights to be installed and removed without tools.

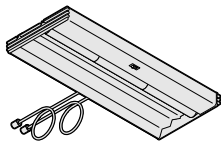
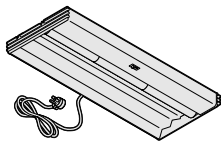

Tip: Remember to order a daisy chain starter cord. ▶ See Related Products on next page.

Standard Includes	Required to Specify
-------------------	---------------------

- Light housing with centered on-off switch: black paint
- End cap cord managers: black plastic only
- Cords:
 - 9' cord with three-prong plug at 45° angle: black vinyl only
 - One 30" and one 48" cord with modular connectors for daisy chaining: black vinyl only
- Precision optics tube around lamp
- Faceted reflector: specular (reflective) aluminum
- T8 3500K lamp
- Ballast
- Dimmer switch, if selected: black plastic only
- Universal mounting hardware package
- Daisy chain starter cord, if selected: black vinyl only (order separately)

- 1 Style number
- 2 Paint color number, if other than black (see options below)
- 3 Options, if selected (see below)
 - ▶ See *Surface Materials*, page C252.

Options	Price	Required to Specify
Surface Materials <ul style="list-style-type: none"> • Painted light housing other than black 	+\$15	Specify paint color number for housing. ▶ See <i>Surface Materials</i> , page C252.
Bracket Options <ul style="list-style-type: none"> • Competitive mounting package • Flush mounting package 	No cost	Specify <i>with competitive mounting package</i> . Specify <i>with flush mounting package</i> and paint color number for end cap covers.

Specification Information

Dimensions	Lamp	Style	Base
D W H	Wattage	Number	Price

Economizer Electronic Ballast

9 1/4"	25"	1 3/4"	17 watts	LSH24KF	\$412
9 1/4"	37"	1 3/4"	25 watts	LSH36KF	\$439
9 1/4"	49"	1 3/4"	32 watts	LSH48KF	\$458

With Chicago Cord Including Circuit Breaker

9 1/4"	25"	1 3/4"	17 watts	LSH24KFC	\$459
9 1/4"	37"	1 3/4"	25 watts	LSH36KFC	\$486
9 1/4"	49"	1 3/4"	32 watts	LSH48KFC	\$505

With Daisy Chain Cords

9 1/4"	25"	1 3/4"	17 watts	LSH24KFD	\$436
9 1/4"	37"	1 3/4"	25 watts	LSH36KFD	\$463
9 1/4"	49"	1 3/4"	32 watts	LSH48KFD	\$482

▶ **Specification information continued on next page**

▶ Continued from previous page

Specification Information

Dimensions			Lamp	Style	Base
D	W	H	Wattage	Number	Price

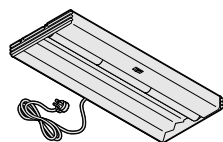

Electronic Ballast

9 1/4"	25"	1 3/4"	17 watts	LSH24K	\$373
9 1/4"	37"	1 3/4"	25 watts	LSH36K	\$400
9 1/4"	49"	1 3/4"	32 watts	LSH48K	\$419

With Chicago Cord Including Circuit Breaker

9 1/4"	25"	1 3/4"	17 watts	LSH24KC	\$420
9 1/4"	37"	1 3/4"	25 watts	LSH36KC	\$447
9 1/4"	49"	1 3/4"	32 watts	LSH48KC	\$466

With Daisy Chain Cords

9 1/4"	25"	1 3/4"	17 watts	LSH24KD	\$397
9 1/4"	37"	1 3/4"	25 watts	LSH36KD	\$424
9 1/4"	49"	1 3/4"	32 watts	LSH48KD	\$443

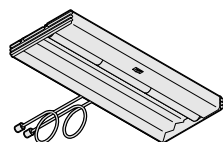

Tip: Remember to order a daisy chain starter cord.

▶ See Related Products below.

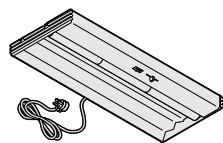

Electronic Ballast with Dimmer Switch

9 1/4"	25"	1 3/4"	17 watts	LSH24KR	\$465
9 1/4"	37"	1 3/4"	25 watts	LSH36KR	\$492
9 1/4"	49"	1 3/4"	32 watts	LSH48KR	\$511

With Chicago Cord Including Circuit Breaker

9 1/4"	25"	1 3/4"	17 watts	LSH24KRC	\$512
9 1/4"	37"	1 3/4"	25 watts	LSH36KRC	\$539
9 1/4"	49"	1 3/4"	32 watts	LSH48KRC	\$558

With Daisy Chain Cords

9 1/4"	25"	1 3/4"	17 watts	LSH24KDR	\$489
9 1/4"	37"	1 3/4"	25 watts	LSH36KDR	\$516
9 1/4"	49"	1 3/4"	32 watts	LSH48KDR	\$535

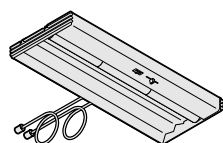

Tip: Remember to order a daisy chain starter cord.

▶ See Related Products below.



Related Products

Quantity in Package	Length	Style Number	Base Price
---------------------	--------	--------------	------------

Daisy Chain Starter Cord

1	78"	LS1FSC	\$ 40
6	78"	LS6FSC	\$240

Standard Shelf Lights

SIN 711.1

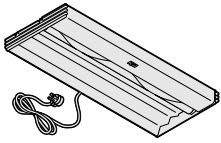

Tip: Daisy chaining is not allowed in New York City or Chicago. Local electrical codes vary, so you should consult a qualified electrical contractor or engineer for proper installation of all electrical equipment.

Tip: Because shelf lights are usually recessed, black is the standard paint color. Paint colors other than black have an upcharge.

Tip: If an optional paint color is selected for the housing, the electrical switches and end caps will remain black plastic.

Tip: Flush mounting package contains a pair of clips that allow shelf lights to be installed and removed without tools.

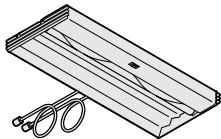
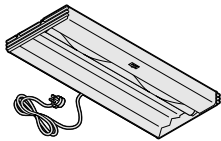

Tip: Remember to order a daisy chain starter cord. ▶ See Related Products on next page.

Standard Includes	Required to Specify
<ul style="list-style-type: none"> Light housing with centered on-off switch: black paint End cap cord managers: black plastic only Cords: <ul style="list-style-type: none"> —9' cord with three-prong plug at 45° angle: black vinyl only —One 30" and one 48" cord with modular connectors for daisy chaining: black vinyl only Contrast sleeve around lamp Faceted reflector: white only T8 3500K lamp Ballast Universal mounting hardware package Daisy chain starter cord, if selected: black vinyl only (order separately) 	<ol style="list-style-type: none"> Style number Paint color number, if other than black (see options below) Options, if selected (see below) <ul style="list-style-type: none"> ▶ See <i>Surface Materials</i>, page C252.

Options	Price	Required to Specify
Surface Materials <ul style="list-style-type: none"> Painted light housing other than black 	+ \$14	Specify paint color number for housing. ▶ See <i>Surface Materials</i> , page C252.
Bracket Options <ul style="list-style-type: none"> Competitive mounting package Flush mounting package 	No cost	Specify with <i>competitive mounting package</i> . Specify with <i>flush mounting package</i> and paint color number for end cap covers.

Specification Information

Dimensions	Lamp	Style	Base
D W H	Wattage	Number	Price

Electronic Ballast

9 1/4"	25"	1 3/4"	17 watts	LSM24K	\$287
9 1/4"	37"	1 3/4"	25 watts	LSM36K	\$308
9 1/4"	49"	1 3/4"	32 watts	LSM48K	\$332

With Chicago Cord Including Circuit Breaker

9 1/4"	25"	1 3/4"	17 watts	LSM24KC	\$334
9 1/4"	37"	1 3/4"	25 watts	LSM36KC	\$355
9 1/4"	49"	1 3/4"	32 watts	LSM48KC	\$379

With Daisy Chain Cords

9 1/4"	25"	1 3/4"	17 watts	LSM24KD	\$311
9 1/4"	37"	1 3/4"	25 watts	LSM36KD	\$332
9 1/4"	49"	1 3/4"	32 watts	LSM48KD	\$356

▶ Specification information continued on next page

► Continued from previous page

Specification Information

• Dimensions			• Lamp	• Style	• Base
D	W	H	Wattage	Number	Price

Economizer Electronic Ballast

9¼"	25"	1¾"	17 watts	LSM24KF	\$326
9¼"	37"	1¾"	25 watts	LSM36KF	\$347
9¼"	49"	1¾"	32 watts	LSM48KF	\$371

With Chicago Cord Including Circuit Breaker

9¼"	25"	1¾"	17 watts	LSM24KFC	\$373
9¼"	37"	1¾"	25 watts	LSM36KFC	\$394
9¼"	49"	1¾"	32 watts	LSM48KFC	\$418

With Daisy Chain Cords

9¼"	25"	1¾"	17 watts	LSM24KFD	\$350
9¼"	37"	1¾"	25 watts	LSM36KFD	\$371
9¼"	49"	1¾"	32 watts	LSM48KFD	\$395

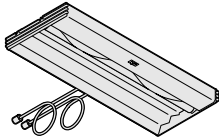
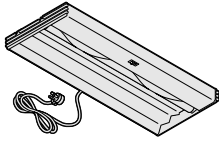

Tip: Remember to order a daisy chain starter cord. ► See Related Products below.



Related Products

• Quantity in Package	• Length	• Style Number	• Base Price
-----------------------	----------	----------------	--------------

Daisy Chain Starter Cord

1	78"	LS1FSC	\$ 40
6	78"	LS6FSC	\$240

Montage

Utility Shelf Lights

SIN 711.1

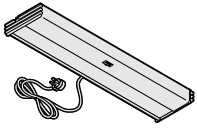

Tip: Daisy chaining is not allowed in New York City or Chicago. Local electrical codes vary, so you should consult a qualified electrical contractor or engineer for proper installation of all electrical equipment.

Tip: Because shelf lights are usually recessed, black is the standard paint color. Paint colors other than black have an upcharge.

Tip: If an optional paint color is selected for the housing, the electrical switches and end caps will remain black plastic.

Tip: Flush mounting package contains a pair of clips that allow shelf lights to be installed and removed without tools.

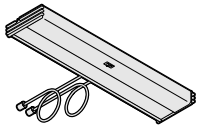
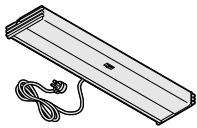

Tip: Remember to order a daisy chain starter cord. ▶ See Related Products on next page.

Standard Includes	Required to Specify
-------------------	---------------------

- Light housing with centered on-off switch: black paint
- End cap cord managers: black plastic only
- Cords:
 - 9' cord with three-prong plug at 45° angle: black vinyl only
 - One 30" and one 48" cord with modular connectors for daisy chaining: black vinyl only
- Prismatic lens
- Angled reflector: white only
- T8 3500K lamp
- Ballast
- Universal mounting hardware package
- Daisy chain starter cord, if selected: black vinyl only (order separately)

- 1 Style number
 - 2 Paint color number, if other than black (see options below)
 - 3 Options, if selected (see below)
- ▶ See *Surface Materials*, page C252.

Options	Price	Required to Specify
---------	-------	---------------------

Surface Materials	<ul style="list-style-type: none"> • Painted light housing other than black 	+\$15 Specify paint color number for housing. ▶ See <i>Surface Materials</i> , page C252.
Lens	<ul style="list-style-type: none"> • Bat-wing lens 	+\$22 Specify with bat-wing lens.
Bracket Options	<ul style="list-style-type: none"> • Competitive mounting package • Flush mounting package 	No cost No cost Specify with competitive mounting package. Specify with flush mounting package and paint color number for end cap covers.

Specification Information

Dimensions	Lamp Wattage	Style Number	Base Price
D W H			

Electronic Ballast

5½"	25"	1¾"	17 watts	LSB24K	\$196
5½"	37"	1¾"	25 watts	LSB36K	\$232
5½"	49"	1¾"	32 watts	LSB48K	\$255

With Chicago Cord Including Circuit Breaker

5½"	25"	1¾"	17 watts	LSB24KC	\$243
5½"	37"	1¾"	25 watts	LSB36KC	\$279
5½"	49"	1¾"	32 watts	LSB48KC	\$302

With Daisy Chain Cords

5½"	25"	1¾"	17 watts	LSB24KD	\$220
5½"	37"	1¾"	25 watts	LSB36KD	\$256
5½"	49"	1¾"	32 watts	LSB48KD	\$279

▶ Specification information continued on next page

► Continued from previous page

Specification Information

• Dimensions			• Lamp Wattage	• Style Number	• Base Price
D	W	H			

Magnetic Normal-Power-Factor Ballast

5½"	19"	1¾"	15 watts	LSB18M	\$158
5½"	25"	1¾"	17 watts	LSB24M	\$139
5½"	37"	1¾"	25 watts	LSB36M	\$175
5½"	49"	1¾"	32 watts	LSB48M	\$198

With Chicago Cord Including Circuit Breaker

5½"	19"	1¾"	15 watts	LSB18MC	\$205
5½"	25"	1¾"	17 watts	LSB24MC	\$186
5½"	37"	1¾"	25 watts	LSB36MC	\$222
5½"	49"	1¾"	32 watts	LSB48MC	\$245

With Daisy Chain Cords

5½"	19"	1¾"	15 watts	LSB18MD	\$182
5½"	25"	1¾"	17 watts	LSB24MD	\$163
5½"	37"	1¾"	25 watts	LSB36MD	\$199
5½"	49"	1¾"	32 watts	LSB48MD	\$222

Related Products

• Quantity in Package	• Length	• Style Number	• Base Price
-----------------------	----------	----------------	--------------

Daisy Chain Starter Cord

1	78"	LS1FSC	\$ 40
6	78"	LS6FSC	\$240

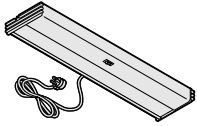

Tip: Magnetic ballasts can cause interference with computer monitors. An electronic ballast is recommended for shelf lights in offices where computers are used.

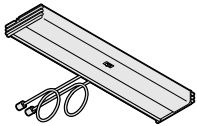

Tip: Remember to order a daisy chain starter cord. ► See Related Products below.

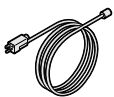

* Because lamps and ballasts for 19"W shelf lights are more expensive than those for 24"W shelf lights, use 19"W shelf lights only in applications where larger sizes will not fit.

Related Products

SIN 711.1

Vertical Wire Managers



Standard Includes	Required to Specify
<ul style="list-style-type: none">Vertical wire manager: 6000 Black plastic or 6659 Light Grey plastic	<ul style="list-style-type: none">1 Style number2 Plastic color number

Specification Information

Height	Style Number	Price
13"	ZWM13	\$10
20"	ZWM20	\$12
:	:	:

Surface Materials

Surface Materials	C252
Wood Matrix	C254
Plastic Color Availability Matrix	C255
Color Coordination Matrix	C256
Specification Guidelines for Vertical Fabric Applications	C258
Wood Grain Directions	C259
How to Care for Laminate, Torus Edge, and Wood Surfaces	C260

Surface Materials

This listing includes all the surface material choices that are available for the products in this specification guide.

Resources

For more information about surface materials, refer to the following resources:

Additional surface materials specification tools are available to assist you in the specification process—the Surface Materials Binders and the Surface Materials Tool Box.

Surface Materials Binders

- Surface Materials Reference Manual
- A complete set of swatch cards for hard surfaces, vertical surface fabrics, and seating upholstery

Surface Materials Tool Box

- (S8150) provides 3" x 3" samples of the following surface materials:
- Vertical surface fabrics
 - Seating upholstery
 - Wood veneer
 - Paint
 - Laminate

Paint

Applies to:

- Frame top caps
- Door frames
- Junctions
- Wall attachment brackets
- Vertical end trim
- Power and cable poles
- Base covers
- Power and data desk-height cavity covers
- Non-tackable tiles
- Slatwall
- Adjustable columns
- Adjustable-height worksurface bases
- End panels
- Pedestals
- Shelves
- Overhead storage bins
- Canopy lights
- Shelf lights
- Waterfall and Rod pulls (paint price group 1 and PerfectMatch II paints only)
- Contemporary pulls (0835 Black only)

Price Group 1

Textured Paint

- 7207 Black
- 7225 Sand (Vanadium)
- 7236 Fog
- 7237 Slate
- 7238 Fieldstone
- 7239 Midnight

Price Group 2

Metallic Paint

- 4750 Champagne
- 4751 Bronze
- 4752 Steel
- 4788 Gold Dust
- 4798 Sterling
- 4799 Platinum

Price Group 3

Accent Paint

Please see the Accent Paint swatch card in the *Surface Materials Finishes Binder* for a complete list of these colorful paints.

PerfectMatch II Paint

PerfectMatch II is a service that allows you to create your own paint color. Refer to the *Surface Materials Reference Manual* for more information about this program.

Laminate

Applies to:

- Doors
 - Worksurfaces
 - Tiles
- 2722 Cream
 - 2729 White Sand
 - 2730 Arctic White
 - 2746 Black
 - 2759 Warm White
 - 2810 Dawn
 - 2811 Mist
 - 2820 Coffee Speckle
 - 2822 Woodrose Speckle
 - 2823 Driftwood Speckle
 - 2824 Smoke Speckle
 - 2825 Vanadium Speckle
 - 2850 Vanadium Fiber
 - 2851 Rhyme Fiber
 - 2852 Tungsten Fiber
 - 2854 Vellum Fiber
 - 2857 Stream Fiber
 - 2859 Novell Fiber
 - 2860 Granite Fiber
 - 2870 Blonde Bronze Patina
 - 2871 Blackened Bronze Patina
 - 2872 Silver Plate Patina
 - 2873 Instant Iron Patina

Woodgrain Laminate

Woodgrain laminates are designed to simulate the appearance of wood and coordinate with select wood finishes. For additional information, refer to the *Surface Materials Reference Manual*.

Applies to:

- Doors
 - Tiles
 - Worksurfaces
- ▶ See page C259 for wood-grain illustrations.

Woodgrain Laminate Choices

- 2412 Natural Cherry
- 2422 Medium Cherry
- 2511 Winter on Maple
- 2592 Blonde on Maple
- 2632 Medium Oak
- 2714 Natural Walnut
- 2772 Medium Mahogany on Walnut

Accent Laminate

Accent laminates are available with an upcharge of \$60 U.S. per worksurface, door, or laminate tile.

Please see the accent laminate swatch card within the *Steelcase Surface Materials Finishes Binder* for a complete listing of these colorful laminates. For additional information, refer to the *Steelcase Surface Materials Reference Manual*.

Open Line Laminate

This service allows you to order non-standard laminate at an additional processing fee upcharge of \$60 per worksurface, door, or laminate tile, plus the cost of the laminate. For additional information, refer to the *Steelcase Surface Materials Reference Manual*.

Wood

Steelcase carefully selects veneer and solid wood or consistent color and grain structure. Wood is a natural material and variations will occur in color, grain and texture. These variations are part of the inherent natural beauty of wood and are not considered defects.

All wood products will darken with age and exposure to ultraviolet light. This is especially apparent with cherry and maple veneer. We recommend that desk accessories be arranged periodically to ensure even aging of wood surfaces.

Veneers are flat cut and are matched for proper balance and consistency.

Open-pore finish is a medium-gloss finish that leaves the wood texture visible to the eye and distinguishable to the touch.

Applies to:

- Montage Wood Selections products
- End trim
- Top caps
- Tiles
- Torus edge tops
- Wood junctions

Open-pore finish choices

- 3412 Natural Cherry
- 3422 Medium Cherry
- 3562 Linseed on Maple
- 3572 Amber Maple on Maple
- 3582 Winter on Maple
- 3592 Blonde on Maple
- 3632 Medium Oak
- 3642 Natural Oak
- 3712 Natural Walnut
- 3722 Dark Mahogany on Walnut
- 3742 Autumn Walnut
- 3772 Medium Mahogany on Walnut
- 3792 Black Walnut

Full-fill finish is a medium-gloss finish that completely fills the grain and has a lustrous, satin look and feel. Full-fill finish is available on wood worksurfaces only.

Full-fill finish choices

- 3414 Natural Cherry
- 3424 Medium Cherry
- 3534 Winter on Maple
- 3544 Blonde on Maple
- 3564 Linseed on Maple
- 3574 Amber on Maple
- 3634 Medium Oak
- 3644 Natural Oak
- 3714 Natural Walnut
- 3724 Dark Mahogany on Walnut
- 3744 Autumn Walnut
- 3774 Medium Mahogany on Walnut
- 3794 Black Walnut

Customiz stain is a service that allows you to create your own stain colors on standard veneers. Customiz stain color is available on all product lines that offer wood veneer.

A one-time formulation fee of \$400 per color, per customer processing fee will apply. The fee covers the cost of formulating the Customiz finish and applies regardless of whether or not an order for product is placed. Please refer to "Customiz Stain" option price guide in your specification guide for the unit upcharge.

Customiz stain takes 10 days to formulate. Consult the *Surface Materials Reference Manual* for more information. Custom veneers are also available and must be quoted by specials engineering. Customiz stain on custom veneers takes 2 to 4 weeks to formulate.

Requirements and information on ordering a Customiz stain color are found in the *Surface Materials Reference Manual*.

Plated Metal

Applies to:

- Waterfall pull and rod
- Montage Wood Selections products

- 9201 Polished Chrome**
- 9210 Copper
- 9211 Nickel
- 9212 Silver
- 9213 Polished Nickel**
- 9230 Antique Bronze**
- 9250 Ember Chrome**

**Not available on Montage steel pedestals

Metal

Applies to:

- Canopy Lights

- 8043 Clear Anodized Aluminum

Plastic

Tip: Plastic and vinyl products may not be available in all colors listed below.

▶ See page C255 for an overview of the plastic colors available for each component.

Applies to:

- Montage Wood Selections products

- 6000 Black
- 6001 Coffee
- 6607 Woodrose
- 6608 Driftwood
- 6612 Grey V2
- 6654 Sand (Vanadium)
- 6655 Warm White
- 6695 Midnight
- 6697 Fog

Applies to:

- Enhanced off-module frame attachment brackets
- Vertical wire managers

- 6000 Black
- 6659 Light Grey

Vertical Surface Fabric

Applies to:

- Non-tackable tiles
- Tackable acoustical tiles
- High-performance tackable acoustical tiles
- Consolidation point locking door tiles

Classics Collection

Surface materials in the Classics Collection are timeless. These materials should be available for a minimum of 10 years from the date the material is introduced into the Classics Collection. The Classics Collection includes the following fabrics in Price Groups 1 through 3:

Price Group 1

- Abacus*
- Acadia*
- Bariolage
- Belgrade
- BellaRose*
- Boccie**
- Cornice*
- Embrasure*
- *Not available on 80"H panels
- **Not available on panels taller than 68"H

Additional fabrics are available in this price group. Call Designtex at 1.800.221.1540 for further information about the Graded-In Program.

Price Group 2

- Amiranté
- Ashanti
- Ashanti Reverse
- Bouquet*
- Cordial
- Firenze
- Firenze Reverse
- Fresco
- Milano
- Racquets**
- Regatta
- Wilshire

*Not available on 80"H panels
**Not available on panels taller than 68"H

Additional fabrics are available in this price group. Call Designtex at 1.800.221.1540 for further information about the Graded-In Program.

Price Group 3

Martinique
▶ See *Surface Materials Reference Manual* for a listing of available fabric colors.

Designtex Graded-In Program

All Designtex Graded-In fabrics are now supported just like standard fabrics when ordered on Steelcase furniture. The Designtex Graded-In Program also includes the Environmental Impact Collection, which offers sustainable textiles in affordable price groups. For additional information and fabric samples, contact your local Designtex sales representative at 1.800.221.1540.

Designtex fabrics are graded into Steelcase Price Groups 1 through 3:

Price Group 1

- Moors (Environmental Impact Collection)

Price Group 2

- About Face
- Acres
- Bracken (Environmental Impact Collection)
- Brunswick
- Cut to the Chase
- Gimlet
- Niche
- Senecal
- Solitaire
- Streams (Environmental Impact Collection)

Price Group 3

- Apex
- Dalmatian
- Foxtrot
- Lotto
- Meringue
- No Deposit No Return
- Pick Up Sticks
- Rain (Environmental Impact Collection)
- Sea Breeze (Environmental Impact Collection)
- Six Pack
- Sumo
- That Straw Stuff

▶ See *Surface Materials Reference Manual* for a listing of available fabric colors.

Price Group COM (Customer's Own Material)

Fabric Approval and Yardage

To confirm whether a particular COM material has already been tested for use on a specific Steelcase product or to determine actual yardage requirements:

- Visit www.steelcase.com
- Click on "Knowledge & Design"
- Select "Customer's Own Material"

You can find the same information on the in2 site. Follow these steps:

- Visit www.in2.steelcase.com
- Click on "Sales/Design Team"
- Select "Surface Materials"
- Select "Customer's Own Material"

For additional information regarding Customer's Own Material, call 1.888.STEELCASE.

Transitional

▶ See the *Transitional Specification Guide* for a list of transitional surface materials.

Wood Matrix

	Fill Level	Availability	Montage End Trims	Montage Top Caps	Montage Wood Junction Kits	Montage Tiles	Montage Torus Edge Worksurfaces	Montage Wood Selections
3412 Natural Cherry	OP	■	■	■	■	■	■	■
3414 Natural Cherry	FF	□					■	■
3422 Medium Cherry	OP	■	■	■	■	■	■	■
3424 Medium Cherry	FF	□					■	■
3534 Winter on Maple	FF	□					■	■
3544 Blonde on Maple	FF	□					■	■
3562 Linseed on Maple	OP	■	■	■	■	■	■	■
3564 Linseed on Maple	FF	□					■	■
3572 Amber on Maple	OP	■	■	■	■	■	■	■
3574 Amber on Maple	FF	□					■	■
3582 Winter on Maple	OP	■	■	■	■	■	■	■
3592 Blonde on Maple	OP	■	■	■	■	■	■	■
3632 Medium Oak	OP	■	■	■	■	■	■	■
3634 Medium Oak	FF	□					■	■
3642 Natural Oak	OP	■	■	■	■	■	■	■
3644 Natural Oak	FF	□					■	■
3712 Natural Walnut	OP	■	■	■	■	■	■	■
3714 Natural Walnut	FF	□					■	■
3722 Dark Mahogany on Walnut	OP	■	■	■	■	■	■	■
3724 Dark Mahogany on Walnut	FF	□					■	■
3742 Autumn Walnut	OP	■	■	■	■	■	■	■
3744 Autumn Walnut	FF	□					■	■
3772 Medium Mahogany on Walnut	OP	■	■	■	■	■	■	■
3774 Medium Mahogany on Walnut	FF	□					■	■
3792 Black Walnut	OP	■	■	■	■	■	■	■
3794 Black Walnut	FF	□					■	■

Legend

- = Available
- = Available with exceptions
- OP= Open-pore
- FF = Full-fill

Plastic Color Availability Matrix

Available on Wood Selections Products Only

Not every plastic component is available in every plastic color. This matrix gives you an overview of which plastic colors can be specified for each Wood Selections plastic component.

	6000 Black	6001 Coffee	6607 Woodrose	6608 Driftwood	6612 Grey V2	6654 Sand (Vanadium)	6655 Warm White	6695 Midnight	6697 Fog
--	------------	-------------	---------------	----------------	--------------	----------------------	-----------------	---------------	----------

Worksurfaces

3-piece grommets	■	■	■	■	■	■	•	■	■
4" square grommet	■	•	•	•	•	•	•	•	•
Channel grommet	■	•	•	•	•	•	•	•	•
Grommet convenience receptacle	■	•	•	•	•	•	■	•	•

Available on Internode Products Only

Not every plastic component is available in every plastic color. This matrix gives you an overview of which plastic colors can be specified for each Internode plastic component.

	6000 Black	6651 Tungsten	6652 Titanium	6653 Solar Black	6654 Vanadium	6656 Tantalum	6681 Grotto
Internode mounting bracket	•	•	•	■	•	•	•
Internode power module covers	•	•	•	■	•	•	•
Internode convenience tri-receptacles	■	■	■	■	■	■	■
Internode convenience communication outlet housing	■	■	■	■	■	■	■
Internode above-worksurface clamp kit	•	•	•	■	•	•	•
Internode multipurposepower infeed cover	■	■	■	■	■	■	■
Internode beltway power outfeed	■	■	■	■	■	■	■
Internode receptacles	■	■	■	■	■	■	■
Internode cord and cable manager	•	•	•	■	•	•	•
Consolidation point cabinet cable pole	■	■	■	■	■	■	■

Legend

- = Not available
- = Available

Color Coordination Matrix

Laminate

PVC and Torus Edges

The PVC and torus edge colors are determined by the laminate color and therefore cannot be specified.

Laminate Color Selections	Default Color of PVC Edge	Default Color of Torus Edge
2714 Natural Walnut	2714 Natural Walnut	6001 Coffee
2722 Cream	2722 Cream	6631 Cream
2729 White Sand	2848 Sand (Vanadium)	6654 Sand (Vanadium)
2730 Designer White	2776 Fog	6697 Fog
2746 Black	2792 Black	6000 Black
2759 Warm White	2759 Viola	6655 Warm White
2772 Medium Mahogany on Walnut	2772 Medium Mahogany on Walnut	6001 Coffee
2810 Dawn	2794 Dawn	6635 Dawn
2811 Mist	2798 Mist	6636 Mist
2820 Coffee Speckle	2722 Cream	6001 Coffee
2822 Woodrose Speckle	2794 Dawn	6635 Dawn
2823 Driftwood Speckle	2722 Cream	6631 Cream
2824 Smoke Speckle	2798 Mist	6636 Mist
2825 Vanadium Speckle	2720 Ice	6612 Grey V2
2837 Woodrose Pattern	2794 Dawn	6635 Dawn
2839 Driftwood Pattern	2722 Cream	6631 Cream
2841 Smoke Pattern	2798 Mist	6636 Mist
2850 Vanadium Fiber	2848 Sand (Vanadium)	6654 Sand (Vanadium)
2851 Rhyme Fiber	2722 Cream	6631 Cream
2852 Tungsten Fiber	2798 Mist	6636 Mist
2854 Vellum Fiber	2759 Warm White	6655 Warm White
2857 Stream Fiber	2798 Mist	6636 Mist
2859 Novell	2793 Coffee	6001 Coffee
2860 Granite	2792 Black	6000 Black
2870 Blonde Bronze Patina	2848 Sand (Vanadium)	6654 Sand (Vanadium)
2871 Blackened Bronze Patina	2785 Grey V5	6615 Grey V5
2872 Silver Plate Patina	2720 Ice	6612 Grey V2
2873 Instant Iron Patina	2785 Grey V5	6615 Grey V5

Torus Edge Detail

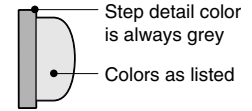

Exception: Solids

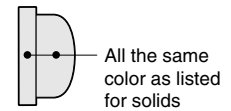

Woodgrain Laminate

PVC and Torus Edges

The PVC and torus edge colors are determined by the laminate color and therefore cannot be specified.

Laminate Color Selections	Default Color of PVC Edge	Default Color of Torus Edge
2412 Natural Cherry	2412 Natural Cherry	6S01 Coffee Solid
2422 Medium Cherry	2422 Medium Cherry	6S01 Coffee Solid
2511 Winter on Maple	2511 Winter on Maple	6S59 Warm White Solid
2592 Blonde on Maple	2592 Blonde on Maple	6S59 Warm White Solid
2632 Medium Oak	2632 Medium Oak	6S01 Coffee Solid

Torus Edge Detail

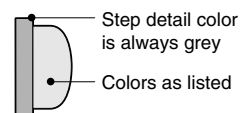

Exception: Solids

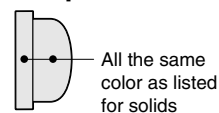

Specification Guidelines for Vertical Fabric Applications

Standard warp direction on all Montage tiles is warp horizontal.

Fabric-covered tiles ordered before October 16, 1995,

were fabricated with warp horizontal or warp vertical depending on the fabric. Now all tiles will be warp horizontal.

Tip: If you're ordering tiles to match those in an existing installation, you may want to specify the fabric with warp vertical.

▶ See table at right.

Steelcase is not responsible for charges associated with replacement or reupholstery of tile surfaces due to incorrect specifications.

Application Topics

Surface materials consultants are available to answer your questions and to provide clarification about COM availability, testing, yardage requirements, etc. Call 616.246.9822.

For flammability ratings, see *Flammability Ratings for Steelcase Panel Systems*, page A16.

Price

No additional cost to specify warp direction.

How to Specify

You must specify warp direction when you need to depart from the standard. Fabric direction on Montage tiles can be specified electronically. On non-electronic orders, add a written specification to each tile to indicate non-standard warp directions.

Warp Directions for Montage Tiles

Fabric		Before October 16, 1995	October 16, 1995 and After
Abacus	D	N.A.	H
Acadia	D	N.A.	H
Amiranté	D	V	H
Ashanti	D	V	H
Ashanti Reverse	D	V	H
Bariolage	D	N.A.	H
Belgrade	D	N.A.	H
BellaRose	D	N.A.	H
Bouquet	D	N.A.	H
Cordial	D	V	H
Cornice	D	N.A.	H
Embrasure	D	N.A.	H
Firenze	D	H	H
Firenze Reverse	D	H	H
Fresco	D	H	H
Martinique	D	V	H
Milano	D	H	H
Racquets	D	N.A.	H
Regatta	ND	H	H
Wilshire	D	H	H

D = Directional
 ND = Non-directional
 H = Wrap Horizontal
 V = Wrap Vertical

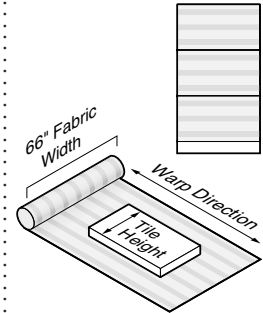

Warp horizontal means the height dimension of the tile is perpendicular to the warp of the fabric.

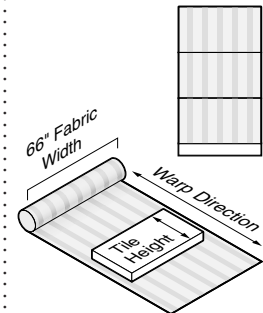

Warp vertical means the height dimension of the tile is parallel to the warp of the fabric.

Wood Grain Directions











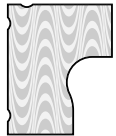
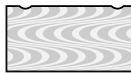

Montage

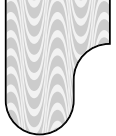
Directional laminates are standard with the grain directions shown.

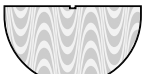
*Adjustable-height worksurfaces not available in wood veneer.

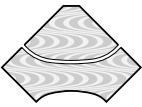
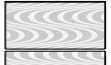
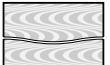
**Grain direction will run parallel to the longest edge.

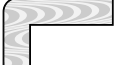
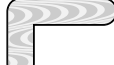





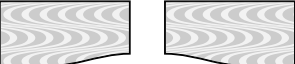
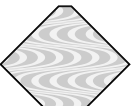

Torus Edge Worksurfaces

					
Corner Worksurface	Extended Corner Worksurface	Extended Corner Cove Worksurface	Straight Worksurface	Bubble Visitor Worksurface	Jetty Worksurface
					
Bubble Jetty Worksurface	Spanner Worksurface	Straight Countertop	Adjustable-Height Dual Corner Worksurface*	Adjustable-Height Bi-Level Corner Worksurface*	Adjustable-Height Dual Straight Worksurface*
					
Adjustable-Height Bi-Level Straight Worksurface*	Corner Countertop One Straight End One Round End (Laminate)**	Corner Countertop One Straight End One Round End (Wood Veneer)**	Corner Countertop Both Ends Straight**	Corner Countertop Both Ends Round**	Corner Countertop Round or Straight Ends, Equal Dimensions

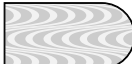
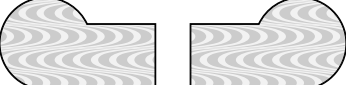
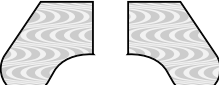
Natural wood veneers do not have mitered corner surfaces.

The appearance of wood veneer may change slightly depending on the angle from which it is viewed. This natural phenomenon is called polarization, and it can be seen on natural veneer. Polarization is often noticed on worksurfaces installed at a 90-degree angle with each other. Please refer to the following illustrations for an understanding of grain direction on your installation.

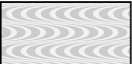
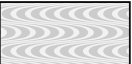
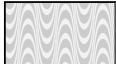
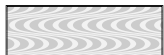
Wood Selections Worksurfaces

				
Straight Worksurface	Transition Worksurface			
				
Corner Worksurface	Cornerstone Worksurface	Bullet Top Worksurface	P-Top Worksurface	
				
Sock Top Worksurface	Scoop Top Worksurface	Curved-Front Transaction Worksurface	Tether Table	
				
Freestanding Desk Shell	Return Shell	Bridge Shell	Credenza Shell	Spanner Worksurface

Tiles

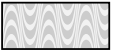
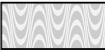
	
Laminate	Natural Veneer

Doors

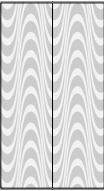
	
Laminate	Laminate

How to Care for Laminate, Torus Edge, and Wood Surfaces

Laminate

Cleaning

Wiping with a damp cloth will remove general soiling and water-borne stains. If needed, use a hard-surface, all-purpose cleaner such as Formula 409, Fantastik, Top Job, Mr. Clean, etc. Some oil-borne stains may require the use of a dry-cleaning fluid. To fill scratches in wood grain laminate tops, use an oak, walnut, or mahogany putty stick (available at paint supply and hardware stores).

Torus Edge

Cleaning

Wiping with a damp cloth will remove general soiling and water-borne stains. If needed, use a hard-surface, all-purpose cleaner such as Formula 409, Fantastik, Top Job, Mr. Clean, etc. Some oil-borne stains may require the use of a dry-cleaning fluid.

Wood

Protection

Use desk pads and coasters to help protect the finish against dents, scratches, moisture and hot and cold liquids. Do not use desk pads that have plastic backing.

Use felt or leather pads on the bottoms of office equipment and accessories.

Lift objects when you move them, instead of pulling or pushing them across the surface, to avoid scratching the surface.

Periodically move desk accessories and other objects kept on the work-surface to ensure even aging.

Avoid leaving vinyl binders on work-surface for long periods.

If you use a protective glass top, insert felt pads between the glass and the work-surface, to create an air space and allow the wood to breathe.

Keep your furniture away from direct sunlight.

Avoid extreme temperatures and humidity. Maintain temperatures between 60 and 80 degrees Fahrenheit and humidity levels between 30 and 50 percent.

Cleaning

Keep a supply of soft, clean, absorbent cloths handy for wiping up spills and regular dusting.

Dusting
Clean with a slightly damp, soft cloth, using another soft cloth to dry. Always wipe the surface in the direction of the wood grain.

Cleaning
Use a quality cleaner or flax soap formulated especially for use on wood surfaces. Do not use oils or ammonia. Dilute the cleaner as directed by the manufacturer. Dampen but do not saturate a soft cloth with the diluted cleaning solution. Wipe the surface in the direction of the wood grain to remove dirt and fingerprints. Wipe the surface clean with a soft, dry cloth.

Waxing
Quality spray wax may be applied sparingly twice a year. Excessive waxing may result in a wax build-up which feels sticky and attracts an unusual amount of dirt. For information about how to remove this wax, contact your facilities department or Steelcase dealer.

Hardware
Clean metal finishes with a non-abrasive cleaner. Apply the cleaner sparingly, making sure that it does not come into contact with the wood. Wipe the hardware dry with a clean, soft cloth.

Help with Repair and Maintenance
Wood is a "forgiving" material which usually can be repaired. If your work-surface is damaged, call your facilities department or Steelcase dealer.

Many Steelcase dealers offer maintenance contracts for your convenience. Contact your dealer for more information.

Resources

Resources

Montage

Lock and Keying

C262

Montage

Lock and Keying

All locking products are standard with factory-installed, keyed-random locks. Consecutive, specific, and random keying are available as field-installed options.

Exceptions: Individual locking drawers are available only with field-installed

locks. 900 Series overfiles are available only with factory-installed locks.

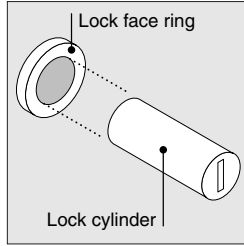

Locks consist of a factory- or field-installed lock cylinder and a factory-installed lock face ring.

Two types of locks are available—the standard keying system (FR series) and the master keying system (XF series). All the locks in the XF series can be opened with a single master key.

Factory-Installed Keying

Factory-installed locks are always key random (standard) or master key random (option). Key random means that the locks will be assigned arbitrarily at the factory with key numbers ranging from FR305 to FR454 (Master keying numbers: XF1001 to XF1150). All locks within a unit will be keyed alike.

Tip: Random keying can mean that different furniture

units will have the same key number. If you must have all locks keyed differently, you should specify field-installed, key specific or key consecutive lock cylinders.
▶ See below.

Key Random

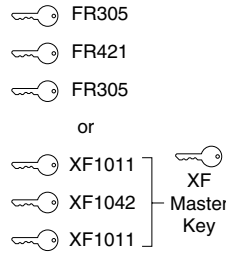

Required to Specify

	Master key	+\$20	Specify with master key
	random		random.

Field-Installed Keying

Field-installed locks are only available on products that include factory-installed lock mechanisms.
Exception: 900 Series overfiles are available only with factory-installed locks.

Specify "plug" when specifying furniture, and the product will ship with a plastic plug in place of the lock cylinder.

Front-removable lock cylinders must be specified separately. You must also order a special lock tool to install or remove lock cylinders in the field.
Tip: Lock tools are reusable. You do not need to order additional lock tools with every furniture order.

Lock cylinders will be shipped separately so that you can install the locks when you are ready.

Three keying choices are available for field installation—random (standard), specific, and consecutive. All three are also available with master keying, which means that all locks can be opened with a single master key.

Key random means that the locks will be assigned arbitrarily at the factory with key numbers ranging from FR305 to FR454 (Master keying numbers: XF1001 to XF1150).
Tip: Random keying can mean that different furniture units will have the same key number. If you must have all locks keyed differently, you should specify key specific or key consecutive lock cylinders.

Key specific means that you can specify any key number from FR305 to FR454 (Master keying numbers: XF1001 to XF1150). This option can be used to key all the furniture units in a workstation or department the same.
Tip: Designate the quantity per key number in your specification.
▶ See example at right.

Key consecutive means that you can specify lock numbers in a consecutive order to ensure that no two locks have the same key number until the key sequence repeats. You must select a beginning key number from FR305 to FR454 (Master keying numbers: XF1001 to XF1150).

Example of a typical lock cylinder specification is shown below:

10	LOCK9201FR FR320
5	LOCK9201FR FR350
15	LOCK9201XF XF1100
30	Total
1	877102003SR standard lock tool
1	877102002SR master lock tool

Key Random

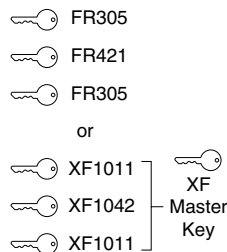

Key Specific

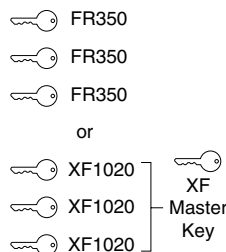

Key Consecutive

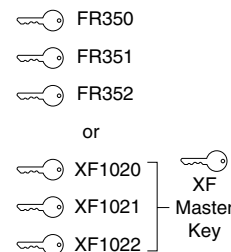

Field-Installed Lock Cylinders

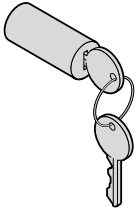

Tip: Lock price is included in price of furniture with locks.

Tip: For replacement lock cylinders, refer to Service Parts.

Standard Includes	Required to Specify
-------------------	---------------------

- | | |
|--|--|
| <ul style="list-style-type: none"> Lock cylinder, keyed random: 9201 Polished Chrome, 9250 Ember Chrome Two keys | <ul style="list-style-type: none"> 1 Style number 2 Options, if selected (see below) |
|--|--|

Options	Price	Required to Specify
---------	-------	---------------------

Key specific	No cost	Select key number from FR305–FR454.
Key consecutive	No cost	Specify <i>key consecutive</i> and must select beginning key number from FR305–FR454.
Master key random	+\$20 each	Specify <i>master key random</i> .
Master key specific	+\$20 each	Specify key number from XF1001–XF1150.
Master key consecutive	+\$20 each	Specify <i>master key consecutive</i> and must select beginning key number from XF1001–XF1150.

Specification Information

Color	Style Number	Base Price
-------	--------------	------------

FR Series (Standard Keying System) – Lock Cylinder

Polished Chrome	LOCK9201FR	No cost
Ember Chrome	LOCK9250FR	No cost

Standard Lock Tool

	877102003SR	\$16
--	--------------------	------

XF Series (Master Keying System) – Lock Cylinder

Polished Chrome	LOCK9201XF	No additional cost. Price included in price of furniture with master-keyed locks.
Ember Chrome	LOCK9250XF	No additional cost. Price included in price of furniture with master-keyed locks.

Master Lock Tool

	877102002SR	\$16
--	--------------------	------

Tip: You can change lock cylinders in the field by using the appropriate lock tool.



Specifying Systems Worksurfaces

Worksurfaces

Straight Worksurfaces (SIN 711.1)	D2
Transition Worksurfaces (SIN 711.1)	D4
Corner, Straight-Front Worksurfaces (SIN 711.1)	D6
Corner, Straight-Front Worksurfaces with Adjustable Keyboard Shelf (SIN 711.1)	D7
Corner, Curved-Front Worksurfaces (SIN 711.1)	D8
Extended Corner, Straight-Front Worksurfaces (SIN 711.1)	D10
Extended Corner, Straight-Front Worksurfaces with Adjustable Keyboard Shelf (SIN 711.1)	D12
Extended Corner, Curved-Front Worksurfaces (SIN 711.1)	D14
Corner, 120° Worksurfaces (SIN 711.1)	D16
Corner, 120° Worksurfaces with Adjustable Keyboard Shelf (SIN 711.1)	D17
Spanner Worksurfaces (SIN 711.1)	D18
Bullet Peninsula, Straight-Front Worksurfaces (SIN 711.1)	D19
Bullet Peninsula, Curved-Front Worksurfaces (SIN 711.1)	D20
Angled Peninsula, Straight-Front Worksurfaces (SIN 711.1)	D21
Angled Peninsula, Curved-Front Worksurfaces (SIN 711.1)	D22
Jetty, Straight-Front Worksurfaces (SIN 711.1)	D23
Jetty, Curved-Front Worksurfaces (SIN 711.1)	D24
Bubble Jetty Worksurfaces (SIN 711.1)	D25
Visitor and Linking, Straight-Front Worksurfaces (SIN 711.1)	D26
Visitor and Linking, Curved-Front Worksurfaces (SIN 711.1)	D28
Transaction Worksurfaces (SIN 711.1)	D30
Adjustable-Height Worksurfaces (SIN 711.1)	D32

Panel-Mounted Worksurface Supports **D38**

Legs and Supports for Universal Systems Worksurfaces **D45**

Straight Worksurfaces

Laminate or Wood Veneer

SIN 711.1

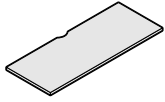

Tip: Supports for freestanding and panel-mounted applications must be specified separately.

Tip: Reinforcing channel (TS7WKSPT) is recommended to add support to worksurfaces that have 60" or more of unsupported knee-space. Must be specified separately.
▶ Page D40

Standard Includes		Required to Specify	
<ul style="list-style-type: none"> • Worksurface: laminate or wood veneer • Laminate worksurface: <ul style="list-style-type: none"> –Vinyl 3 mm edge profile or plastic P-edge profile on front edge –Plastic default flat profile on side and back edges • Wood worksurface: <ul style="list-style-type: none"> –Wood 3 mm edge profile on front edge –Matching veneer flat profile on side and back edges • Cable scallop on back edge 		<ol style="list-style-type: none"> 1 Style number with appropriate edge profile suffix in the space provided <ul style="list-style-type: none"> P Laminate with vinyl P-edge SW Wood with square edge ▶ See edge profiles at right 2 Laminate or wood color number for worksurface 3 Plastic color number for front edge on laminate worksurface, if selected 4 Options, if selected (see below) <ul style="list-style-type: none"> ▶ See <i>Surface Materials</i>, page D102. 	
Options		Price	Required to Specify
Surface Materials	Laminate worksurfaces		
	<ul style="list-style-type: none"> • Accent laminate • Open Line laminate 	+\$60 +\$60 plus cost of laminate	<ul style="list-style-type: none"> ▶ See <i>Surface Materials Reference Manual</i>. ▶ See <i>Surface Materials Reference Manual</i>.
	Wood veneer worksurfaces		
	<ul style="list-style-type: none"> • Customiz stain • Full-fill finish 	Prices at right Prices at right	<ul style="list-style-type: none"> Specify with <i>Customiz stain</i>. ▶ See <i>Surface Materials Reference Manual</i>. Specify full-fill finish number.
Scallops	<ul style="list-style-type: none"> • Omit scallop 	No cost	Specify <i>omit scallop</i> .
Related Products	<ul style="list-style-type: none"> • Panel-mounted Universal Systems worksurface supports • Legs and supports for Universal Systems Worksurfaces • Reinforcing channel • Worksurface screens • Worksurface power and communication components 		<ul style="list-style-type: none"> ▶ Page D38 ▶ Page D45 ▶ Page D40 ▶ Page D77 ▶ Page D81

SIN 711.1

Tip: To specify 3 mm edge profile, no suffix is required. For all other edge profiles, add a suffix to the style number (for example, US1830 becomes US1830SW for wood with square edge profile).

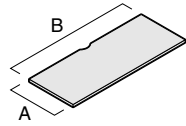

Specification Information

Planning Dimensions A B		Style Number	Base Prices		Wood		Options (Add \$ to Base Price) Customiz : Full-Fill Stain on : Finish Wood : Wood	
			Laminate		Wood Square Edge			
			Vinyl 3 mm Edge No Suffix	Vinyl P-Edge Suffix P	Wood Square Edge Suffix SW			
18"	30"	US1830__	\$155	\$215	\$365	+\$32	+\$32	
18"	36"	US1836__	\$165	\$225	\$375	+\$33	+\$33	
18"	42"	US1842__	\$180	\$250	\$420	+\$37	+\$37	
18"	48"	US1848__	\$215	\$285	\$455	+\$38	+\$38	
18"	54"	US1854__	\$232	\$302	\$472	+\$40	+\$40	
18"	60"	US1860__	\$249	\$329	\$519	+\$43	+\$43	
24"	24"	US2424__	\$159	\$219	\$369	+\$32	+\$32	
24"	30"	US2430__	\$170	\$230	\$380	+\$32	+\$32	
24"	36"	US2436__	\$180	\$240	\$390	+\$33	+\$33	
24"	42"	US2442__	\$195	\$265	\$435	+\$37	+\$37	
24"	48"	US2448__	\$230	\$300	\$470	+\$38	+\$38	
24"	54"	US2454__	\$247	\$317	\$487	+\$40	+\$40	
24"	60"	US2460__	\$264	\$344	\$534	+\$43	+\$43	
24"	66"	US2466__	\$294	\$374	\$564	+\$44	+\$44	
24"	72"	US2472__	\$329	\$409	\$599	+\$46	+\$46	
30"	24"	US3024__	\$225	\$285	\$435	+\$32	+\$32	
30"	30"	US3030__	\$234	\$294	\$444	+\$33	+\$33	
30"	36"	US3036__	\$249	\$309	\$459	+\$35	+\$35	
30"	42"	US3042__	\$264	\$334	\$504	+\$38	+\$38	
30"	48"	US3048__	\$299	\$369	\$539	+\$40	+\$40	
30"	54"	US3054__	\$319	\$389	\$559	+\$41	+\$41	
30"	60"	US3060__	\$339	\$419	\$609	+\$44	+\$44	
30"	66"	US3066__	\$369	\$449	\$639	+\$46	+\$46	
30"	72"	US3072__	\$403	\$483	\$673	+\$47	+\$47	
:	:	:	:	:	:	:	:	

Worksurfaces

Transition Worksurfaces

Laminate or Wood Veneer

SIN 711.1

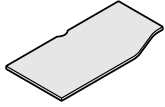

Tip: Illustration above shows a left-hand worksurface.

Tip: Supports for freestanding and panel-mounted applications must be specified separately.

Standard Includes	Required to Specify
<ul style="list-style-type: none"> • Worksurface: laminate or wood veneer • Laminate worksurface: <ul style="list-style-type: none"> –Vinyl 3 mm edge profile or plastic P-edge profile on front edge –Plastic default flat profile on side and back edges • Wood worksurface: <ul style="list-style-type: none"> –Wood 3 mm edge profile on front edge –Matching veneer flat profile on side and back edges • Cable scallop on back edge 	<ol style="list-style-type: none"> 1 Style number with appropriate edge profile suffix in the space provided <ul style="list-style-type: none"> P Laminate with vinyl P-edge SW Wood with square edge <ul style="list-style-type: none"> ▶ See edge profiles at right 2 Laminate or wood color number for worksurface 3 Plastic color number for front edge on laminate worksurface, if selected 4 Options, if selected (see below) <ul style="list-style-type: none"> ▶ See <i>Surface Materials</i>, page D102.

Options	Price	Required to Specify
Surface Materials	Laminate worksurfaces	
	<ul style="list-style-type: none"> • Accent laminate +\$60 • Open Line laminate +\$60 plus cost of laminate	<ul style="list-style-type: none"> ▶ See <i>Surface Materials Reference Manual</i>. ▶ See <i>Surface Materials Reference Manual</i>.
	Wood veneer worksurfaces	
	<ul style="list-style-type: none"> • Customiz stain Prices at right • Full-fill finish Prices at right 	<ul style="list-style-type: none"> Specify with <i>Customiz stain</i>. ▶ See <i>Surface Materials Reference Manual</i>. Specify full-fill finish number.
Scallops	<ul style="list-style-type: none"> • Omit scallop No cost 	Specify <i>omit scallop</i> .
Related Products	<ul style="list-style-type: none"> • Panel-mounted Universal Systems worksurface supports • Legs and supports for Universal Systems Worksurfaces • Worksurface screens • Worksurface power and communication components 	<ul style="list-style-type: none"> ▶ Page D38 ▶ Page D45 ▶ Page D77 ▶ Page D81

Tip: To specify 3 mm edge profile, no suffix is required. For all other edge profiles, add a suffix to the style number (for example, US1830_ becomes US1830SW for wood with square edge profile).

Specification Information

• Planning Dimensions A B C	• Style Number	• Base Prices		• Wood Square Edge Suffix SW	• Options (Add \$ to Base Price) Customiz : Full-Fill Stain on : Finish Wood
		• Vinyl 3 mm Edge No Suffix	• Vinyl P-Edge Suffix P		

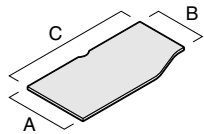

Left-Hand Worksurfaces

24"	18"	36"	UT2136L_	\$299	\$359	\$569	+\$33	+\$33
24"	18"	42"	UT2142L_	\$315	\$385	\$585	+\$37	+\$37
24"	18"	48"	UT2148L_	\$367	\$437	\$637	+\$38	+\$38
24"	18"	54"	UT2154L_	\$393	\$463	\$663	+\$40	+\$40
24"	18"	60"	UT2160L_	\$419	\$499	\$689	+\$43	+\$43
30"	24"	36"	UT3236L_	\$352	\$412	\$622	+\$37	+\$37
30"	24"	42"	UT3242L_	\$370	\$440	\$640	+\$38	+\$38
30"	24"	48"	UT3248L_	\$432	\$502	\$702	+\$40	+\$40
30"	24"	54"	UT3254L_	\$462	\$532	\$732	+\$43	+\$43
30"	24"	60"	UT3260L_	\$493	\$573	\$763	+\$47	+\$47

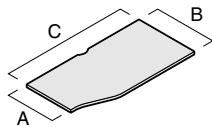

Right-Hand Worksurfaces

18"	24"	36"	UT1236R_	\$299	\$359	\$569	+\$33	+\$33
18"	24"	42"	UT1242R_	\$315	\$385	\$585	+\$37	+\$37
18"	24"	48"	UT1248R_	\$367	\$437	\$637	+\$38	+\$38
18"	24"	54"	UT1254R_	\$393	\$463	\$663	+\$40	+\$40
18"	24"	60"	UT1260R_	\$419	\$499	\$689	+\$43	+\$43
24"	30"	36"	UT2336R_	\$352	\$412	\$622	+\$37	+\$37
24"	30"	42"	UT2342R_	\$370	\$440	\$640	+\$38	+\$38
24"	30"	48"	UT2348R_	\$432	\$502	\$702	+\$40	+\$40
24"	30"	54"	UT2354R_	\$462	\$532	\$732	+\$43	+\$43
24"	30"	60"	UT2360R_	\$493	\$573	\$763	+\$47	+\$47

Worksurfaces

Corner, Straight-Front Worksurfaces

Laminate or Wood Veneer

SIN 711.1



Tip: Supports must be specified separately, including side support brackets for rear corner support in panel-mounted applications.

Standard Includes	Required to Specify
<ul style="list-style-type: none"> • Worksurface: laminate or wood veneer • Laminate worksurface: <ul style="list-style-type: none"> –Vinyl 3 mm edge profile or plastic P-edge profile on front edge –Plastic default flat profile on side and back edges • Wood worksurface: <ul style="list-style-type: none"> –Wood 3 mm edge profile on front edge –Matching veneer flat profile on side and back edges • Cable scallops on back edges 	<ol style="list-style-type: none"> 1 Style number with appropriate edge profile suffix in the space provided <ul style="list-style-type: none"> P Laminate with vinyl P-edge SW Wood with square edge ▶ See edge profiles below 2 Laminate or wood color number for worksurface 3 Plastic color number for front edge on laminate worksurface, if selected 4 Options, if selected (see below) <ul style="list-style-type: none"> ▶ See <i>Surface Materials</i>, page D102.

Options	Price	Required to Specify
Surface Materials <ul style="list-style-type: none"> • Laminate worksurfaces <ul style="list-style-type: none"> • Accent laminate +\$60 • Open Line laminate +\$60 plus cost of laminate • Wood veneer worksurfaces <ul style="list-style-type: none"> • Customiz stain Prices below • Full-fill finish Prices below 		<ul style="list-style-type: none"> ▶ See <i>Surface Materials Reference Manual</i>. ▶ See <i>Surface Materials Reference Manual</i>. Specify with <i>Customiz stain</i>. ▶ See <i>Surface Materials Reference Manual</i>. Specify full-fill finish number.
Scallops <ul style="list-style-type: none"> • Omit scallops 	No cost	Specify <i>omit scallops</i> .
Related Products <ul style="list-style-type: none"> • Panel-mounted Universal Systems worksurface supports • Legs and supports for Universal Systems Worksurfaces • Worksurface screens • Worksurface power and communication components 		<ul style="list-style-type: none"> ▶ Page D38 ▶ Page D45 ▶ Page D77 ▶ Page D81

Tip: To specify 3 mm edge profile, no suffix is required. For all other edge profiles, add a suffix to the style number (for example, US1830_ becomes US1830SW for wood with square edge profile).

Specification Information

Planning Dimensions A B C D				Style Number	Base Prices			Options (Add \$ to Base Price) Customiz Stain on Wood : Full-Fill Finish	
					Vinyl 3 mm Edge No Suffix	Vinyl P-Edge Suffix P	Wood Square Edge Suffix SW		
18"	18"	42"	42"	UC114242 _	\$331	\$421	\$556	+\$48	+\$48
18"	24"	42"	42"	UC124242 _	\$360	\$450	\$585	+\$48	+\$48
24"	18"	42"	42"	UC214242 _	\$360	\$450	\$585	+\$48	+\$48
24"	24"	36"	36"	UC223636 _	\$343	\$423	\$568	+\$48	+\$48
24"	24"	42"	42"	UC224242 _	\$375	\$465	\$600	+\$48	+\$48
24"	24"	48"	48"	UC224848 _	\$420	\$510	\$645	+\$50	+\$50
24"	24"	60"	60"	UC226060 _	\$724	\$824	N.A.	N.A.	N.A.
30"	30"	42"	42"	UC334242 _	\$411	\$501	\$636	+\$49	+\$49
30"	30"	48"	48"	UC334848 _	\$459	\$549	\$684	+\$52	+\$52

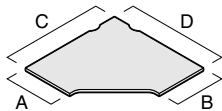

Corner, Straight-Front Worksurfaces with Adjustable Keyboard Shelf

Laminate or Wood Veneer

Corner, Straight-Front Worksurfaces with Adjustable Keyboard Shelf

SIN 711.1



Tip: Supports must be specified separately, including side support brackets for rear corner support in panel-mounted applications.

Tip: Keyboard mechanism requires field attachment to the worksurface and keyboard shelf.

Standard Includes Required to Specify

- | | |
|--|--|
| <ul style="list-style-type: none"> • Worksurface: laminate or wood veneer • Laminate worksurface: <ul style="list-style-type: none"> -Vinyl 3 mm edge profile or plastic P-edge profile on front edge -Plastic default flat profile on side and back edges -Vinyl 3 mm edge profile or plastic P-edge profile on all edges of keyboard shelf • Wood worksurface: <ul style="list-style-type: none"> -Wood 3 mm edge profile on front edge -Matching veneer flat profile on side and back edges -Wood 3 mm edge profile on all edges of keyboard shelf • Cable scallops on back edges • Keyboard mechanism | <ol style="list-style-type: none"> 1 Style number with appropriate edge profile suffix in the space provided <ul style="list-style-type: none"> P Laminate with vinyl P-edge SW Wood with square edge ▶ See edge profiles below 2 Laminate or wood color number for worksurface 3 Plastic color number for edges on laminate worksurface, if selected 4 Options, if selected (see below) <ul style="list-style-type: none"> ▶ See <i>Surface Materials</i>, page D102. |
|--|--|

Options Price Required to Specify

Surface Materials	Laminate worksurfaces <ul style="list-style-type: none"> • Accent laminate +\$60 • Open Line laminate +\$60 plus cost of laminate <hr/> Wood veneer worksurfaces <ul style="list-style-type: none"> • Customiz stain Prices below • Full-fill finish Prices below 	<ul style="list-style-type: none"> ▶ See <i>Surface Materials Reference Manual</i>. ▶ See <i>Surface Materials Reference Manual</i>. <hr/> <ul style="list-style-type: none"> Specify with <i>Customiz stain</i>. ▶ See <i>Surface Materials Reference Manual</i>. Specify full-fill finish number.
Scallops	<ul style="list-style-type: none"> • Omit scallops No cost 	Specify <i>omit scallops</i> .
Related Products	<ul style="list-style-type: none"> • Panel-mounted Universal Systems worksurface supports • Legs and supports for Universal Systems Worksurfaces • Worksurface screens • Worksurface power and communication components 	<ul style="list-style-type: none"> ▶ Page D38 ▶ Page D45 ▶ Page D77 ▶ Page D81

Tip: To specify 3 mm edge profile, no suffix is required. For all other edge profiles, add a suffix to the style number (for example, US1830__ becomes US1830SW for wood with square edge profile).

Specification Information

Planning Dimensions A B C D				Style Number	Base Prices		Wood Square Edge Suffix SW	Options (Add \$ to Base Price)	
					Laminate	Wood			
					Vinyl 3 mm Edge No Suffix	Vinyl P-Edge Suffix P		Customiz Stain on Wood	Full-Fill Finish
24"	24"	48"	48"	UC224848K	\$ 920	\$1025	\$1160	+\$50	+\$50
24"	24"	60"	60"	UC226060K	\$1224	\$1339	N.A.	N.A.	N.A.

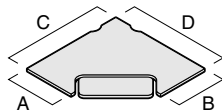

Corner, Curved-Front Worksurfaces

Laminate or Wood Veneer

SIN 711.1



Tip: Supports must be specified separately, including side support brackets for rear corner support in panel-mounted applications.

Standard Includes

- Worksurface: laminate or wood veneer
- Laminate worksurface:
 - Vinyl 3 mm edge profile or plastic P-edge profile on front edge
 - Plastic default flat profile on side and back edges
- Wood worksurface:
 - Wood 3 mm edge profile on front edge
 - Matching veneer flat profile on side and back edges
- Cable scallop on back edge

Required to Specify

- 1 Style number with appropriate edge profile suffix in the space provided
 - P** Laminate with vinyl P-edge
 - SW** Wood with square edge
 - ▶ See edge profiles below
- 2 Laminate or wood color number for worksurface
- 3 Plastic color number for front edge on laminate worksurface, if selected
- 4 Options, if selected (see below)
 - ▶ See *Surface Materials*, page D102.

Options

Options	Price	Required to Specify
Surface Materials		
Laminate worksurfaces		
• Accent laminate	+\$60	▶ See <i>Surface Materials Reference Manual</i> .
• Open Line laminate	+\$60 plus cost of laminate	▶ See <i>Surface Materials Reference Manual</i> .
Wood veneer worksurfaces		
• Customiz stain	Prices below	Specify with <i>Customiz stain</i> . ▶ See <i>Surface Materials Reference Manual</i> . Specify full-fill finish number.
• Full-fill finish	Prices below	
Scallops		
• Omit scallop	No cost	Specify <i>omit scallop</i> .
Related Products		
• Panel-mounted Universal Systems worksurface supports		▶ Page D38
• Legs and supports for Universal Systems Worksurfaces		▶ Page D45
• Worksurface screens		▶ Page D77
• Worksurface power and communication components		▶ Page D81

Tip: To specify 3 mm edge profile, no suffix is required. For all other edge profiles, add a suffix to the style number (for example, US1830 becomes US1830SW for wood with square edge profile).

Specification Information

Planning Dimensions				Style Number	Base Prices		Wood Square Edge	Options	
A	B	C	D		Laminate	Wood		(Add \$ to Base Price)	Full-Fill
					Vinyl 3 mm Edge	Vinyl P-Edge	Wood Square Edge	Customiz Stain on Wood	Finish
					No Suffix	Suffix P	Suffix SW		
18"	18"	42"	42"	UCC114242	\$331	\$421	\$581	+\$48	+\$48
18"	24"	42"	42"	UCC124242	\$360	\$450	\$610	+\$48	+\$48
24"	18"	42"	42"	UCC214242	\$360	\$450	\$610	+\$48	+\$48
24"	24"	36"	36"	UCC223636	\$343	\$423	\$593	+\$48	+\$48
24"	24"	42"	42"	UCC224242	\$375	\$465	\$625	+\$48	+\$48
24"	24"	48"	48"	UCC224848	\$420	\$510	\$670	+\$50	+\$50
24"	24"	60"	60"	UCC226060	\$724	\$824	N.A.	N.A.	N.A.
30"	30"	42"	42"	UCC334242	\$411	\$501	\$661	+\$49	+\$49
30"	30"	48"	48"	UCC334848	\$459	\$549	\$709	+\$52	+\$52

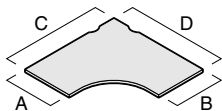

Extended Corner, Straight-Front Worksurfaces

Laminate or Wood Veneer

SIN 711.1



Tip: Illustration above shows a left-hand worksurface.

Tip: Supports must be specified separately, including side support brackets for rear corner support in panel-mounted applications.

Tip: Reinforcing channel (TS7WKSPT) is recommended to add support to worksurfaces that have 60" or more of unsupported knee-space. Must be specified separately.
▶ Page D40

Standard Includes		Required to Specify
<ul style="list-style-type: none"> • Worksurface: laminate or wood veneer • Laminate worksurface: <ul style="list-style-type: none"> –Vinyl 3 mm edge profile or plastic P-edge profile on front edge –Plastic default flat profile on side and back edges • Wood worksurface: <ul style="list-style-type: none"> –Wood 3 mm edge profile on front edge –Matching veneer flat profile on side and back edges • Cable scallops on back edges 		<p>1 Style number with appropriate edge profile suffix in the space provided</p> <p>P Laminate with vinyl P-edge SW Wood with square edge ▶ See edge profiles at right</p> <p>2 Laminate or wood color number for worksurface</p> <p>3 Plastic color number for front edge on laminate worksurface, if selected</p> <p>4 Options, if selected (see below) ▶ See <i>Surface Materials</i>, page D102.</p>
Options	Price	Required to Specify
Surface Materials	<p>Laminate worksurfaces</p> <ul style="list-style-type: none"> • Accent laminate +\$60 • Open Line laminate +\$60 <p>plus cost of laminate</p> <hr/> <p>Wood veneer worksurfaces</p> <ul style="list-style-type: none"> • Customiz stain Prices at right • Full-fill finish Prices at right 	<p>▶ See <i>Surface Materials Reference Manual</i>.</p> <p>▶ See <i>Surface Materials Reference Manual</i>.</p> <hr/> <p>Specify with <i>Customiz stain</i>. ▶ See <i>Surface Materials Reference Manual</i>. Specify full-fill finish number.</p> <hr/> <p>Specify <i>omit scallops</i>.</p>
Scallops	<ul style="list-style-type: none"> • Omit scallops No cost 	
Related Products	<ul style="list-style-type: none"> • Panel-mounted Universal Systems worksurface supports • Legs and supports for Universal Systems Worksurfaces • Reinforcing channel • Worksurface screens • Worksurface power and communication components 	<p>▶ Page D38</p> <p>▶ Page D45</p> <p>▶ Page D40</p> <p>▶ Page D77</p> <p>▶ Page D81</p>

Tip: To specify 3 mm edge profile, no suffix is required. For all other edge profiles, add a suffix to the style number (for example, US1830_ becomes US1830SW for wood with square edge profile).

Specification Information

Planning Dimensions				Style Number	Base Prices		Options (Add \$ to Base Price)
A	B	C	D		Vinyl 3 mm Edge	Wood Square Edge	
					No Suffix	Suffix P	Customiz: Full-Fill Stain on: Finish Wood

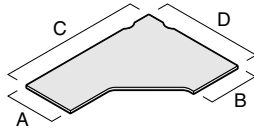

Left-Hand Worksurfaces

24"	24"	60"	42"	UE2202L_	\$596	\$696	\$ 866	+\$54	+\$54
24"	24"	66"	42"	UE2262L_	\$651	\$751	\$ 921	+\$68	+\$68
24"	24"	72"	42"	UE2222L_	\$705	\$805	\$ 975	+\$69	+\$69
24"	24"	60"	48"	UE2208L_	\$607	\$707	\$ 877	+\$68	+\$68
24"	24"	66"	48"	UE2268L_	\$663	\$763	\$ 933	+\$69	+\$69
24"	24"	72"	48"	UE2228L_	\$718	\$818	\$ 988	+\$71	+\$71
24"	30"	60"	48"	UE2308L_	\$669	\$769	\$ 939	+\$69	+\$69
24"	30"	66"	48"	UE2368L_	\$724	\$824	\$ 994	+\$71	+\$71
24"	30"	72"	48"	UE2328L_	\$779	\$879	\$1049	+\$72	+\$72
30"	24"	60"	48"	UE3208L_	\$669	\$769	\$ 939	+\$69	+\$69
30"	24"	66"	48"	UE3268L_	\$724	\$824	\$ 994	+\$71	+\$71
30"	24"	72"	48"	UE3228L_	\$779	\$879	\$1049	+\$72	+\$72
30"	30"	60"	48"	UE3308L_	\$700	\$800	\$ 970	+\$71	+\$71
30"	30"	66"	48"	UE3368L_	\$755	\$855	\$1025	+\$72	+\$72
30"	30"	72"	48"	UE3328L_	\$809	\$909	\$1079	+\$74	+\$74

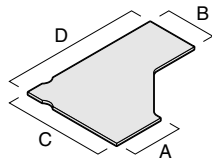

Right-Hand Worksurfaces

24"	24"	42"	60"	UE2220R_	\$596	\$696	\$ 866	+\$54	+\$54
24"	24"	42"	66"	UE2226R_	\$651	\$751	\$ 921	+\$68	+\$68
24"	24"	42"	72"	UE2222R_	\$705	\$805	\$ 975	+\$69	+\$69
24"	24"	48"	60"	UE2280R_	\$607	\$707	\$ 877	+\$68	+\$68
24"	24"	48"	66"	UE2286R_	\$663	\$763	\$ 933	+\$69	+\$69
24"	24"	48"	72"	UE2282R_	\$718	\$818	\$ 988	+\$71	+\$71
24"	30"	48"	60"	UE2380R_	\$669	\$769	\$ 939	+\$69	+\$69
24"	30"	48"	66"	UE2386R_	\$724	\$824	\$ 994	+\$71	+\$71
24"	30"	48"	72"	UE2382R_	\$779	\$879	\$1049	+\$72	+\$72
30"	24"	48"	60"	UE3280R_	\$669	\$769	\$ 939	+\$69	+\$69
30"	24"	48"	66"	UE3286R_	\$724	\$824	\$ 994	+\$71	+\$71
30"	24"	48"	72"	UE3282R_	\$779	\$879	\$1049	+\$72	+\$72
30"	30"	48"	60"	UE3380R_	\$700	\$800	\$ 970	+\$71	+\$71
30"	30"	48"	66"	UE3386R_	\$755	\$855	\$1025	+\$72	+\$72
30"	30"	48"	72"	UE3382R_	\$809	\$909	\$1079	+\$74	+\$74

Extended Corner, Straight-Front Worksurfaces with Adjustable Keyboard Shelf

Laminate or Wood Veneer

SIN 711.1

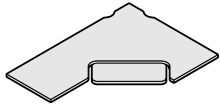

Tip: Illustration above shows a left-hand worksurface.

Tip: Supports must be specified separately, including side support brackets for rear corner support in panel-mounted applications.

Tip: Keyboard mechanism requires field attachment to the worksurface and keyboard shelf.

Tip: To specify 3 mm edge profile, no suffix is required. For all other edge profiles, add a suffix to the style number (for example, US1830 becomes US1830SW for wood with square edge profile).

Standard Includes

- Worksurface: laminate or wood veneer
- Laminate worksurface:
 - Vinyl 3 mm edge profile or plastic P-edge profile on front edge
 - Plastic default flat profile on side and back edges
 - Vinyl 3 mm edge profile or plastic P-edge profile on all edges of keyboard shelf
- Wood worksurface:
 - Wood 3 mm edge profile on front edge
 - Matching veneer flat profile on side and back edges
 - Wood 3 mm edge profile on all edges of keyboard shelf
- Cable scallops on back edges
- Keyboard mechanism

Required to Specify

- 1 Style number with appropriate edge profile suffix in the space provided
 - P** Laminate with vinyl P-edge
 - SW** Wood with square edge
 - ▶ See edge profiles below
- 2 Laminate or wood color number for worksurface
- 3 Plastic color number for edges on laminate worksurface, if selected
- 4 Options, if selected (see below)
 - ▶ See *Surface Materials*, page D102.

Options Price Required to Specify

Surface Materials	Options	Price	Required to Specify
	Laminate worksurfaces		
	• Accent laminate	+\$60	▶ See <i>Surface Materials Reference Manual</i> .
	• Open Line laminate	+\$60 plus cost of laminate	▶ See <i>Surface Materials Reference Manual</i> .
	Wood veneer worksurfaces		
	• Customiz stain	Prices below	Specify with <i>Customiz stain</i> . ▶ See <i>Surface Materials Reference Manual</i> .
	• Full-fill finish	Prices below	Specify full-fill finish number.
Scallops	• Omit scallops	No cost	Specify <i>omit scallops</i> .
Related Products	• Panel-mounted Universal Systems worksurface supports		▶ Page D38
	• Legs and supports for Universal Systems Worksurfaces		▶ Page D45
	• Worksurface screens		▶ Page D77
	• Worksurface power and communication components		▶ Page D81

Specification Information

Planning Dimensions A B C D	Style Number	Base Prices		Wood Square Edge Suffix SW	Options (Add \$ to Base Price) Customiz Stain on Wood Full-Fill Finish
		Laminate	Wood		
		Vinyl 3 mm Edge No Suffix	Vinyl P-Edge Suffix P		

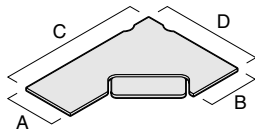

Left-Hand Worksurfaces

24"	24"	60"	48"	UE2208KL __	\$1107	\$1222	\$1377	+\$68	+\$68
24"	24"	66"	48"	UE2268KL __	\$1163	\$1278	\$1433	+\$69	+\$69
24"	24"	72"	48"	UE2228KL __	\$1218	\$1333	\$1488	+\$71	+\$71

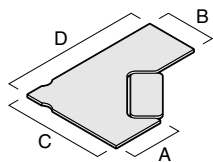

Right-Hand Worksurfaces

24"	24"	48"	60"	UE2280KR __	\$1107	\$1222	\$1377	+\$68	+\$68
24"	24"	48"	66"	UE2286KR __	\$1163	\$1278	\$1433	+\$69	+\$69
24"	24"	48"	72"	UE2282KR __	\$1218	\$1333	\$1488	+\$71	+\$71

Extended Corner, Straight-
Front Worksurfaces with
Adjustable Keyboard Shelf

SIN 711.1

Extended Corner, Curved-Front Worksurfaces

Laminate or Wood Veneer

SIN 711.1



Tip: Illustration above shows a left-hand worksurface.



Tip: Supports must be specified separately, including side support brackets for rear corner support in panel-mounted applications.

Tip: Reinforcing channel (TS7WKSPT) is recommended to add support to worksurfaces that have 60" or more of unsupported knee-space. Must be specified separately.
▶ Page D40

Standard Includes		Required to Specify
<ul style="list-style-type: none"> • Worksurface: laminate or wood veneer • Laminate worksurface: <ul style="list-style-type: none"> –Vinyl 3 mm edge profile or plastic P-edge profile on front edge –Plastic default flat profile on side and back edges • Wood worksurface: <ul style="list-style-type: none"> –Wood 3 mm edge profile on front edge –Matching veneer flat profile on side and back edges • Cable scallops on back edges 		1 Style number with appropriate edge profile suffix in the space provided P Laminate with vinyl P-edge SW Wood with square edge ▶ See edge profiles at right 2 Laminate or wood color number for worksurface 3 Plastic color number for front edge on laminate worksurface, if selected 4 Options, if selected (see below) ▶ See <i>Surface Materials</i> , page D102.
Options	Price	Required to Specify
Surface Materials	Laminate worksurfaces <ul style="list-style-type: none"> • Accent laminate +\$60 • Open Line laminate +\$60 plus cost of laminate	▶ See <i>Surface Materials Reference Manual</i> . ▶ See <i>Surface Materials Reference Manual</i> .
	Wood veneer worksurfaces <ul style="list-style-type: none"> • Customiz stain Prices at right • Full-fill finish Prices at right 	Specify with <i>Customiz stain</i> . ▶ See <i>Surface Materials Reference Manual</i> . Specify full-fill finish number.
Scallops	<ul style="list-style-type: none"> • Omit scallops No cost 	Specify <i>omit scallops</i> .
Related Products	<ul style="list-style-type: none"> • Panel-mounted Universal Systems worksurface supports • Legs and supports for Universal Systems Worksurfaces • Reinforcing channel • Worksurface screens • Worksurface power and communication components 	▶ Page D38 ▶ Page D45 ▶ Page D40 ▶ Page D77 ▶ Page D81

Tip: To specify 3 mm edge profile, no suffix is required. For all other edge profiles, add a suffix to the style number (for example, US1830_ becomes US1830SW for wood with square edge profile).

Specification Information

Planning Dimensions				Style Number	Base Prices		Options
A	B	C	D		Laminate	Wood	
							
					Vinyl 3 mm Edge	Vinyl P-Edge	Wood Square Edge
					No Suffix	Suffix P	Suffix SW
							(Add \$ to Base Price)
							Customiz : Full-Fill
							Stain on : Finish
							Wood :

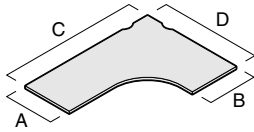

Left-Hand Worksurfaces

24"	24"	60"	42"	UEC2202L_	\$596	\$696	\$ 891	+\$54	+\$54
24"	24"	66"	42"	UEC2262L_	\$651	\$751	\$ 946	+\$68	+\$68
24"	24"	72"	42"	UEC2222L_	\$705	\$805	\$1000	+\$69	+\$69
24"	24"	60"	48"	UEC2208L_	\$607	\$707	\$ 902	+\$68	+\$68
24"	24"	66"	48"	UEC2268L_	\$663	\$763	\$ 958	+\$69	+\$69
24"	24"	72"	48"	UEC2228L_	\$718	\$818	\$1013	+\$71	+\$71
24"	30"	60"	48"	UEC2308L_	\$669	\$769	\$ 964	+\$69	+\$69
24"	30"	66"	48"	UEC2368L_	\$724	\$824	\$1019	+\$71	+\$71
24"	30"	72"	48"	UEC2328L_	\$779	\$879	\$1074	+\$72	+\$72
30"	24"	60"	48"	UEC3208L_	\$669	\$769	\$ 964	+\$69	+\$69
30"	24"	66"	48"	UEC3268L_	\$724	\$824	\$1019	+\$71	+\$71
30"	24"	72"	48"	UEC3228L_	\$779	\$879	\$1074	+\$72	+\$72
30"	30"	60"	48"	UEC3308L_	\$700	\$800	\$ 995	+\$71	+\$71
30"	30"	66"	48"	UEC3368L_	\$755	\$855	\$1050	+\$72	+\$72
30"	30"	72"	48"	UEC3328L_	\$809	\$909	\$1104	+\$74	+\$74

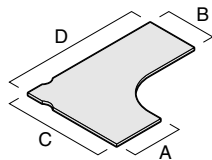

Right-Hand Worksurfaces

24"	24"	42"	60"	UEC2220R_	\$596	\$696	\$ 891	+\$54	+\$54
24"	24"	42"	66"	UEC2226R_	\$651	\$751	\$ 946	+\$68	+\$68
24"	24"	42"	72"	UEC2222R_	\$705	\$805	\$1000	+\$69	+\$69
24"	24"	48"	60"	UEC2280R_	\$607	\$707	\$ 902	+\$68	+\$68
24"	24"	48"	66"	UEC2286R_	\$663	\$763	\$ 958	+\$69	+\$69
24"	24"	48"	72"	UEC2282R_	\$718	\$818	\$1013	+\$71	+\$71
24"	30"	48"	60"	UEC2380R_	\$669	\$769	\$ 964	+\$69	+\$69
24"	30"	48"	66"	UEC2386R_	\$724	\$824	\$1019	+\$71	+\$71
24"	30"	48"	72"	UEC2382R_	\$779	\$879	\$1074	+\$72	+\$72
30"	24"	48"	60"	UEC3280R_	\$669	\$769	\$ 964	+\$69	+\$69
30"	24"	48"	66"	UEC3286R_	\$724	\$824	\$1019	+\$71	+\$71
30"	24"	48"	72"	UEC3282R_	\$779	\$879	\$1074	+\$72	+\$72
30"	30"	48"	60"	UEC3380R_	\$700	\$800	\$ 995	+\$71	+\$71
30"	30"	48"	66"	UEC3386R_	\$755	\$855	\$1050	+\$72	+\$72
30"	30"	48"	72"	UEC3382R_	\$809	\$909	\$1104	+\$74	+\$74

Corner, 120° Worksurfaces

Laminate or Wood Veneer

SIN 711.1



Tip: Supports must be specified separately, including side support brackets for rear corner support in panel-mounted applications.

Tip: Corner, 120° worksurfaces cannot be supported by Montage frames.

▶ See Montage chapter in the Specials Handbook for 120° planning.

Standard Includes	Required to Specify
-------------------	---------------------

- Worksurface: laminate or wood veneer
- Laminate worksurface:
 - Vinyl 3 mm edge profile or plastic P-edge profile on front edge
 - Plastic default flat profile on side and back edges
- Wood worksurface:
 - Wood 3 mm edge profile on front edge
 - Matching veneer flat profile on side and back edges
- Cable scallop on back edge



- 1 Style number with appropriate edge profile suffix in the space provided
 - P** Laminate with vinyl P-edge
 - SW** Wood with square edge
 - ▶ See edge profiles below
 - 2 Laminate or wood color number for worksurface
 - 3 Plastic color number for front edge on laminate worksurface, if selected
 - 4 Options, if selected (see below)
- ▶ See Surface Materials, page D102.

Surface Materials	Options	Price	Required to Specify
-------------------	---------	-------	---------------------

Surface Materials	Laminate worksurfaces		
	<ul style="list-style-type: none"> • Accent laminate +\$60 • Open Line laminate +\$60 plus cost of laminate 		<ul style="list-style-type: none"> ▶ See Surface Materials Reference Manual. ▶ See Surface Materials Reference Manual.
	Wood veneer worksurfaces		
	<ul style="list-style-type: none"> • Customiz stain Prices below • Full-fill finish Prices below 		<ul style="list-style-type: none"> Specify with Customiz stain. ▶ See Surface Materials Reference Manual. Specify full-fill finish number.
Scallops	<ul style="list-style-type: none"> • Omit scallop 	No cost	Specify omit scallop.
Related Products	<ul style="list-style-type: none"> • Panel-mounted Universal Systems worksurface supports • Legs and supports for Universal Systems Worksurfaces • Worksurface screens • Worksurface power and communication components 		<ul style="list-style-type: none"> ▶ Page D38 ▶ Page D45 ▶ Page D77 ▶ Page D81

Tip: To specify 3 mm edge profile, no suffix is required. For all other edge profiles, add a suffix to the style number (for example, US1830_ becomes US1830SW for wood with square edge profile).

Specification Information

• Planning Dimensions A B C D	• Style Number	Base Prices		• Wood Square Edge Suffix SW	• Options (Add \$ to Base Price) Customiz : Full-Fill Stain on : Finish Wood :
		• Vinyl 3 mm Edge No Suffix	• Vinyl P-Edge Suffix P		
					



Freestanding or Panel-Mounted on Kick, Answer, and Pathways Technology Wall Panels

24"	24"	36"	36"	UB223636 _	\$635	\$725	\$880	+\$69	+\$69
24"	24"	42"	42"	UB224242 _	\$660	\$750	\$905	+\$71	+\$71
24"	24"	48"	48"	UB224848 _	\$685	\$775	\$930	+\$72	+\$72
30"	30"	36"	36"	UB333636 _	\$660	\$750	\$905	+\$71	+\$71
30"	30"	42"	42"	UB334242 _	\$685	\$775	\$930	+\$72	+\$72
30"	30"	48"	48"	UB334848 _	\$710	\$800	\$955	+\$74	+\$74
:	:	:	:	:	:	:	:	:	:

Corner, 120° Worksurfaces with Adjustable Keyboard Shelf

Laminate or Wood Veneer
SIN 711.1

Corner, 120° Worksurfaces with Adjustable Keyboard Shelf



Tip: Supports must be specified separately, including side support brackets for rear corner support in panel-mounted applications.

Tip: Corner, 120° worksurfaces cannot be supported by Montage frames.

▶ See Montage chapter in the Specials Handbook for 120° planning.

Tip: Keyboard mechanism requires field attachment to the worksurface and keyboard shelf.

Tip: To specify 3 mm edge profile, no suffix is required. For all other edge profiles, add a suffix to the style number (for example, US1830 becomes US1830SW for wood with square edge profile).

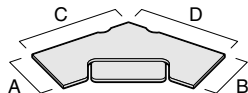

Standard Includes Required to Specify

- | | |
|--|--|
| <ul style="list-style-type: none"> • Worksurface: laminate or wood veneer • Laminate worksurface: <ul style="list-style-type: none"> –Vinyl 3 mm edge profile or plastic P-edge profile on front edge –Plastic default flat profile on side and back edges –Vinyl 3 mm edge profile or plastic P-edge profile on all edges of keyboard shelf • Wood worksurface: <ul style="list-style-type: none"> –Wood 3 mm edge profile on front edge –Matching veneer flat profile on side and back edges –Wood 3 mm edge profile on all edges of keyboard shelf • Cable scallops on back edges • Keyboard mechanism | <ol style="list-style-type: none"> 1 Style number with appropriate edge profile suffix in the space provided <ul style="list-style-type: none"> P Laminate with vinyl P-edge SW Wood with square edge ▶ See edge profiles below 2 Laminate or wood color number for worksurface 3 Plastic color number for edges on laminate worksurface, if selected 4 Options, if selected (see below) <ul style="list-style-type: none"> ▶ See <i>Surface Materials</i>, page D102. |
|--|--|

Options Price Required to Specify

Options	Price	Required to Specify
Surface Materials		
Laminate worksurfaces		
• Accent laminate	+\$60	▶ See <i>Surface Materials Reference Manual</i> .
• Open Line laminate	+\$60 plus cost of laminate	▶ See <i>Surface Materials Reference Manual</i> .
Wood veneer worksurfaces		
• Customiz stain	Prices below	Specify with <i>Customiz stain</i> . ▶ See <i>Surface Materials Reference Manual</i> .
• Full-fill finish	Prices below	Specify full-fill finish number.
Scallops		
• Omit scallops	No cost	Specify <i>omit scallops</i> .
Related Products		
• Panel-mounted Universal Systems worksurface supports		▶ Page D38
• Legs and supports for Universal Systems Worksurfaces		▶ Page D45
• Worksurface screens		▶ Page D77
• Worksurface power and communication components		▶ Page D81

Specification Information

• Planning Dimensions A B C D	• Style Number	Base Prices		• Wood Square Edge Suffix SW	• Options (Add \$ to Base Price) Customiz : Full-Fill Stain on : Finish Wood :
		Laminate	Wood		
		• Vinyl 3 mm Edge No Suffix	• Vinyl P-Edge Suffix P		

Freestanding or Panel-Mounted on Kick, Answer, and Pathways Technology Wall Panels

24"	24"	42"	42"	Style Number	Laminate	Wood	Options	Options	
24"	24"	42"	42"	UB224242K	\$1160	\$1265	\$1405	+\$71	+\$71
24"	24"	48"	48"	UB224848K	\$1185	\$1290	\$1430	+\$72	+\$72
30"	30"	42"	42"	UB334242K	\$1185	\$1290	\$1430	+\$72	+\$72
30"	30"	48"	48"	UB334848K	\$1210	\$1315	\$1455	+\$74	+\$74

Worksurfaces

Spanner Worksurfaces

Laminate or Wood Veneer

SIN 711.1

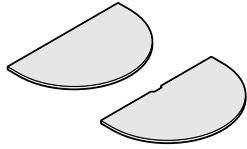

Tip: Supports for freestanding and panel-mounted applications must be specified separately.

Tip: P-edge profile and wood veneer spanner worksurfaces include alignment slots to accept two cabby legs or two elliptical legs for column support in panel-mounted applications or four cabby legs or four elliptical legs for freestanding worksurfaces.

Tip: To specify 3 mm edge profile, no suffix is required. For all other edge profiles, add a suffix to the style number (for example, US1830__ becomes US1830SW for wood with square edge profile).

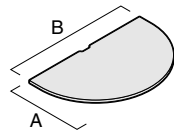
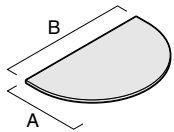

Standard Includes	Required to Specify
-------------------	---------------------

- Worksurface: laminate or wood veneer
- Laminate worksurface:
 - Vinyl 3 mm edge profile or plastic P-edge profile on front edge
 - Plastic default flat profile on side and back edges
- Wood worksurface:
 - Wood 3 mm edge profile on front edge
 - Matching veneer flat profile on side and back edges

- 1 Style number with appropriate edge profile suffix in the space provided
 - P** Laminate with vinyl P-edge
 - SW** Wood with square edge
 - ▶ See edge profiles below
- 2 Laminate or wood color number for worksurface
- 3 Plastic color number for front edge on laminate worksurface, if selected
- 4 Options, if selected (see below)
 - ▶ See *Surface Materials*, page D102.

Surface Materials	Options	Price	Required to Specify
-------------------	---------	-------	---------------------

Surface Materials	Laminate worksurfaces		▶ See <i>Surface Materials Reference Manual</i> . ▶ See <i>Surface Materials Reference Manual</i> .
	• Accent laminate	+\$60	
	• Open Line laminate	+\$60 plus cost of laminate	
	Wood veneer worksurfaces		
	• Customiz stain	Prices below	Specify with <i>Customiz stain</i> . ▶ See <i>Surface Materials Reference Manual</i> . Specify full-fill finish number.
	• Full-fill finish	Prices below	
Related	• Panel-mounted Universal Systems worksurface supports		▶ Page D38
Products	• Legs and supports for Universal Systems Worksurfaces		▶ Page D45
	• Adjustable column		▶ Page D45
	• Worksurface screens		▶ Page D77
	• Worksurface power and communication components		▶ Page D81

Specification Information

• Planning Dimensions A B	• Style Number	Base Prices		• Wood Square Edge Suffix SW	• Options (Add \$ to Base Price) • Customiz : Full-Fill • Stain on : Finish • Wood :
		Laminate	Wood		
		• Vinyl 3 mm Edge No Suffix	• Vinyl P-Edge Suffix P		

For Freestanding Applications without Panels

29½" 47"	USPC47__	\$354	\$424	\$624	+\$53	+\$53
35½" 59"	USPC59__	\$450	\$520	\$720	+\$57	+\$57

With 2" Notch for Use with Kick Panels

31" 50"	USPC50__	\$354	\$424	\$624	+\$53	+\$53
37" 62"	USPC62__	\$450	\$520	\$720	+\$57	+\$57

With 3" Notch for Use with Answer Panels and Montage Frames

31½" 51"	USPC51__	\$354	\$424	\$624	+\$53	+\$53
37½" 63"	USPC63__	\$450	\$520	\$720	+\$57	+\$57

With 4" Notch for Use with Pathways Technology Wall Panels

32" 52"	USPC52__	\$354	\$424	\$624	+\$53	+\$53
38" 64"	USPC64__	\$450	\$520	\$720	+\$57	+\$57

Bullet Peninsula, Straight-Front Worksurfaces

Bullet Peninsula,
Straight-Front Worksurfaces

Laminate
SIN 711.1

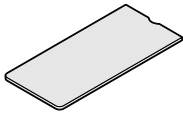

Tip: Bullet peninsula, straight-front worksurfaces are available in laminate only.

Tip: Supports for freestanding and panel-mounted applications must be specified separately.

Tip: P-edge profile and wood veneer bullet peninsula, straight-front worksurfaces include alignment slots to accept two cabby legs or two elliptical legs for column support in panel-mounted applications.

Tip: Bullet peninsula, straight-front worksurfaces are recommended for use with other straight-front shapes such as corner, straight-front worksurfaces.

▶ Page D6

Tip: To specify 3 mm edge profile, no suffix is required. For all other edge profiles, add a suffix to the style number (for example, US1830__ becomes US1830SW for wood with square edge profile).

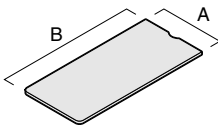

Standard Includes Required to Specify

- Worksurface: laminate
- Vinyl 3 mm edge profile or plastic P-edge profile on front edge
- Plastic default flat profile on back edge
- Cable scallop on back edge

- 1 Style number with appropriate edge profile suffix in the space provided
 - ▶ Laminate with vinyl P-edge
 - ▶ See edge profiles below
 - 2 Laminate color number for worksurface
 - 3 Plastic color number for front edge
 - 4 Options, if selected (see below)
- ▶ See *Surface Materials*, page D102.

	Options	Price	Required to Specify
Surface Materials	<ul style="list-style-type: none"> • Accent laminate • Open Line laminate 	+\$60 +\$60 plus cost of laminate	<ul style="list-style-type: none"> ▶ See <i>Surface Materials Reference Manual</i>. ▶ See <i>Surface Materials Reference Manual</i>.
Scallops	<ul style="list-style-type: none"> • Omit scallop 	No cost	Specify <i>omit scallop</i> .
Related Products	<ul style="list-style-type: none"> • Panel-mounted Universal Systems worksurface supports • Legs and supports for Universal Systems Worksurfaces • Adjustable column • Worksurface screens • Worksurface power and communication components 		<ul style="list-style-type: none"> ▶ Page D38 ▶ Page D45 ▶ Page D45 ▶ Page D77 ▶ Page D81

Specification Information

Planning Dimensions A B	Style Number	Base Prices		Wood Square Edge Suffix SW	Options (Add \$ to Base Price)	
		Laminate	Wood			
		Vinyl 3 mm Edge No Suffix	Vinyl P-Edge Suffix P		Customiz : Full-Fill Stain on : Finish Wood : Wood	
30" 60"	UPB3060__	\$491	\$581	N.A.	N.A.	N.A.
30" 66"	UPB3066__	\$502	\$592	N.A.	N.A.	N.A.
30" 72"	UPB3072__	\$512	\$602	N.A.	N.A.	N.A.

Worksurfaces

Bullet Peninsula, Curved-Front Worksurfaces

Laminate or Wood Veneer

SIN 711.1

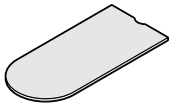

Tip: Supports for freestanding and panel-mounted applications must be specified separately.

Tip: P-edge profile and wood veneer bullet peninsula, curved-front worksurfaces include alignment slots to accept two caddy legs or two elliptical legs for support in panel-mounted applications.

Tip: Bullet peninsula, curved-front worksurfaces are recommended for use with other curved-front shapes such as corner, curved-front worksurfaces.

▶ Page D8

Tip: To specify 3 mm edge profile, no suffix is required. For all other edge profiles, add a suffix to the style number (for example, US1830 becomes US1830SW for wood with square edge profile).

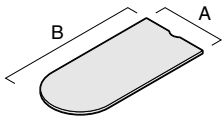

Standard Includes		Required to Specify	
<ul style="list-style-type: none"> Worksurface: laminate or wood veneer Laminate worksurface: <ul style="list-style-type: none"> -Vinyl 3 mm edge profile or plastic P-edge profile on front edge -Plastic default flat profile on side and back edges Wood worksurface: <ul style="list-style-type: none"> -Wood 3 mm edge profile on front edge -Matching veneer flat profile on side and back edges Cable scallop on back edge 		1 Style number with appropriate edge profile suffix in the space provided P Laminate with vinyl P-edge SW Wood with square edge ▶ See edge profiles below 2 Laminate or wood color number for worksurface 3 Plastic color number for front edge on laminate worksurface, if selected 4 Options, if selected (see below) ▶ See <i>Surface Materials</i> , page D102.	
Surface Materials	Options	Price	Required to Specify
	Laminate worksurfaces		
	<ul style="list-style-type: none"> Accent laminate +\$60 Open Line laminate +\$60 plus cost of laminate 		▶ See <i>Surface Materials Reference Manual</i> . ▶ See <i>Surface Materials Reference Manual</i> .
	Wood veneer worksurfaces		
	<ul style="list-style-type: none"> Customiz stain Prices below Full-fill finish Prices below 		Specify with <i>Customiz stain</i> . ▶ See <i>Surface Materials Reference Manual</i> . Specify full-fill finish number.
Scallops	<ul style="list-style-type: none"> Ornit scallop 	No cost	Specify <i>omit scallop</i> .
Related Products	<ul style="list-style-type: none"> Panel-mounted Universal Systems worksurface supports Legs and supports for Universal Systems Worksurfaces Adjustable column Worksurface screens Worksurface power and communication components 		▶ Page D38 ▶ Page D45 ▶ Page D45 ▶ Page D77 ▶ Page D81

Planning Dimensions A B		Style Number	Base Prices			Options (Add \$ to Base Price) Customiz : Full-Fill Stain on : Finish Wood :	
			Vinyl 3 mm Edge No Suffix	Vinyl P-Edge Suffix P	Wood Square Edge Suffix SW		
30"	60"	UPBC3060__	\$491	\$581	\$761	+\$50	+\$50
30"	66"	UPBC3066__	\$502	\$592	\$772	+\$52	+\$52
30"	72"	UPBC3072__	\$512	\$602	\$782	+\$54	+\$54

Angled Peninsula, Straight-Front Worksurfaces

Angled Peninsula,
Straight-Front Worksurfaces

Laminate or Wood Veneer

SIN 711.1

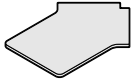

Tip: Supports for freestanding and panel-mounted applications must be specified separately.

Tip: P-edge profile and wood veneer angled peninsula, straight-front worksurfaces include alignment slots to accept two cabby legs or two elliptical legs for support in panel-mounted applications.

Tip: Angled peninsula, straight-front worksurfaces are recommended for use with other straight-front shapes such as corner, straight-front worksurfaces.
▶ Page D6

Tip: To specify 3 mm edge profile, no suffix is required. For all other edge profiles, add a suffix to the style number (for example, US1830_ becomes US1830SW for wood with square edge profile).

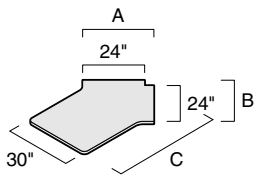

Standard Includes

- Worksurface: laminate or wood veneer
- Laminate worksurface:
 - Vinyl 3 mm edge profile or plastic P-edge profile on front edge
 - Plastic default flat profile on side and back edges
- Wood worksurface:
 - Wood 3 mm edge profile on front edge
 - Matching veneer flat profile on side and back edges

Required to Specify

- 1 Style number with appropriate edge profile suffix in the space provided
 - P** Laminate with vinyl P-edge
 - SW** Wood with square edge
 - ▶ See edge profiles below
- 2 Laminate or wood color number for worksurface
- 3 Plastic color number for front edge on laminate worksurface, if selected
- 4 Options, if selected (see below)
 - ▶ See *Surface Materials*, page D102.

Options

Surface Materials	Options	Price	Required to Specify
	Laminate worksurfaces		
	• Accent laminate	+\$60	▶ See <i>Surface Materials Reference Manual</i> .
	• Open Line laminate	+\$60 plus cost of laminate	▶ See <i>Surface Materials Reference Manual</i> .
	Wood veneer worksurfaces		
	• Customiz stain	Prices below	Specify with <i>Customiz stain</i> . ▶ See <i>Surface Materials Reference Manual</i> . Specify full-fill finish number.
	• Full-fill finish	Prices below	
Related Products	• Panel-mounted Universal Systems worksurface supports		▶ Page D38
	• Legs and supports for Universal Systems Worksurfaces		▶ Page D45
	• Adjustable column		▶ Page D45
	• Worksurface power and communication components		▶ Page D81

Specification Information

Planning Dimensions A B C	Style Number	Base Prices		Wood Square Edge Suffix SW	Options (Add \$ to Base Price)
		Laminate	Wood		
		• Vinyl 3 mm Edge No Suffix	• Vinyl P-Edge Suffix P		• Customiz Stain on Wood
					• Full-Fill Finish

With 2" Notch for Use with Kick Panels

26"	26"	49"	UPA2648__	\$526	\$616	\$796	\$47	+\$47
-----	-----	-----	------------------	-------	-------	-------	------	-------

With 3" Notch for Use with Answer Panels and Montage Frames

27"	27"	50"	UPA2748__	\$526	\$616	\$796	+\$48	+\$48
-----	-----	-----	------------------	-------	-------	-------	-------	-------

With 4" Notch for Use with Pathways Technology Wall Panels

28"	28"	51"	UPA2848__	\$526	\$616	\$796	+\$49	+\$49
-----	-----	-----	------------------	-------	-------	-------	-------	-------

Angled Peninsula, Curved-Front Worksurfaces

Laminate or Wood Veneer

SIN 711.1



Tip: Supports for freestanding and panel-mounted applications must be specified separately.

Tip: P-edge profile and wood veneer angled peninsula, curved-front worksurfaces include alignment slots to accept two cabby legs or two elliptical legs for support in panel-mounted applications.

Tip: Angled peninsula, curved-front worksurfaces are recommended for use with other curved-front shapes such as corner, curved-front worksurfaces.

▶ Page D8

Tip: To specify 3 mm edge profile, no suffix is required. For all other edge profiles, add a suffix to the style number (for example, US1830_ becomes US1830SW for wood with square edge profile).

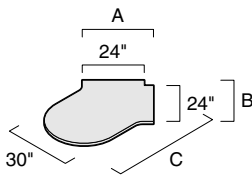

Standard Includes

- Worksurface: laminate or wood veneer
- Laminate worksurface:
 - Vinyl 3 mm edge profile or plastic P-edge profile on front edge
 - Plastic default flat profile on side and back edges
- Wood worksurface:
 - Wood 3 mm edge profile on front edge
 - Matching veneer flat profile on side and back edges

Required to Specify

- 1 Style number with appropriate edge profile suffix in the space provided
 - P** Laminate with vinyl P-edge
 - SW** Wood with square edge
 - ▶ See edge profiles below
- 2 Laminate or wood color number for worksurface
- 3 Plastic color number for front edge on laminate worksurface, if selected
- 4 Options, if selected (see below)
 - ▶ See *Surface Materials*, page D102.

Options

Surface Materials	Options	Price	Required to Specify
	Laminate worksurfaces		
	• Accent laminate	+\$60	▶ See <i>Surface Materials Reference Manual</i> .
• Open Line laminate	+\$60 plus cost of laminate		
	Wood veneer worksurfaces		
	• Customiz stain	Prices below	Specify with <i>Customiz stain</i> .
	• Full-fill finish	Prices below	▶ See <i>Surface Materials Reference Manual</i> . Specify full-fill finish number.

Related Products	Options	Price	Required to Specify
	• Panel-mounted Universal Systems worksurface supports		▶ Page D38
	• Legs and supports for Universal Systems Worksurfaces		▶ Page D45
	• Adjustable column		▶ Page D45
	• Worksurface power and communication components		▶ Page D81

Specification Information

Planning Dimensions A B C	Style Number	Base Prices		Wood Square Edge Suffix SW	Options (Add \$ to Base Price) Customiz Stain on Wood Full-Fill Finish
		Laminate	Wood		
		Vinyl 3 mm Edge No Suffix	Vinyl P-Edge Suffix P		

With 2" Notch for Use with Kick Panels								
26"	26"	49"	UPAC2648__	\$526	\$616	\$796	+\$47	+\$47
With 3" Notch for Use with Answer Panels and Montage Frames								
27"	27"	50"	UPAC2748__	\$526	\$616	\$796	+\$48	+\$48
With 4" Notch for Use with Pathways Technology Wall Panels								
28"	28"	51"	UPAC2848__	\$526	\$616	\$796	+\$49	+\$49

Jetty, Straight-Front Worksurfaces

Laminate or Wood Veneer

SIN 711.1

Jetty, Straight-Front Worksurfaces

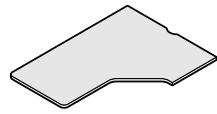

Tip: Illustration above shows a left-hand worksurface.

Tip: Supports for freestanding and panel-mounted applications must be specified separately.

Tip: P-edge profile and wood veneer jetty, straight-front worksurfaces include alignment slots to accept two cabby legs or two elliptical legs for support in panel-mounted applications.

Tip: Jetty, straight-front worksurfaces are recommended for use with other straight-front shapes such as corner, straight-front worksurfaces.
▶ Page D6

Tip: To specify 3 mm edge profile, no suffix is required. For all other edge profiles, add a suffix to the style number (for example, US1830 becomes US1830SW for wood with square edge profile).

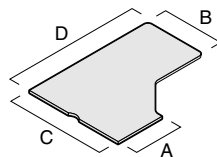
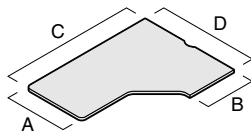

Standard Includes

- Worksurface: laminate or wood veneer
- Laminate worksurface:
 - Vinyl 3 mm edge profile or plastic P-edge profile on front edge
 - Plastic default flat profile on side and back edges
- Wood worksurface:
 - Wood 3 mm edge profile on front edge
 - Matching veneer flat profile on side and back edges
- Cable scallop on back edge

Required to Specify

- 1 Style number with appropriate edge profile suffix in the space provided
 - P** Laminate with vinyl P-edge
 - SW** Wood with square edge
 - ▶ See edge profiles below
- 2 Laminate or wood color number for worksurface
- 3 Plastic color number for front edge on laminate worksurface, if selected
- 4 Options, if selected (see below)
 - ▶ See *Surface Materials*, page D102.

Options

Surface Materials	Options	Price	Required to Specify
	Laminate worksurfaces		
	• Accent laminate	+\$60	▶ See <i>Surface Materials Reference Manual</i> .
	• Open Line laminate	+\$60 plus cost of laminate	▶ See <i>Surface Materials Reference Manual</i> .
	Wood veneer worksurfaces		
	• Customiz stain	Prices below	Specify with <i>Customiz stain</i> . ▶ See <i>Surface Materials Reference Manual</i> . Specify full-fill finish number.
	• Full-fill finish	Prices below	
Scallops	• Omit scallop	No cost	Specify <i>omit scallop</i> .
Related Products	• Panel-mounted Universal Systems worksurface supports		▶ Page D38
	• Legs and supports for Universal Systems Worksurfaces		▶ Page D45
	• Adjustable column		▶ Page D45
	• Worksurface screens		▶ Page D77
	• Worksurface power and communication components		▶ Page D81

Specification Information

• Planning Dimensions A B C D	• Style Number	Base Prices Laminate		Wood	• Options (Add \$ to Base Price)
		• Vinyl 3 mm Edge No Suffix	• Vinyl P-Edge Suffix P	• Wood Square Edge Suffix SW	
					• Customiz : Full-Fill • Stain on : Finish • Wood

Left-Hand Worksurfaces

30"	24"	66"	48"	UJ3268L	\$699	\$799	\$ 969	+\$68	+\$68
30"	24"	72"	48"	UJ3228L	\$724	\$824	\$1004	+\$70	+\$70
30"	24"	78"	48"	UJ3288L	\$747	\$847	\$1037	+\$74	+\$74
30"	30"	66"	48"	UJ3368L	\$722	\$822	\$ 992	+\$68	+\$68
30"	30"	72"	48"	UJ3328L	\$747	\$847	\$1027	+\$70	+\$70
30"	30"	78"	48"	UJ3388L	\$772	\$872	\$1062	+\$74	+\$74

Right-Hand Worksurfaces

24"	30"	48"	66"	UJ2386R	\$699	\$799	\$ 969	+\$68	+\$68
24"	30"	48"	72"	UJ2382R	\$724	\$824	\$1004	+\$70	+\$70
24"	30"	48"	78"	UJ2388R	\$747	\$847	\$1037	+\$74	+\$74
30"	30"	48"	66"	UJ3386R	\$722	\$822	\$ 992	+\$68	+\$68
30"	30"	48"	72"	UJ3382R	\$747	\$847	\$1027	+\$70	+\$70
30"	30"	48"	78"	UJ3388R	\$772	\$872	\$1062	+\$74	+\$74

Jetty, Curved-Front Worksurfaces

Laminate or Wood Veneer

SIN 711.1



Tip: Illustration above shows a left-hand work surface.

Tip: Supports for freestanding and panel-mounted applications must be specified separately.

Tip: P-edge profile and wood veneer jetty, curved-front worksurfaces include alignment slots to accept two cabby legs or two elliptical legs for support in panel-mounted applications.

Tip: Jetty, curved-front worksurfaces are recommended for use with other curved-front shapes such as corner, curved-front worksurfaces.
▶ Page D8

Tip: To specify 3 mm edge profile, no suffix is required. For all other edge profiles, add a suffix to the style number (for example, US1830__ becomes US1830SW for wood with square edge profile).

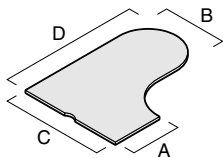
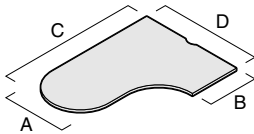

Standard Includes	Required to Specify
<ul style="list-style-type: none"> • Worksurface: laminate or wood veneer • Laminate worksurface: <ul style="list-style-type: none"> –Vinyl 3 mm edge profile or plastic P-edge profile on front edge –Plastic default flat profile on side and back edges • Wood worksurface: <ul style="list-style-type: none"> –Wood 3 mm edge profile on front edge –Matching veneer flat profile on side and back edges • Cable scallop on back edge 	<ol style="list-style-type: none"> 1 Style number with appropriate edge profile suffix in the space provided <ul style="list-style-type: none"> P Laminate with vinyl P-edge SW Wood with square edge ▶ See edge profiles below 2 Laminate or wood color number for worksurface 3 Plastic color number for front edge on laminate worksurface, if selected 4 Options, if selected (see below) <ul style="list-style-type: none"> ▶ See <i>Surface Materials</i>, page D102.

Options	Price	Required to Specify
Surface Materials <ul style="list-style-type: none"> • Laminate worksurfaces <ul style="list-style-type: none"> • Accent laminate +\$60 • Open Line laminate +\$60 plus cost of laminate • Wood veneer worksurfaces <ul style="list-style-type: none"> • Customiz stain Prices below • Full-fill finish Prices below 		<ul style="list-style-type: none"> ▶ See <i>Surface Materials Reference Manual</i>. ▶ See <i>Surface Materials Reference Manual</i>. Specify with <i>Customiz stain</i>. ▶ See <i>Surface Materials Reference Manual</i>. Specify full-fill finish number.
Scallops <ul style="list-style-type: none"> • Omit scallop 	No cost	Specify <i>omit scallop</i> .
Related Products <ul style="list-style-type: none"> • Panel-mounted Universal Systems worksurface supports • Legs and supports for Universal Systems Worksurfaces • Adjustable column • Worksurface screens • Worksurface power and communication components 		<ul style="list-style-type: none"> ▶ Page D38 ▶ Page D45 ▶ Page D45 ▶ Page D77 ▶ Page D81

Specification Information

Planning Dimensions A B C D	Style Number	Base Prices		Wood Square Edge Suffix SW	Options (Add \$ to Base Price)
		Laminate	Wood		
		Vinyl 3 mm Edge No Suffix	Vinyl P-Edge Suffix P		Customiz : Full-Fill Stain on : Finish Wood

Left-Hand Worksurfaces

30"	24"	66"	48"	UJC3268L__	\$699	\$799	\$ 969	+\$68	+\$68
30"	24"	72"	48"	UJC3228L__	\$724	\$824	\$1004	+\$70	+\$70
30"	24"	78"	48"	UJC3288L__	\$747	\$847	\$1037	+\$74	+\$74
30"	30"	66"	48"	UJC3368L__	\$722	\$822	\$ 992	+\$68	+\$68
30"	30"	72"	48"	UJC3328L__	\$747	\$847	\$1027	+\$70	+\$70
30"	30"	78"	48"	UJC3388L__	\$772	\$872	\$1062	+\$74	+\$74

Right-Hand Worksurfaces

24"	30"	48"	66"	UJC2386R__	\$699	\$799	\$ 969	+\$68	+\$68
24"	30"	48"	72"	UJC2382R__	\$724	\$824	\$1004	+\$70	+\$70
24"	30"	48"	78"	UJC2388R__	\$747	\$847	\$1037	+\$74	+\$74
30"	30"	48"	66"	UJC3386R__	\$722	\$822	\$ 992	+\$68	+\$68
30"	30"	48"	72"	UJC3382R__	\$747	\$847	\$1027	+\$70	+\$70
30"	30"	48"	78"	UJC3388R__	\$772	\$872	\$1062	+\$74	+\$74

Bubble Jetty Worksurfaces

Laminate or Wood Veneer

SIN 711.1



Tip: Illustration above shows a left-hand worksurface.

Tip: Supports for freestanding and panel-mounted applications must be specified separately.

Tip: P-edge profile and wood veneer bubble jetty worksurfaces include alignment slots to accept two cabby legs or two elliptical legs for support in panel-mounted applications.

Tip: To specify 3 mm edge profile, no suffix is required. For all other edge profiles, add a suffix to the style number (for example, US1830_ becomes US1830SW for wood with square edge profile).

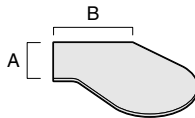
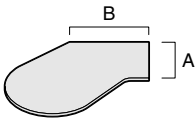

Standard Includes

- Worksurface: laminate or wood veneer
- Laminate worksurface:
 - Vinyl 3 mm edge profile or plastic P-edge profile on front edge
 - Plastic default flat profile on side and back edges
- Wood worksurface:
 - Wood 3 mm edge profile on front edge
 - Matching veneer flat profile on side and back edges

Required to Specify

- 1 Style number with appropriate edge profile suffix in the space provided
 - P** Laminate with vinyl P-edge
 - SW** Wood with square edge
 - 2 Laminate color number for worksurface
 - 3 Plastic color number for front edge
 - 4 Options, if selected (see below)
- ▶ See *Surface Materials*, page D102.

Options

Surface Materials	Laminate worksurfaces	U.S. Price	Required to Specify
	• Accent laminate	+\$60	▶ See <i>Surface Materials Reference Manual</i> .
	• Open Line laminate	+\$60 plus cost of laminate	▶ See <i>Surface Materials Reference Manual</i> .
	Wood veneer worksurfaces		
	• Customiz stain	Prices below	Specify with <i>Customiz</i> stain. ▶ See <i>Surface Materials Reference Manual</i> .
	• Full-fill finish	Prices below	Specify full-fill finish number.
Related Products	• Panel-mounted Universal Systems worksurface supports		▶ Page D38
	• Legs and supports for Universal Systems Worksurfaces		▶ Page D45
	• Adjustable column		▶ Page D45
	• Worksurface power and communication components		▶ Page D81

Specification Information

Planning Dimensions A B	Style Number	U.S. Base Prices		Wood Square Edge Suffix SW	Options (Add \$ to Base Price) Customiz : Full-Fill Stain on : Finish Wood :
		Laminate Vinyl 3 mm Edge No Suffix	Wood Vinyl P-Edge Suffix P		

Left-Hand Worksurfaces

24"	30"	UJBC2430L_	\$655	\$745	\$ 925	+\$35	+\$35
24"	36"	UJBC2436L_	\$695	\$785	\$ 965	+\$37	+\$37
24"	42"	UJBC2442L_	\$735	\$825	\$1005	+\$41	+\$41
24"	48"	UJBC2448L_	\$775	\$865	\$1045	+\$47	+\$47
:	:	:	:	:	:	:	:

Right-Hand Worksurfaces

24"	30"	UJBC2430R_	\$655	\$745	\$ 925	+\$35	+\$35
24"	36"	UJBC2436R_	\$695	\$785	\$ 965	+\$37	+\$37
24"	42"	UJBC2442R_	\$735	\$825	\$1005	+\$41	+\$41
24"	48"	UJBC2448R_	\$775	\$865	\$1045	+\$47	+\$47
:	:	:	:	:	:	:	:

Visitor and Linking, Straight-Front Worksurfaces

Laminate or Wood Veneer

SIN 711.1

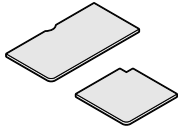

Tip: Supports for freestanding and panel-mounted applications must be specified separately.

Tip: P-edge profile and wood veneer visitor and linking, straight-front worksurfaces include alignment slots to accept one cabby leg or one elliptical leg for column support in panel-mounted applications.

Tip: Visitor and linking, straight-front worksurfaces are recommended for use with other straight-front shapes such as corner, straight-front worksurfaces.

▶ Page D6



Tip: Scallops are available only on visitor worksurfaces 36"W and wider.

Standard Includes	Required to Specify
<ul style="list-style-type: none"> • Worksurface: laminate or wood veneer • Laminate worksurface: <ul style="list-style-type: none"> –Vinyl 3 mm edge profile or plastic P-edge profile on front edge –Plastic default flat profile on side and back edges • Wood worksurface: <ul style="list-style-type: none"> –Wood 3 mm edge profile on front edge –Matching veneer flat profile on side and back edges • Cable scallop on back edge of visitor worksurfaces 36"W and wider 	<ol style="list-style-type: none"> 1 Style number with appropriate edge profile suffix in the space provided <ul style="list-style-type: none"> P Laminate with vinyl P-edge SW Wood with square edge ▶ See edge profiles at right 2 Laminate or wood color number for worksurface 3 Plastic color number for front edge on laminate worksurface, if selected 4 Options, if selected (see below) <ul style="list-style-type: none"> ▶ See <i>Surface Materials</i>, page D102.

Surface Materials	Options	Price	Required to Specify
	Laminate worksurfaces		▶ See <i>Surface Materials Reference Manual</i> . ▶ See <i>Surface Materials Reference Manual</i> .
	• Accent laminate	+\$60	
	• Open Line laminate	+\$60 plus cost of laminate	
	Wood veneer worksurfaces		Specify with <i>Customiz stain</i> . ▶ See <i>Surface Materials Reference Manual</i> . Specify full-fill finish number.
	• Customiz stain	Prices at right	
	• Full-fill finish	Prices at right	
Scallops	• Omit scallop	No cost	Specify <i>omit scallop</i> .
Related Products	• Panel-mounted Universal Systems worksurface supports		▶ Page D38
	• Legs and supports for Universal Systems Worksurfaces		▶ Page D45

Tip: To specify 3 mm edge profile, no suffix is required. For all other edge profiles, add a suffix to the style number (for example, US1830__ becomes US1830SW for wood with square edge profile).

Specification Information

Planning Dimensions A B	Style Number	Base Prices		Options (Add \$ to Base Price) Customiz : Full-Fill Stain on : Finish Wood
		Laminate	Wood	
		 Vinyl 3 mm Edge No Suffix	 Vinyl P-Edge Suffix P	 Wood Square Edge Suffix SW

Visitor, Straight-Front Worksurfaces

Left-Hand Worksurfaces

24" 24"	UV2424L__	\$353	\$423	\$623	+\$32	+\$32
24" 30"	UV2430L__	\$378	\$448	N.A.	N.A.	N.A.
24" 36"	UV2436L__	\$403	\$543	N.A.	N.A.	N.A.
24" 42"	UV2442L__	\$428	\$638	N.A.	N.A.	N.A.
24" 48"	UV2448L__	\$453	\$733	N.A.	N.A.	N.A.
30" 30"	UV3030L__	\$365	\$435	\$640	+\$32	+\$32
30" 36"	UV3036L__	\$390	\$460	N.A.	N.A.	N.A.
30" 42"	UV3042L__	\$415	\$555	N.A.	N.A.	N.A.
30" 48"	UV3048L__	\$440	\$650	N.A.	N.A.	N.A.

Right-Hand Worksurfaces

24" 24"	UV2424R__	\$353	\$423	\$623	+\$32	+\$32
24" 30"	UV2430R__	\$378	\$448	N.A.	N.A.	N.A.
24" 36"	UV2436R__	\$403	\$543	N.A.	N.A.	N.A.
24" 42"	UV2442R__	\$428	\$638	N.A.	N.A.	N.A.
24" 48"	UV2448R__	\$453	\$733	N.A.	N.A.	N.A.
30" 30"	UV3030R__	\$365	\$435	\$640	+\$32	+\$32
30" 36"	UV3036R__	\$390	\$460	N.A.	N.A.	N.A.
30" 42"	UV3042R__	\$415	\$555	N.A.	N.A.	N.A.
30" 48"	UV3048R__	\$440	\$650	N.A.	N.A.	N.A.

Linking, Straight-Front Worksurfaces

With 2" Notch for Use with Kick Panels

26" 26"	UL2626__	\$442	\$512	\$712	+\$32	+\$32
---------	-----------------	-------	-------	-------	-------	-------

With 3" Notch for Use with Answer Panels and Montage Frames

27" 27"	UL2727__	\$442	\$512	\$712	+\$32	+\$32
---------	-----------------	-------	-------	-------	-------	-------

With 4" Notch for Use with Pathways Technology Wall Panels

28" 28"	UL2828__	\$442	\$512	\$712	+\$32	+\$32
---------	-----------------	-------	-------	-------	-------	-------

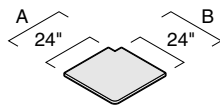
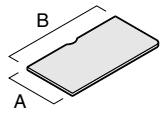
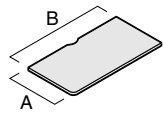

Worksurfaces

Visitor and Linking, Curved-Front Worksurfaces

Laminate or Wood Veneer

SIN 711.1

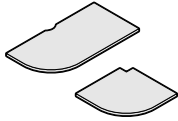

Tip: Supports for freestanding and panel-mounted applications must be specified separately.

Tip: P-edge profile and wood veneer visitor and linking, curved-front worksurfaces include alignment slots to accept one cabby leg or one elliptical leg for column support in panel-mounted applications.

Tip: Visitor and linking, curved-front worksurfaces are recommended for use with other curved-front shapes such as corner, curved-front worksurfaces.
▶ Page D8



Tip: Scallops are available only on visitor worksurfaces 36"W and wider.

Standard Includes	Required to Specify
<ul style="list-style-type: none"> • Worksurface: laminate or wood veneer • Laminate worksurface: <ul style="list-style-type: none"> – Vinyl 3 mm edge profile or plastic P-edge profile on front edge – Plastic default flat profile on side and back edges • Wood worksurface: <ul style="list-style-type: none"> – Wood 3 mm edge profile on front edge – Matching veneer flat profile on side and back edges • Cable scallop on back edge of visitor worksurfaces 36"W and wider 	<ol style="list-style-type: none"> 1 Style number with appropriate edge profile suffix in the space provided <ul style="list-style-type: none"> P Laminate with vinyl P-edge SW Wood with square edge ▶ See edge profiles at right 2 Laminate or wood color number for worksurface 3 Plastic color number for front edge on laminate worksurface, if selected 4 Options, if selected (see below) <ul style="list-style-type: none"> ▶ See <i>Surface Materials</i>, page D102.

Surface Materials	Options	Price	Required to Specify
	Laminate worksurfaces		
	<ul style="list-style-type: none"> • Accent laminate • Open Line laminate 	+\$60 +\$60 plus cost of laminate	<ul style="list-style-type: none"> ▶ See <i>Surface Materials Reference Manual</i>. ▶ See <i>Surface Materials Reference Manual</i>.
	Wood veneer worksurfaces		
	<ul style="list-style-type: none"> • Customiz stain • Full-fill finish 	Prices at right Prices at right	<ul style="list-style-type: none"> Specify with <i>Customiz stain</i>. ▶ See <i>Surface Materials Reference Manual</i>. Specify full-fill finish number.
Scallops	<ul style="list-style-type: none"> • Omit scallop 	No cost	Specify <i>omit scallop</i> .
Related Products	<ul style="list-style-type: none"> • Panel-mounted Universal Systems worksurface supports • Legs and supports for Universal Systems Worksurfaces 		<ul style="list-style-type: none"> ▶ Page D38 ▶ Page D45

Tip: To specify 3 mm edge profile, no suffix is required. For all other edge profiles, add a suffix to the style number (for example, US1830_ becomes US1830SW for wood with square edge profile).

Specification Information

Planning Dimensions A B	Style Number	Base Prices		Options (Add \$ to Base Price) Customiz : Full-Fill Stain on : Finish Wood
		Vinyl 3 mm Edge No Suffix	Vinyl P-Edge Suffix P	
				
				
				Wood Square Edge Suffix SW

Visitor, Curved-Front Worksurfaces

Left-Hand Worksurfaces

24" 24"	UVC2424L_	\$353	\$423	\$623	+\$32	+\$32
24" 30"	UVC2430L_	\$378	\$448	N.A.	N.A.	N.A.
24" 36"	UVC2436L_	\$403	\$543	N.A.	N.A.	N.A.
24" 42"	UVC2442L_	\$428	\$638	N.A.	N.A.	N.A.
24" 48"	UVC2448L_	\$453	\$733	N.A.	N.A.	N.A.
30" 30"	UVC3030L_	\$365	\$435	\$640	+\$32	+\$32
30" 36"	UVC3036L_	\$390	\$460	N.A.	N.A.	N.A.
30" 42"	UVC3042L_	\$415	\$555	N.A.	N.A.	N.A.
30" 48"	UVC3048L_	\$440	\$650	N.A.	N.A.	N.A.

Right-Hand Worksurfaces

24" 24"	UVC2424R_	\$353	\$423	\$623	+\$32	+\$32
24" 30"	UVC2430R_	\$378	\$448	N.A.	N.A.	N.A.
24" 36"	UVC2436R_	\$403	\$543	N.A.	N.A.	N.A.
24" 42"	UVC2442R_	\$428	\$638	N.A.	N.A.	N.A.
24" 48"	UVC2448R_	\$453	\$733	N.A.	N.A.	N.A.
30" 30"	UVC3030R_	\$365	\$435	\$640	+\$32	+\$32
30" 36"	UVC3036R_	\$390	\$460	N.A.	N.A.	N.A.
30" 42"	UVC3042R_	\$415	\$555	N.A.	N.A.	N.A.
30" 48"	UVC3048R_	\$440	\$650	N.A.	N.A.	N.A.

Linking, Curved-Front Worksurfaces

With 2" Notch for Use with Kick Panels

26" 26"	ULC2626_	\$442	\$512	\$712	+\$32	+\$32
---------	-----------------	-------	-------	-------	-------	-------

With 3" Notch for Use with Answer Panels and Montage Frames

27" 27"	ULC2727_	\$442	\$512	\$712	+\$32	+\$32
---------	-----------------	-------	-------	-------	-------	-------

With 4" Notch for Use with Pathways Technology Wall Panels

28" 28"	ULC2828_	\$442	\$512	\$712	+\$32	+\$32
---------	-----------------	-------	-------	-------	-------	-------

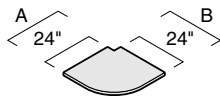
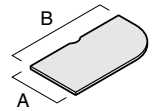
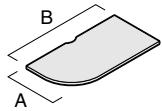

Transaction Worksurfaces

Laminate or Wood Veneer

SIN 711.1

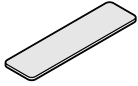

Standard Includes	Required to Specify
<ul style="list-style-type: none"> • Worksurface: laminate or wood veneer • Laminate worksurface: <ul style="list-style-type: none"> – Vinyl 3 mm edge profile or plastic P-edge profile on all edges • Wood worksurface: <ul style="list-style-type: none"> – Wood 3 mm edge profile on all edges • Top caps for use with Answer panels, if selected: paint • Support brackets: black paint only 	<ol style="list-style-type: none"> 1 Style number with appropriate edge profile suffix in the space provided <ul style="list-style-type: none"> P Laminate with vinyl P-edge SW Wood with square edge <ul style="list-style-type: none"> ▶ See edge profiles at right 2 Laminate or wood color number for worksurface 3 Plastic color number for edges on laminate worksurface, if selected 4 Paint color number for top caps, if selected 5 Options, if selected (see below) <ul style="list-style-type: none"> ▶ See <i>Surface Materials</i>, page D102.

Surface Materials	Options	Price	Required to Specify
	Laminate worksurfaces		
	• Accent laminate	+\$60	▶ See <i>Surface Materials Reference Manual</i> .
	• Open Line laminate	+\$60 plus cost of laminate	▶ See <i>Surface Materials Reference Manual</i> .
	Wood veneer worksurfaces		
	• Customiz stain	Prices at right	Specify <i>with Customiz stain</i> . ▶ See <i>Surface Materials Reference Manual</i> .
	• Full-fill finish	Prices at right	Specify full-fill finish number.
Top caps on laminate worksurfaces for use with Answer panels			
• Wood		+\$88	Specify <i>with wood top cap</i> and select wood color number.
• Customiz stain on wood		No cost	Specify <i>with Customiz stain</i> .

Specification Information

Tip: To specify 3 mm edge profile, no suffix is required. For all other edge profiles, add a suffix to the style number (for example, US1830_ becomes US1830SW for wood with square edge profile).

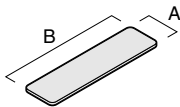

Tip: Actual width of Answer transaction work surface is 7" shorter than the nominal planning dimension to accommodate change of panel height applications.

Planning Dimensions A B	Style Number	Base Prices		Wood Square Edge Suffix SW	Options (Add \$ to Base Price) Customiz : Full-Fill Stain on : Finish Wood
		Vinyl 3 mm Edge No Suffix	Vinyl P-Edge Suffix P		

With Brackets for Use with Kick Panels

16"	30"	UTR1630K_	\$270	\$305	N.A.	N.A.	N.A.
16"	36"	UTR1636K_	\$292	\$332	\$562	+\$41	+\$41
16"	42"	UTR1642K_	\$314	\$354	\$584	+\$41	+\$41
16"	48"	UTR1648K_	\$335	\$385	\$605	+\$41	+\$41
16"	60"	UTR1660K_	\$362	\$412	\$662	+\$60	+\$60

With Brackets and Top Caps for Use with Answer Panels

16"	30"	UTR1630A_	\$270	\$305	N.A.	N.A.	N.A.
16"	36"	UTR1636A_	\$292	\$332	\$562	+\$41	+\$41
16"	42"	UTR1642A_	\$314	\$354	\$584	+\$41	+\$41
16"	48"	UTR1648A_	\$335	\$385	\$605	+\$41	+\$41
16"	60"	UTR1660A_	\$362	\$412	\$662	+\$60	+\$60

With Brackets for Use with Montage Frames

16"	30"	UTR1630M_	\$270	\$305	N.A.	N.A.	N.A.
16"	36"	UTR1636M_	\$292	\$332	\$562	+\$41	+\$41
16"	42"	UTR1642M_	\$314	\$354	\$584	+\$41	+\$41
16"	48"	UTR1648M_	\$335	\$385	\$605	+\$41	+\$41
16"	60"	UTR1660M_	\$362	\$412	\$662	+\$60	+\$60

With Brackets for Use with Pathways Technology Wall Panels

16"	30"	UTR1630P_	\$270	\$305	N.A.	N.A.	N.A.
16"	36"	UTR1636P_	\$292	\$332	\$562	+\$41	+\$41
16"	42"	UTR1642P_	\$314	\$354	\$584	+\$41	+\$41
16"	48"	UTR1648P_	\$335	\$385	\$605	+\$41	+\$41
16"	60"	UTR1660P_	\$362	\$412	\$662	+\$60	+\$60

Adjustable-Height Worksurfaces

Laminate, with Crank
SIN 711.1

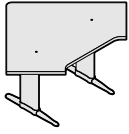

Tip: Adjustable-height work-surfaces are available in laminate only.

Tip: Adjustable-height mechanism requires assembly and attachment to the work surface.

Tip: 48"W dual corner and bi-level corner worksurfaces can support both a keyboard and a mouse pad on the same surface.

Tip: To specify 3 mm edge profile, no suffix is required. For all other edge profiles, add a suffix to the style number (for example, US1830_ becomes US1830SW for wood with square edge profile).

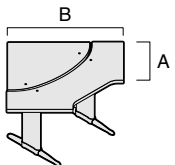
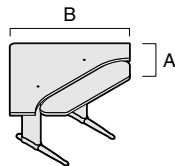
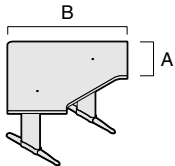

Standard Includes

- Worksurface: laminate
- Vinyl 3 mm edge profile or P-edge profile on front edge of worksurface: plastic
- Flat profile on side and back edges of worksurface: plastic default
- Vinyl 3 mm edge profile or P-edge profile on all sides of keyboard shelf: plastic
- Adjustable-height mechanism
- Leg shrouds and feet: paint price group 1
- Crank handle
- Attachment hardware

Required to Specify

- 1 Style number with appropriate edge profile suffix in the space provided
 - ▶ Laminate with vinyl P-edge
- ▶ See edge profiles below
- 2 Laminate color number for worksurface
- 3 Plastic color number for edges
- 4 Paint color number for leg shrouds and feet
- 5 Options, if selected (see below)
 - ▶ See *Surface Materials*, page D102.

Options

Options	Price	Required to Specify
Surface Materials	<ul style="list-style-type: none"> • Paint price group 1: No cost • Paint price group 2: +\$34 • Paint price group 3: +\$58 	Specify paint color number. Specify paint color number. Specify paint color number.
<ul style="list-style-type: none"> • Accent laminate: +\$60 • Open Line laminate: +\$60 plus cost of laminate 		<ul style="list-style-type: none"> ▶ See <i>Surface Materials Reference Manual</i>. ▶ See <i>Surface Materials Reference Manual</i>.

Specification Information

Base Prices Laminate



Planning Dimensions A B	Style Number	Vinyl 3 mm Edge	Vinyl P-Edge
		No Suffix	Suffix P

Corner Worksurfaces

24" 42"	UCKSC42_	\$1583	\$1633
24" 48"	UCKSC48_	\$1628	\$1678

Dual Corner Worksurfaces

24" 42"	UCKDC42_	\$2183	\$2263
24" 48"	UCKDC48_	\$2228	\$2308

Bi-Level Corner Worksurfaces

24" 42"	UCKBC42_	\$2183	\$2263
24" 48"	UCKBC48_	\$2228	\$2308

▶ **Specification Information, continued on next page**

► Specification Information, continued from previous page

Tip: To specify 3 mm edge profile, no suffix is required. For all other edge profiles, add a suffix to the style number (for example, US1830__ becomes US1830SW for wood with square edge profile).

Specification Information

Planning Dimensions A B	Style Number	Base Prices Laminate	
		Vinyl 3 mm Edge No Suffix	Vinyl P-Edge Suffix P

**Base Prices
Laminate**

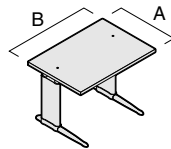

Straight Worksurfaces

30"	42"	UCKSS42__	\$1493	\$1518
30"	48"	UCKSS48__	\$1542	\$1567

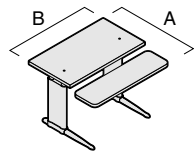

Dual Straight Worksurfaces

36"	42"	UCKDS42__	\$2093	\$2133
36"	48"	UCKDS48__	\$2142	\$2182

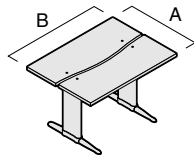

Bi-Level Straight Worksurfaces

36"	42"	UCKBS42__	\$2093	\$2133
36"	48"	UCKBS48__	\$2142	\$2182

Tip: Gas cylinder package can be field-installed to single and dual crank-adjustable worksurfaces to provide additional lift.

Pair of Gas Cylinders

		UGC	\$ 150	N.A.
--	--	------------	--------	------

Adjustable-Height Extension Link Worksurfaces

Laminate, with Crank

SIN 711.1

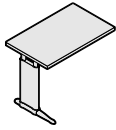

Tip: Adjustable-height extension link worksurfaces are available in laminate only.

Tip: Extension-link worksurfaces may be attached to corner or bi-level worksurfaces only. They cannot be attached to dual worksurfaces.

Tip: Adjustable-height mechanism requires assembly and attachment to the worksurface.

Tip: To specify 3 mm edge profile, no suffix is required. For all other edge profiles, add a suffix to the style number (for example, US1830__ becomes US1830SW for wood with square edge profile).

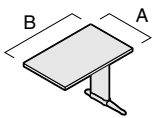
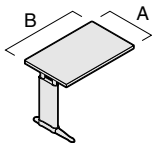



Standard Includes	Required to Specify
-------------------	---------------------

- Worksurface: laminate
- Vinyl 3 mm edge profile or P-edge profile on front edge: plastic
- Flat profile on side and back edges: plastic default
- Adjustable-height mechanism
- Leg shrouds and feet: paint price group 1
- Gas cylinder
- Attachment hardware

- 1 Style number with appropriate edge profile suffix in the space provided
P Laminate with vinyl P-edge
 ▶ See edge profiles below
- 2 Laminate color number for worksurface
- 3 Plastic color number for front edge
- 4 Paint color number for leg shrouds and feet
- 5 Options, if selected (see below)
 ▶ See *Surface Materials*, page D102.

Surface Materials	Options	Price	Required to Specify
	<ul style="list-style-type: none"> • Paint price group 1 • Paint price group 2 • Paint price group 3 	No cost +\$17 +\$29	Specify paint color number. Specify paint color number. Specify paint color number.
	<ul style="list-style-type: none"> • Accent laminate • Open Line laminate 	+\$60 +\$60 plus cost of laminate	▶ See <i>Surface Materials Reference Manual</i> . ▶ See <i>Surface Materials Reference Manual</i> .

Specification Information

• Planning Dimensions A B	• Style Number	Base Prices Laminate	
		• Vinyl 3 mm Edge No Suffix	• Vinyl P-Edge Suffix P
			

Left-Hand Worksurfaces

24"	24"	UCKEL24__	\$1230	\$1255
24"	36"	UCKEL36__	\$1341	\$1366
:	:	:	:	:

Right-Hand Worksurfaces

24"	24"	UCKER24__	\$1230	\$1255
24"	36"	UCKER36__	\$1341	\$1366
:	:	:	:	:

Adjustable-Height
Extension Link
Worksurfaces, with Crank

SIN 711.1

Adjustable-Height Worksurfaces

Laminate, with Electrically Adjustable Column Support

SIN 711.1

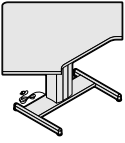

Tip: Adjustable-height work-surfaces are available in laminate only.

Tip: Adjustable-height mechanism requires assembly and attachment to the worksurface.

Tip: 48"W dual corner work-surfaces can support both a keyboard and a mouse pad on the same surface.

Standard Includes		Required to Specify	
<ul style="list-style-type: none"> • Worksurface with 150 lb weight capacity: laminate • Vinyl 3 mm edge profile or P-edge profile on front edge of worksurface: plastic • Flat profile on side and back edges of worksurface: plastic default • Vinyl 3 mm edge profile or P-edge profile on all sides of keyboard shelf: plastic • Drawer-mounted two-button controller • Adjustable-height column mechanism and base: paint price group 1 • 9' power cord: black vinyl only • Attachment hardware 		<ol style="list-style-type: none"> 1 Style number with appropriate edge profile suffix in the space provided <ul style="list-style-type: none"> ▶ Laminate with vinyl P-edge ▶ See edge profiles at right 2 Laminate color number for worksurface 3 Plastic color number for front edge 4 Paint color number for column and base 5 Options, if selected (see below) <ul style="list-style-type: none"> ▶ See <i>Surface Materials</i>, page D102. 	
Options	Price	Required to Specify	
Surface Materials	• Paint price group 1	No cost	Specify paint color number.
	• Paint price group 2	+\$ 34	Specify paint color number.
	• Paint price group 3	+\$ 58	Specify paint color number.
	• Accent laminate	+\$ 60	▶ See <i>Surface Materials Reference Manual</i> .
	• Open Line laminate	+\$ 60 plus cost of laminate	▶ See <i>Surface Materials Reference Manual</i> .
Programmable Memory	• Drawer-mounted six-button controller with 3x3 programmable memory and soft-start/soft-stop	+\$299	Specify <i>with SSM</i> .
High-Performance Adjustable-Height Worksurface with Programmable Memory	• 250 pound weight capacity and drawer-mounted six-button controller with 3x3 programmable memory and soft-start/soft-stop	+\$699	Specify <i>with 250SSM</i> .

Tip: To specify 3 mm edge profile, no suffix is required. For all other edge profiles, add a suffix to the style number (for example, US1830__ becomes US1830SW for wood with square edge profile).

Specification Information

• Planning Dimensions A B	• Style Number	• Base Prices Laminate	
		• Vinyl 3 mm Edge No Suffix	• Vinyl P-Edge Suffix P

**Base Prices
Laminate**

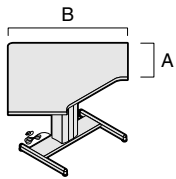

Corner Worksurfaces

24"	42"	UECSC42__	\$1943	\$1993
24"	48"	UECSC48__	\$1989	\$2039

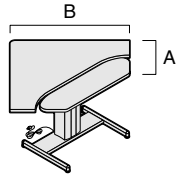

Dual Corner Worksurfaces

24"	42"	UECDC42__	\$2543	\$2623
24"	48"	UECDC48__	\$2589	\$2669

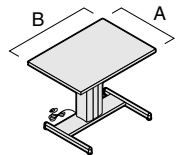

Straight Worksurfaces

30"	42"	UECSS42__	\$1853	\$1878
30"	48"	UECSS48__	\$1902	\$1927

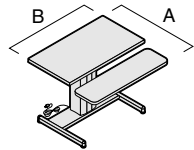

Dual Straight Worksurfaces

36"	42"	UECDS42__	\$2453	\$2493
36"	48"	UECDS48__	\$2502	\$2542

Panel-Mounted Worksurface Supports

for Use with Answer, Kick, and Pathways Technology Wall Panels

SIN 711.1

Cantilevers

Standard Includes	Required to Specify
<ul style="list-style-type: none"> • Cantilever: paint • Tie plate • Attachment hardware 	Style number

Specification Information

• Style Number	• Price

On-Module Cantilever

UCANT	\$ 50
--------------	-------

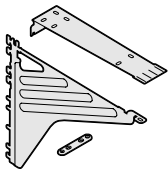

Tip: Answer panel junctions can accommodate only one cantilever at a seam.

Tip: 30"D straight and transition cantilevered worksurfaces require additional floor support along the front edge, such as a pedestal, end panel, post leg, side support bracket, or an adjacent return worksurface.

Off-Module Cantilever (For Pathways Technology Wall Panel only)

UCANTOM	\$116
----------------	-------

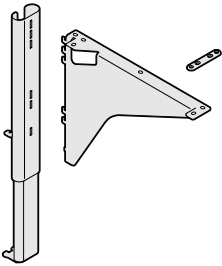

Tip: Pathways Technology Wall panel must be specified with a functional off-module rail and a segmented skin 12" above base.

Tip: 30"D straight and transition cantilevered worksurfaces require additional floor support along the front edge, such as a pedestal, end panel, post leg, side support bracket, or an adjacent return worksurface.

Side-Support Bracket



Tip: Side-support bracket includes a pair of handed brackets, only one of which is required for rear corner support of panel-mounted corner worksurfaces. Specify one for every two corner worksurfaces in on-module applications. Order an additional supply for off-module fin wall applications.

Standard Includes	Required to Specify
<ul style="list-style-type: none"> • Pair of handed side-support brackets: black paint only • Attachment hardware 	Style number

Specification Information

• Style Number	• Price
USSBR	\$13

Support Plates

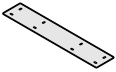

Tip: Support plate can also be used in freestanding and Montage applications.

Standard Includes	Required to Specify
<ul style="list-style-type: none"> • Support plate: black paint only • Attachment hardware 	Style number

Specification Information

• Dimensions	• Style Number	• Price
14"D	TS714WSP	\$32
20"D	TS720WSP	\$32

Tie Plates



Standard Includes	Required to Specify
<ul style="list-style-type: none"> • Package of six tie plates: black paint only • Attachment hardware 	Style number

Specification Information

• Dimensions	• Style Number	• Price
3 ³ / ₄ "L	TS7TIEPLATE	\$46

Worksurfaces

Panel-Mounted Worksurface Supports, continued
for Use With Answer, Kick, and Pathways Technology Wall Panels
SIN 711.1

Reinforcing Channel

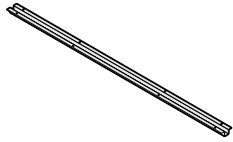

Tip: Reinforcing channel is recommended to add support to worksurfaces that have 60" or more of unsupported kneespace.

Tip: Reinforcing channel can also be used in freestanding or Montage applications.

Standard Includes	Required to Specify
-------------------	---------------------

- Reinforcing channel: black paint only
- Attachment hardware

Style number

Specification Information		
Dimensions	Style Number	Price

Dimensions	Style Number	Price
57"W	TS7WKSPT	\$24

Center Support Panels

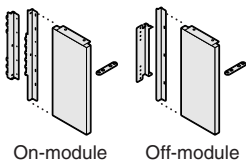

Standard Includes	Required to Specify
-------------------	---------------------

- Center support panel: paint price group 1
- Tie plate
- Attachment hardware

- 1 Style number
 - 2 Paint color number for center support panel
 - 3 Options, if selected (see below)
- ▶ See *Surface Materials*, page D102.

Options	Price	Required to Specify
---------	-------	---------------------

Options	Price	Required to Specify	
Surface Materials	<ul style="list-style-type: none"> • Paint price group 1 • Paint price group 2 • Paint price group 3 	<ul style="list-style-type: none"> No cost +\$12 +\$18 	<ul style="list-style-type: none"> Specify paint color number. Specify paint color number. Specify paint color number.

Specification Information		
Planning Dimensions	Style Number	Base Price

Planning Dimensions	Style Number	Base Price
---------------------	--------------	------------

On-Module Center Support Panel

11"	28½"	UCSP	\$115
-----	------	-------------	-------

Standing Height

11"	41½"	UCSPS	\$130
-----	------	--------------	-------

Off-Module Center Support Panel (For Pathways Technology Wall Panel only)

11"	28½"	UCSPOM	\$115
-----	------	---------------	-------

Standing Height

11"	41½"	UCSPSOM	\$130
-----	------	----------------	-------

End Panels

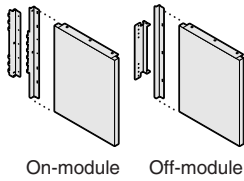

Standard Includes	Required to Specify
<ul style="list-style-type: none"> • End panel: paint price group 1 • Attachment hardware 	<ul style="list-style-type: none"> 1 Style number 2 Paint color number for end panel 3 Options, if selected (see below) ▶ See <i>Surface Materials</i>, page D102.

Options	Price	Required to Specify
Surface Materials <ul style="list-style-type: none"> • Paint price group 1 • Paint price group 2 • Paint price group 3 	<ul style="list-style-type: none"> No cost +\$25 +\$43 	<ul style="list-style-type: none"> Specify paint color number. Specify paint color number. Specify paint color number.

Specification Information

Planning Dimensions	Style Number	Base Price
D H		

On-Module End Panel

24"	28½"	UEP24	\$203
30"	28½"	UEP30	\$230

Standing Height

24"	41½"	UEP24S	\$239
30"	41½"	UEP30S	\$270

Off-Module End Panel (For Pathways Technology Wall Panel only)

24"	28½"	UEP24OM	\$203
30"	28½"	UEP30OM	\$230

Standing Height

24"	41½"	UEP24SOM	\$239
30"	41½"	UEP30SOM	\$270

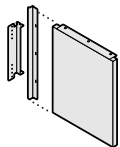
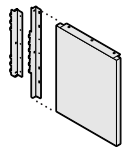

Panel-Mounted Worksurface Supports

for Use with Montage Frames

SIN 711.1

Cantilevers

Tip: All cantilevers work in on-module vertical upright situations only.

Standard Includes	Required to Specify
<ul style="list-style-type: none"> • Cantilever: paint • Attachment hardware 	<ul style="list-style-type: none"> 1 Style number 2 Paint color number for cantilevers ▶ See <i>Surface Materials</i>, page D102.

Specification Information

• Style Number	• Price

On-Module Cantilevers

Non-Handed Cantilever

ZCB \$ 37

Shared Cantilever

ZCSB \$ 49

End-of-Run Cantilevers

Left-Hand End-of-Run Cantilever

ZCEL \$ 49

Right-Hand End-of-Run Cantilever

ZCER \$ 49

Adjustable-Height Cantilevers

Left-Hand Adjustable-Height Cantilever

ZCAL \$158

Right-Hand Adjustable-Height Cantilever

ZCAR \$158

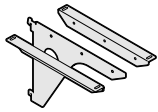
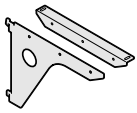

Tip: Shared cantilevers can support bubble visitor, jetty, bubble jetty, and visitor worksurfaces.

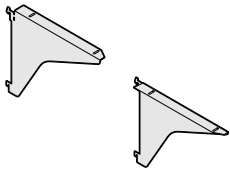

Tip: End-of-run cantilevers are used at the end of a corner worksurface.

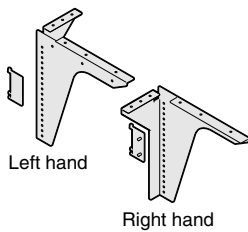

Tip: Adjustable-height cantilevers require a third cantilever to support rear of corner worksurface.

Side-Support Bracket

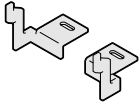

Tip: Side-support bracket includes a pair of handed brackets, only one of which is required for rear corner support of panel-mounted corner worksurfaces. Specify one for every two corner worksurfaces in on-module applications. Order an additional supply for off-module fin wall applications.

Standard Includes	Required to Specify
<ul style="list-style-type: none"> • Pair of handed side-support brackets: black paint only • Attachment hardware 	Style number

Specification Information

Style Number	Price
ZBES	\$25

Off-Module Worksurface Bracket



Tip: Brackets are used in off-module situations only.

Tip: Off-module brackets must be used in conjunction with on-module cantilevers to provide forward worksurface tip support.

Standard Includes	Required to Specify
<ul style="list-style-type: none"> • Off-module worksurface bracket: paint • Attachment hardware 	1 Style number 2 Paint color number for off-module worksurface bracket ▶ See <i>Surface Materials</i> , page D102.

Specification Information

Style Number	Price
ZBWOM	\$25

Off-Module Tie Plate



Tip: Tie plate is used in conjunction with an off-module worksurface bracket.

Tip: Support plate and reinforcing channel can also be used.

▶ Pages D39, D40

Standard Includes	Required to Specify
<ul style="list-style-type: none"> • Package of five tie plates: black paint only • Attachment hardware 	Style number

Specification Information

Style Number	Price
ZBTP	\$20

Panel-Mounted Worksurface Supports for Use with Montage Frames, continued

SIN 711.1

End Panels

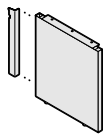
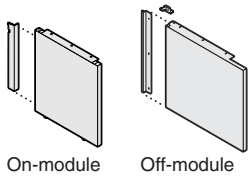

Tip: On-module end panels work in on-module vertical upright situations only.

Tip: On-module end panels can be converted to off-module end panels by ordering a panel package from Service Parts.

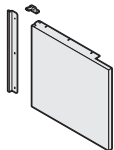

Tip: Off-module end panels work in off-module situations only.

Tip: Off-module end panels can be converted to on-module end panels by ordering a panel package from Service Parts.

Standard Includes	Required to Specify
<ul style="list-style-type: none"> • End panel: paint price group 1 • Attachment hardware 	<ul style="list-style-type: none"> 1 Style number 2 Paint color number for end panel 3 Options, if selected (see below) ▶ See <i>Surface Materials</i>, page D102.

Options	Price	Required to Specify
Surface Materials <ul style="list-style-type: none"> • Paint price group 1 • Paint price group 2 • Paint price group 3 	No cost +\$17 +\$29	Specify paint color number. Specify paint color number. Specify paint color number.

Specification Information

Planning Dimensions	Style Number	Base Price
D H		

On-Module End Panel

Left-Hand

24"	28½"	ZEP24LH	\$165
30"	28½"	ZEP30LH	\$176

Right-Hand

24"	28½"	ZEP24RH	\$165
30"	28½"	ZEP30RH	\$176

Off-Module End Panel

Left-Hand

24"	28½"	ZEP24LHOM	\$165
30"	28½"	ZEP30LHOM	\$176

Right-Hand

24"	28½"	ZEP24RHOM	\$165
30"	28½"	ZEP30RHOM	\$176

Legs and Supports for Universal Systems Worksurfaces

without Alignment Tab
SIN 711.1

Legs and Supports for
Universal Systems
Worksurfaces

Tip: For leg and support guidelines refer to the Leg Matrix.

▶ See Unison Specification Guide.

Tip: Height dimensions listed are nominal and include the thickness of a worksurface.

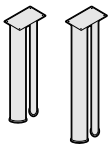
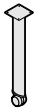
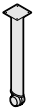
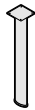
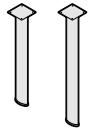

Tip: Double post legs can be used as a shared or column support in applications with other post legs.

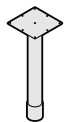
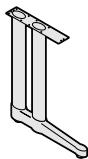

Tip: Adjustable column has a different aesthetic than post legs (round vs. elliptical). Adjustable column can be used as column support in applications without post legs.

Standard Includes	Required to Specify
-------------------	---------------------

- Legs and column: paint
- Attachment hardware
- Caster, if selected: black plastic only

- 1 Style number
- 2 Paint color number for leg or column
- ▶ See *Surface Materials*, page D102.

Specification Information		
Planning Height	Style Number	Price

Single Post Legs

28½"	TS7SPL	\$ 62
------	---------------	-------

Standing Height

41½"	TS7SPLS	\$ 73
------	----------------	-------

Nesting Post Leg

26"	TS7NPL	\$ 57
-----	---------------	-------

Single Post Leg with Caster

28½"	TS7SPLC	\$ 74
------	----------------	-------

Nesting Post Leg with Caster

26"	TS7NPLC	\$ 68
-----	----------------	-------

Double Post Legs

28½"	TS7DPL	\$164
------	---------------	-------

Standing Height

41½"	TS7DPLS	\$193
------	----------------	-------

Double Post C-Leg

28½"	TS7CL	\$195
------	--------------	-------

Adjustable Column

28½"	ZAP	\$133
------	------------	-------

Worksurfaces



Specifying Freestanding Worksurfaces

Worksurfaces

Straight Worksurfaces (SIN 711.1)	D48
Transition Worksurfaces (SIN 711.1)	D50
Corner, Straight-Front Worksurfaces (SIN 711.1)	D52
Corner, Curved-Front Worksurfaces (SIN 711.1)	D53
30" Radius Corner, Straight-Front Worksurfaces (SIN 711.1)	D54
30" Radius Corner, Curved-Front Worksurfaces (SIN 711.1)	D55
Extended Corner, Straight-Front Worksurfaces (SIN 711.1)	D56
Corner, 120° Worksurfaces (SIN 711.1)	D58
Capsule Worksurfaces (SIN 711.1)	D59
Spanner Worksurfaces (SIN 711.1)	D60
Peninsula Worksurfaces (SIN 711.1)	D61
Tapered Peninsula Worksurfaces (SIN 711.1)	D62
Bubble Jetty Worksurfaces (SIN 711.1)	D63
Round Worksurfaces (SIN 711.1)	D64
Square Worksurfaces (SIN 711.1)	D65
Rectangle Worksurfaces (SIN 711.1)	D66
Hub Spanner Worksurfaces (SIN 711.1)	D67
Split-Round Worksurfaces (SIN 711.1)	D68
Tethered Capsule Worksurfaces (SIN 711.1)	D69
Adjustable-Height Worksurfaces (SIN 711.1)	D70

Legs and Tether Bracket for Universal Freestanding Worksurfaces	D74
--	------------

Straight Worksurfaces

Laminate or Wood Veneer

SIN 711.1

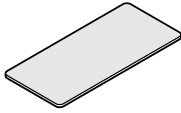

Standard Includes	Required to Specify
-------------------	---------------------

- Worksurface: laminate or wood veneer
- Laminate worksurface: plastic P-edge profile on all sides
- Wood worksurface: wood square 3 mm, wood tapered, or 6000 Black plastic P-edge profile on all sides
- Reinforcing brace for worksurfaces wider than 60"W

- 1 Style number with appropriate edge profile suffix in the space provided
 - P** Laminate with vinyl P-edge
 - V** Wood with vinyl P-edge
 - SW** Wood with square edge
 - BW** Wood with tapered edge
- ▶ See edge profiles at right
- 2 Laminate or wood color number for worksurface
- 3 Plastic color number for P-edge on laminate worksurface, if selected
- 4 Options, if selected (see below)
- ▶ See *Surface Materials*, page D102.

Options	Price	Required to Specify
---------	-------	---------------------

Surface Materials	Laminate worksurfaces	
	<ul style="list-style-type: none"> • Accent laminate +\$60 • Open Line laminate +\$60 plus cost of laminate 	<ul style="list-style-type: none"> ▶ See <i>Surface Materials Reference Manual</i>. ▶ See <i>Surface Materials Reference Manual</i>.
	Wood veneer worksurfaces	
	<ul style="list-style-type: none"> • Customiz stain Prices at right • Full-fill finish Prices at right 	<ul style="list-style-type: none"> Specify with <i>Customiz stain</i>. ▶ See <i>Surface Materials Reference Manual</i>. Specify full-fill finish number.

Related Products	<ul style="list-style-type: none"> • Legs and tether bracket for Universal Freestanding Worksurfaces • Worksurface screens • Worksurface power and communication components • Pathways Post and Beam 	<ul style="list-style-type: none"> ▶ Page D74 ▶ Page D77 ▶ Page D81 ▶ See <i>Pathways Post and Beam</i> chapter.
-------------------------	--	--

Tip: Legs to support free-standing worksurfaces must be specified separately.

Tip: For leg and support guidelines, refer to the Leg Matrix.
▶ See *Unison Specification Guide*.

Tip: Tether brackets to attach to Pathways Post and Beam fence must be specified separately.

Tip: Your specification is not complete until you add a suffix to the style number to define the edge profile (for example, BZC302460_ becomes BZC302460V for wood with vinyl P-edge profile).

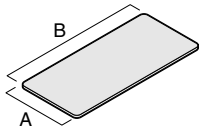

Specification Information

Planning Dimensions A B		Style Number	Base Prices				Options (Add \$ to Base Price) Customiz : Full-Fill Stain on : Finish Wood : Wood	
			Vinyl P-Edge Suffix P	Vinyl P-Edge Suffix V	Wood Square Edge Suffix SW	Wood Tapered Edge Suffix BW		
24"	30"	BFS2430_	\$265	\$445	\$530	\$610	+\$32	+\$32
24"	36"	BFS2436_	\$290	\$470	\$555	\$635	+\$33	+\$33
24"	42"	BFS2442_	\$315	\$525	\$610	\$690	+\$37	+\$37
24"	48"	BFS2448_	\$340	\$550	\$635	\$715	+\$38	+\$38
24"	54"	BFS2454_	\$385	\$575	\$660	\$740	+\$40	+\$40
24"	60"	BFS2460_	\$410	\$630	\$715	\$795	+\$43	+\$43
24"	66"	BFS2466_	\$435	\$655	\$740	\$820	+\$44	+\$44
24"	72"	BFS2472_	\$460	\$680	\$765	\$845	+\$46	+\$46
24"	78"	BFS2478_	\$485	\$705	\$790	\$870	+\$47	+\$47
30"	36"	BFS3036_	\$365	\$495	\$580	\$660	+\$35	+\$35
30"	42"	BFS3042_	\$390	\$550	\$635	\$715	+\$38	+\$38
30"	48"	BFS3048_	\$415	\$575	\$660	\$740	+\$40	+\$40
30"	54"	BFS3054_	\$460	\$600	\$685	\$765	+\$41	+\$41
30"	60"	BFS3060_	\$485	\$655	\$740	\$820	+\$44	+\$44
30"	66"	BFS3066_	\$510	\$680	\$765	\$845	+\$46	+\$46
30"	72"	BFS3072_	\$535	\$705	\$790	\$870	+\$47	+\$47
30"	78"	BFS3078_	\$560	\$730	\$815	\$895	+\$49	+\$49

Worksurfaces

Transition Worksurfaces

Laminate or Wood Veneer

SIN 711.1



Tip: Illustration above shows a left-hand worksurface.

Standard Includes	Required to Specify
<ul style="list-style-type: none"> • Worksurface: laminate or wood veneer • Laminate worksurface: plastic P-edge profile on all sides • Wood worksurface: wood square 3 mm, wood tapered, or 6000 Black plastic P-edge profile on all sides • Reinforcing brace for worksurfaces wider than 60"W 	<p>1 Style number with appropriate edge profile suffix in the space provided</p> <p>P Laminate with vinyl P-edge</p> <p>V Wood with vinyl P-edge</p> <p>SW Wood with square edge</p> <p>BW Wood with tapered edge</p> <p>▶ See edge profiles at right</p> <p>2 Laminate or wood color number for worksurface</p> <p>3 Plastic color number for P-edge on laminate worksurface, if selected</p> <p>4 Options, if selected (see below)</p> <p>▶ See <i>Surface Materials</i>, page D102.</p>

Options	Price	Required to Specify
<p>Surface Materials</p> <p>Laminate worksurfaces</p> <ul style="list-style-type: none"> • Accent laminate +\$60 • Open Line laminate +\$60 plus cost of laminate <hr/> <p>Wood veneer worksurfaces</p> <ul style="list-style-type: none"> • Customiz stain Prices at right • Full-fill finish Prices at right 		<p>▶ See <i>Surface Materials Reference Manual</i>.</p> <p>▶ See <i>Surface Materials Reference Manual</i>.</p> <hr/> <p>Specify with <i>Customiz stain</i>.</p> <p>▶ See <i>Surface Materials Reference Manual</i>. Specify full-fill finish number.</p> <hr/> <p>▶ Page D74</p> <p>▶ Page D77</p> <p>▶ Page D81</p> <p>▶ See <i>Pathways Post and Beam</i> chapter.</p>
<p>Related Products</p> <ul style="list-style-type: none"> • Legs and tether bracket for Universal Freestanding Worksurfaces • Worksurface screens • Worksurface power and communication components • Pathways Post and Beam 		





Tip: Legs to support free-standing worksurfaces must be specified separately.

Tip: For leg and support guidelines, refer to the Leg Matrix.
▶ See *Unison Specification Guide*.

Tip: Tether brackets to attach to Pathways Post and Beam fence must be specified separately.

Tip: Your specification is not complete until you add a suffix to the style number to define the edge profile (for example, BZC302460_ becomes BZC302460V for wood with vinyl P-edge profile).

Specification Information

Planning Dimensions A B C	Style Number	Base Prices				Options (Add \$ to Base Price) Customiz : Full-Fill Stain on : Finish Wood	
		Laminate	Wood	Wood Square Edge	Wood Tapered Edge		
							
		Vinyl P-Edge Suffix P	Vinyl P-Edge Suffix V	Wood Square Edge Suffix SW	Wood Tapered Edge Suffix BW		

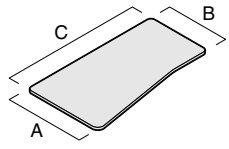

Left-Hand Worksurfaces

30"	24"	60"	BZC302460 _	\$595	\$705	\$790	\$870	+\$47	+\$47
30"	24"	66"	BZC302466 _	\$620	\$730	\$815	\$895	+\$49	+\$49
30"	24"	72"	BZC302472 _	\$645	\$755	\$840	\$920	+\$50	+\$50
30"	24"	78"	BZC302478 _	\$670	\$780	\$865	\$945	+\$52	+\$52
36"	30"	60"	BZC363060 _	\$670	\$755	\$840	\$920	+\$59	+\$59
36"	30"	66"	BZC363066 _	\$695	\$780	\$865	\$945	+\$52	+\$52
36"	30"	72"	BZC363072 _	\$720	\$805	\$890	\$970	+\$53	+\$53
36"	30"	78"	BZC363078 _	\$745	\$830	\$915	\$995	+\$55	+\$55

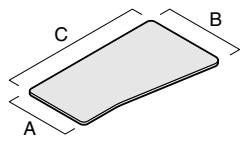

Right-Hand Worksurfaces

24"	30"	60"	BZC243060 _	\$595	\$705	\$790	\$870	+\$47	+\$47
24"	30"	66"	BZC243066 _	\$620	\$730	\$815	\$895	+\$49	+\$49
24"	30"	72"	BZC243072 _	\$645	\$755	\$840	\$920	+\$50	+\$50
24"	30"	78"	BZC243078 _	\$670	\$780	\$865	\$945	+\$52	+\$52
30"	36"	60"	BZC303660 _	\$670	\$755	\$840	\$920	+\$59	+\$59
30"	36"	66"	BZC303666 _	\$695	\$780	\$865	\$945	+\$52	+\$52
30"	36"	72"	BZC303672 _	\$720	\$805	\$890	\$970	+\$53	+\$53
30"	36"	78"	BZC303678 _	\$745	\$830	\$915	\$995	+\$55	+\$55

Worksurfaces

Corner, Straight-Front Worksurfaces

Laminate or Wood Veneer

SIN 711.1



Standard Includes	Required to Specify
-------------------	---------------------

- Worksurface: laminate or wood veneer
- Laminate worksurface: plastic P-edge profile on all sides
- Wood worksurface: wood square 3 mm, wood tapered, or 6000 Black plastic P-edge profile on all sides

- 1 Style number with appropriate edge profile suffix in the space provided
 - P** Laminate with vinyl P-edge
 - V** Wood with vinyl P-edge
 - SW** Wood with square edge
 - BW** Wood with tapered edge
- ▶ See edge profiles below
- 2 Laminate or wood color number for worksurface
- 3 Plastic color number for P-edge on laminate worksurface, if selected
- 4 Options, if selected (see below)
- ▶ See *Surface Materials*, page D102.

Options	Price	Required to Specify
---------	-------	---------------------

Surface Materials	Laminate worksurfaces		
	<ul style="list-style-type: none"> • Accent laminate +\$60 • Open Line laminate +\$60 plus cost of laminate 		<ul style="list-style-type: none"> ▶ See <i>Surface Materials Reference Manual</i>. ▶ See <i>Surface Materials Reference Manual</i>.
	Wood veneer worksurfaces		
	<ul style="list-style-type: none"> • Customiz stain Prices below • Full-fill finish Prices below 		<ul style="list-style-type: none"> Specify with <i>Customiz stain</i>. ▶ See <i>Surface Materials Reference Manual</i>. Specify full-fill finish number.

Related Products	<ul style="list-style-type: none"> • Legs and tether bracket for Universal Freestanding Worksurfaces • Worksurface screens • Worksurface power and communication components • Pathways Post and Beam 	<ul style="list-style-type: none"> ▶ Page D74 ▶ Page D77 ▶ Page D81 ▶ See <i>Pathways Post and Beam</i> chapter.
-------------------------	--	--

Tip: Legs to support free-standing worksurfaces must be specified separately.

Tip: For leg and support guidelines, refer to the Leg Matrix.
▶ See *Unison Specification Guide*.

Tip: Tether brackets to attach to Pathways Post and Beam fence must be specified separately.

Specification Information

Planning Dimensions A B C D				Style Number	Base Prices				Options (Add \$ to Base Price) Customiz Stain on Wood Full-Fill Finish	
					Vinyl P-Edge Suffix P	Vinyl P-Edge Suffix V	Wood Square Edge Suffix SW	Wood Tapered Edge Suffix BW		
24"	24"	42"	42"	BFC224242	\$520	\$720	\$805	\$860	+\$48	+\$48
24"	24"	48"	48"	BFC224848	\$560	\$760	\$845	\$900	+\$50	+\$50
30"	24"	48"	48"	BFC324848	N.A.	\$780	\$865	\$920	+\$49	+\$49
24"	30"	48"	48"	BFC234848	N.A.	\$780	\$865	\$920	+\$49	+\$49
30"	30"	48"	48"	BFC334848	\$600	\$800	\$885	\$940	+\$52	+\$52

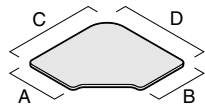

Tip: Your specification is not complete until you add a suffix to the style number to define the edge profile (for example, BZC302460 becomes BZC302460V for wood with vinyl P-edge profile).

Corner, Curved-Front Worksurfaces

Laminate

Corner, Curved-Front Worksurfaces

SIN 711.1



Tip: Corner, curved-front worksurfaces are available in laminate only.

Tip: Legs to support free-standing worksurfaces must be specified separately.

Tip: Tether brackets to attach to Pathways Post and Beam fence must be specified separately.

Standard Includes	Required to Specify
-------------------	---------------------

- Worksurface: laminate
- Vinyl P-edge profile on all sides: plastic

- 1 Style number with appropriate edge profile suffix in the space provided
 - ▶ **P** Laminate with vinyl P-edge
 - ▶ See edge profiles below
- 2 Laminate color number for worksurface
- 3 Plastic color number for edge
- 4 Options, if selected (see below)
- ▶ See *Surface Materials*, page D102.

Options	Price	Required to Specify
---------	-------	---------------------

- | | | |
|--------------------------|---|--|
| Surface Materials | <ul style="list-style-type: none"> • Accent laminate +\$60 • Open Line laminate +\$60 plus cost of laminate | <ul style="list-style-type: none"> ▶ See <i>Surface Materials Reference Manual</i>. ▶ See <i>Surface Materials Reference Manual</i>. |
|--------------------------|---|--|

- | | | |
|-------------------------|--|--|
| Related Products | <ul style="list-style-type: none"> • Legs and tether bracket for Universal Freestanding Worksurfaces • Worksurface screens • Worksurface power and communication components • Pathways Post and Beam | <ul style="list-style-type: none"> ▶ Page D74 ▶ Page D77 ▶ Page D81 ▶ See <i>Pathways Post and Beam</i> chapter. |
|-------------------------|--|--|

Specification Information

Base Prices
Laminate



Planning Dimensions				Style Number	Vinyl P-Edge Suffix P	Base Price
A	B	C	D			
24"	24"	42"	42"	BCC224242 __		\$520
24"	24"	48"	48"	BCC224848 __		\$560
30"	30"	48"	48"	BCC334848 __		\$600
:	:	:	:	:	:	:

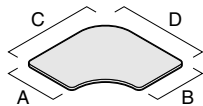

Tip: Your specification is not complete until you add a suffix to the style number to define the edge profile (for example, BZC302460__ becomes BZC302460V for wood with vinyl P-edge profile).

Worksurfaces

30" Radius Corner, Straight-Front Worksurfaces

Laminate or Wood Veneer

SIN 711.1



Standard Includes

- Worksurface: laminate or wood veneer
- Laminate worksurface: plastic P-edge profile on all sides
- Wood worksurface: wood square 3 mm, wood tapered, or 6000 Black plastic P-edge profile on all sides

Required to Specify

- 1 Style number with appropriate edge profile suffix in the space provided
 - P** Laminate with vinyl P-edge
 - V** Wood with vinyl P-edge
 - SW** Wood with square edge
 - BW** Wood with tapered edge
 - 2 Laminate or wood color number for worksurface
 - 3 Plastic color number for P-edge on laminate worksurface, if selected
 - 4 Options, if selected (see below)
- ▶ See *Surface Materials*, page D102.

Options

Surface Materials	Options	Price	Required to Specify
	Laminate worksurfaces		
	• Accent laminate	+\$60	▶ See <i>Surface Materials Reference Manual</i> .
	• Open Line laminate	+\$60 plus cost of laminate	▶ See <i>Surface Materials Reference Manual</i> .
	Wood veneer worksurfaces		
	• Customiz stain	Prices below	Specify with <i>Customiz stain</i> . ▶ See <i>Surface Materials Reference Manual</i> .
	• Full-fill finish	Prices below	Specify full-fill finish number.

Related Products	Options	Price	Required to Specify
	• Legs and tether bracket for Universal Freestanding Worksurfaces		▶ Page D74
	• Worksurface screens		▶ Page D77
	• Worksurface power and communication components		▶ Page D81
	• Pathways Post and Beam		▶ See <i>Pathways Post and Beam</i> chapter.

Tip: Legs to support free-standing worksurfaces must be specified separately.

Tip: For leg and support guidelines, refer to the Leg Matrix.
▶ See *Unison Specification Guide*.

Tip: Tether brackets to attach to Pathways Post and Beam fence must be specified separately.

Specification Information

Planning Dimensions				Style Number	Base Prices				Options (Add \$ to Base Price)	
					Laminate		Wood			
A	B	C	D		Vinyl P-Edge Suffix P	Vinyl P-Edge Suffix V	Wood Square Edge Suffix SW	Wood Tapered Edge Suffix BW	Customiz Stain on Wood	Full-Fill Finish
24"	24"	42"	42"	BBC224242 __	\$520	\$720	\$805	\$860	+\$48	+\$48
24"	24"	48"	48"	BBC224848 __	\$560	\$760	\$845	\$900	+\$50	+\$50
30"	30"	48"	48"	BBC334848 __	\$600	\$800	\$885	\$940	+\$52	+\$52

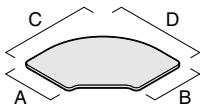

Tip: Your specification is not complete until you add a suffix to the style number to define the edge profile (for example, BZC302460__ becomes BZC302460V for wood with vinyl P-edge profile).

30" Radius Corner, Curved-Front Worksurfaces

Laminate or Wood Veneer

30" Radius Corner,
Curved-Front Worksurfaces

SIN 711.1



Standard Includes	Required to Specify
-------------------	---------------------

- Worksurface: laminate or wood veneer
- Laminate worksurface: plastic P-edge profile on all sides
- Wood worksurface: wood square 3 mm, wood tapered, or 6000 Black plastic P-edge profile on all sides

- 1 Style number with appropriate edge profile suffix in the space provided
 - P** Laminate with vinyl P-edge
 - V** Wood with vinyl P-edge
 - SW** Wood with square edge
 - BW** Wood with tapered edge
 - 2 Laminate or wood color number for worksurface
 - 3 Plastic color number for P-edge on laminate worksurface, if selected
 - 4 Options, if selected (see below)
- ▶ See *Surface Materials*, page D102.

Options	Price	Required to Specify
---------	-------	---------------------

Surface Materials	Laminate worksurfaces	Price	Required to Specify
	<ul style="list-style-type: none"> • Accent laminate • Open Line laminate 	+\$60 +\$60 plus cost of laminate	<ul style="list-style-type: none"> ▶ See <i>Surface Materials Reference Manual</i>. ▶ See <i>Surface Materials Reference Manual</i>.
	Wood veneer worksurfaces		
	<ul style="list-style-type: none"> • Customiz stain • Full-fill finish 	Prices below Prices below	Specify with <i>Customiz stain</i> . ▶ See <i>Surface Materials Reference Manual</i> . Specify full-fill finish number.

Related Products	Options	Price	Required to Specify
	<ul style="list-style-type: none"> • Legs and tether bracket for Universal Freestanding Worksurfaces • Worksurface screens • Worksurface power and communication components • Pathways Post and Beam 		<ul style="list-style-type: none"> ▶ Page D74 ▶ Page D77 ▶ Page D81 ▶ See <i>Pathways Post and Beam</i> chapter.

Tip: Legs to support free-standing worksurfaces must be specified separately.

Tip: For leg and support guidelines, refer to the Leg Matrix.
▶ See *Unison Specification Guide*.

Tip: Tether brackets to attach to Pathways Post and Beam fence must be specified separately.

Specification Information

		Base Prices								
		Laminate	Wood		Options					
Planning Dimensions A B C D		Vinyl P-Edge	Vinyl P-Edge	Wood Square Edge	Wood Tapered Edge	(Add \$ to Base Price)		Customiz Stain on Wood		
		Suffix P	Suffix V	Suffix SW	Suffix BW	Full-Fill Finish				
24"	24"	42"	42"	BRC224242	\$520	\$720	\$805	\$860	+\$48	+\$48
24"	24"	48"	48"	BRC224848	\$560	\$760	\$845	\$900	+\$50	+\$50
30"	30"	48"	48"	BRC334848	\$600	\$800	\$885	\$940	+\$53	+\$53

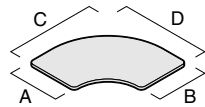

Tip: Your specification is not complete until you add a suffix to the style number to define the edge profile (for example, BZC302460 becomes BZC302460V for wood with vinyl P-edge profile).

Extended Corner, Straight-Front Worksurfaces

Laminate or Wood Veneer

SIN 711.1

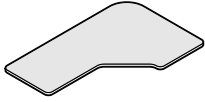

Tip: Illustration above shows a left-hand work surface.

Standard Includes	Required to Specify
<ul style="list-style-type: none"> • Worksurface: laminate or wood veneer • Laminate worksurface: plastic P-edge profile on all sides • Wood worksurface: wood square 3 mm, wood tapered, or 6000 Black plastic P-edge profile on all sides • Reinforcing brace for worksurfaces wider than 60"W 	<ol style="list-style-type: none"> 1 Style number with appropriate edge profile suffix in the space provided <ul style="list-style-type: none"> P Laminate with vinyl P-edge V Wood with vinyl P-edge SW Wood with square edge BW Wood with tapered edge ▶ See edge profiles at right 2 Laminate or wood color number for worksurface 3 Plastic color number for P-edge on laminate worksurface, if selected 4 Options, if selected (see below) ▶ See <i>Surface Materials</i>, page D102.

Options	Price	Required to Specify
Surface Materials		
Laminate worksurfaces		
<ul style="list-style-type: none"> • Accent laminate • Open Line laminate 	+\$60 +\$60 plus cost of laminate	<ul style="list-style-type: none"> ▶ See <i>Surface Materials Reference Manual</i>. ▶ See <i>Surface Materials Reference Manual</i>.
Wood veneer worksurfaces		
<ul style="list-style-type: none"> • Customiz stain • Full-fill finish 	Prices at right Prices at right	<ul style="list-style-type: none"> Specify with <i>Customiz stain</i>. ▶ See <i>Surface Materials Reference Manual</i>. Specify full-fill finish number.
Related Products		
<ul style="list-style-type: none"> • Legs and tether bracket for Universal Freestanding Worksurfaces • Worksurface screens • Worksurface power and communication components • Pathways Post and Beam 		<ul style="list-style-type: none"> ▶ Page D74 ▶ Page D77 ▶ Page D81 ▶ See <i>Pathways Post and Beam</i> chapter.

Tip: Legs to support free-standing worksurfaces must be specified separately.

Tip: For leg and support guidelines, refer to the Leg Matrix.
▶ See *Unison Specification Guide*.

Tip: Tether brackets to attach to Pathways Post and Beam fence must be specified separately.

Tip: Your specification is not complete until you add a suffix to the style number to define the edge profile (for example, BZC302460_ becomes BZC302460V for wood with vinyl P-edge profile).

Specification Information

Planning Dimensions				Style Number	Base Prices		Options		
A	B	C	D		Laminate	Wood	Vinyl P-Edge	Wood Tapered Edge	(Add \$ to Base Price)
						Vinyl P-Edge	Wood Square Edge	Wood Tapered Edge	Customiz : Full-Fill Stain on : Finish Wood :
						Suffix P	Suffix V	Suffix SW	Suffix BW

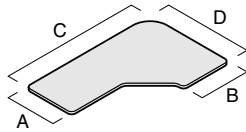

Left-Hand Worksurfaces

24"	24"	60"	42"	BE226042L_	\$750	\$1020	\$1105	\$1185	+\$54	+\$54
24"	24"	66"	42"	BE226642L_	\$775	\$1045	\$1130	\$1210	+\$68	+\$68
24"	24"	72"	42"	BE227242L_	\$800	\$1070	\$1155	\$1235	+\$69	+\$69
24"	24"	78"	42"	BE227842L_	\$825	\$1095	\$1180	\$1260	+\$71	+\$71
24"	24"	60"	48"	BE226048L_	\$775	\$1045	\$1130	\$1210	+\$68	+\$68
24"	24"	66"	48"	BE226648L_	\$800	\$1070	\$1155	\$1235	+\$69	+\$69
24"	24"	72"	48"	BE227248L_	\$825	\$1095	\$1180	\$1260	+\$71	+\$71
24"	24"	78"	48"	BE227848L_	\$850	\$1120	\$1205	\$1285	+\$72	+\$72
30"	24"	60"	48"	BE326048L_	N.A.	\$1070	\$1155	\$1235	+\$69	+\$69
30"	24"	66"	48"	BE326648L_	N.A.	\$1095	\$1180	\$1260	+\$71	+\$71
30"	24"	72"	48"	BE327248L_	N.A.	\$1120	\$1205	\$1285	+\$72	+\$72
30"	24"	78"	48"	BE327848L_	N.A.	\$1145	\$1230	\$1310	+\$74	+\$74
30"	30"	60"	48"	BE336048L_	\$825	N.A.	N.A.	N.A.	N.A.	N.A.
30"	30"	66"	48"	BE336648L_	\$850	N.A.	N.A.	N.A.	N.A.	N.A.
30"	30"	72"	48"	BE337248L_	\$875	N.A.	N.A.	N.A.	N.A.	N.A.
30"	30"	78"	48"	BE337848L_	\$900	N.A.	N.A.	N.A.	N.A.	N.A.

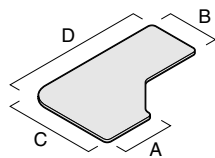

Right-Hand Worksurfaces

24"	24"	42"	60"	BE224260R_	\$750	\$1020	\$1105	\$1185	+\$54	+\$54
24"	24"	42"	66"	BE224266R_	\$775	\$1045	\$1130	\$1210	+\$68	+\$68
24"	24"	42"	72"	BE224272R_	\$800	\$1070	\$1155	\$1235	+\$69	+\$69
24"	24"	42"	78"	BE224278R_	\$825	\$1095	\$1180	\$1260	+\$71	+\$71
24"	24"	48"	60"	BE224860R_	\$775	\$1045	\$1130	\$1210	+\$68	+\$68
24"	24"	48"	66"	BE224866R_	\$800	\$1070	\$1155	\$1235	+\$69	+\$69
24"	24"	48"	72"	BE224872R_	\$825	\$1095	\$1180	\$1260	+\$71	+\$71
24"	24"	48"	78"	BE224878R_	\$850	\$1120	\$1205	\$1285	+\$72	+\$72
24"	30"	48"	60"	BE234860R_	N.A.	\$1070	\$1155	\$1235	+\$69	+\$69
24"	30"	48"	66"	BE234866R_	N.A.	\$1095	\$1180	\$1260	+\$71	+\$71
24"	30"	48"	72"	BE234872R_	N.A.	\$1120	\$1205	\$1285	+\$72	+\$72
24"	30"	48"	78"	BE234878R_	N.A.	\$1145	\$1230	\$1310	+\$74	+\$74
30"	30"	60"	48"	BE334860R_	\$825	N.A.	N.A.	N.A.	N.A.	N.A.
30"	30"	66"	48"	BE334866R_	\$850	N.A.	N.A.	N.A.	N.A.	N.A.
30"	30"	72"	48"	BE334872R_	\$875	N.A.	N.A.	N.A.	N.A.	N.A.
30"	30"	78"	48"	BE334878R_	\$900	N.A.	N.A.	N.A.	N.A.	N.A.

Worksurfaces

Corner, 120° Worksurfaces

Laminate or Wood Veneer

SIN 711.1



Tip: Legs to support free-standing worksurfaces must be specified separately.

Tip: For leg and support guidelines, refer to the Leg Matrix.

▶ See Unison Specification Guide.

Tip: Tether brackets to attach to Pathways Post and Beam fence must be specified separately.

Tip: Your specification is not complete until you add a suffix to the style number to define the edge profile (for example, BZC302460 becomes BZC302460V for wood with vinyl P-edge profile).

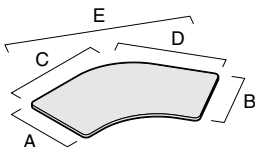

Tip: Screens can be used on corner, 120° worksurfaces.

- 24"W screens can be used on worksurfaces with dimensions C and D each equal to 43".

- 24"W and 30"W screens can be used on worksurfaces with dimensions C and D each equal to 49".

Tip: Corner, 120° worksurfaces with dimensions C and D each equal to 37" cannot accommodate screens.

Standard Includes	Required to Specify
-------------------	---------------------

- Worksurface: laminate or wood veneer
- Laminate worksurface: plastic P-edge profile on all sides
- Wood worksurface: wood square 3 mm, wood tapered, or 6000 Black plastic P-edge profile on all sides

- 1 Style number with appropriate edge profile suffix in the space provided
 - P** Laminate with vinyl P-edge
 - V** Wood with vinyl P-edge
 - SW** Wood with square edge
 - BW** Wood with tapered edge
- ▶ See edge profiles below
- 2 Laminate or wood color number for worksurface
- 3 Plastic color number for P-edge on laminate worksurface, if selected
- 4 Options, if selected (see below)
- ▶ See *Surface Materials*, page D102.

Options	Price	Required to Specify
---------	-------	---------------------

Surface Materials	Laminate worksurfaces	Price	Required to Specify
	• Accent laminate	+\$60	▶ See <i>Surface Materials Reference Manual</i> . ▶ See <i>Surface Materials Reference Manual</i> .
	• Open Line laminate	+\$60 plus cost of laminate	

Surface Materials	Wood veneer worksurfaces	Price	Required to Specify
	• Customiz stain	Prices below	Specify with <i>Customiz stain</i> . ▶ See <i>Surface Materials Reference Manual</i> .
	• Full-fill finish	Prices below	Specify full-fill finish number.

Related Products	Options	Price	Required to Specify
	• Legs and tether bracket for Universal Freestanding Worksurfaces		▶ Page D74
	• Worksurface screens		▶ Page D77
	• Worksurface power and communication components		▶ Page D81
	• Pathways Post and Beam		▶ See <i>Pathways Post and Beam</i> chapter.

Specification Information

• Planning Dimensions A B C D E					• Style Number				• Options		
					• Vinyl P-Edge		• Vinyl P-Edge		• Wood Square Edge		• Wood Tapered Edge
					• Suffix P	• Suffix V	• Suffix SW	• Suffix BW			
24"	24"	36"	36"	62"	BFB223636	\$800	\$1070	\$1155	\$1235	+\$69	+\$69
24"	24"	42"	42"	73"	BFB224242	\$825	\$1095	\$1180	\$1260	+\$71	+\$71
24"	24"	48"	48"	83"	BFB224848	\$850	\$1120	\$1205	\$1285	+\$72	+\$72
30"	30"	42"	42"	73"	BFB334242	\$850	\$1120	\$1205	\$1285	+\$72	+\$72
30"	30"	48"	48"	83"	BFB334848	\$875	\$1145	\$1230	\$1310	+\$74	+\$74

Capsule Worksurfaces

Laminate or Wood Veneer

SIN 711.1

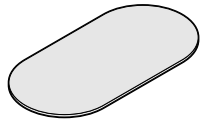

Standard Includes	Required to Specify
-------------------	---------------------

- Worksurface: laminate or wood veneer
- Laminate worksurface: plastic P-edge profile on all sides
- Wood worksurface: wood square 3 mm, wood tapered, or 6000 Black plastic P-edge profile on all sides
- Reinforcing brace for worksurfaces wider than 60"W

- 1 Style number with appropriate edge profile suffix in the space provided
 - P** Laminate with vinyl P-edge
 - V** Wood with vinyl P-edge
 - SW** Wood with square edge
 - BW** Wood with tapered edge
 - 2 Laminate or wood color number for worksurface
 - 3 Plastic color number for P-edge on laminate worksurface, if selected
 - 4 Options, if selected (see below)
- ▶ See *Surface Materials*, page D102.

Options	Price	Required to Specify
---------	-------	---------------------

Surface Materials	Laminate worksurfaces		
	<ul style="list-style-type: none"> • Accent laminate +\$60 • Open Line laminate +\$60 plus cost of laminate 		<ul style="list-style-type: none"> ▶ See <i>Surface Materials Reference Manual</i>. ▶ See <i>Surface Materials Reference Manual</i>.
	Wood veneer worksurfaces		
	<ul style="list-style-type: none"> • Customiz stain Prices below • Full-fill finish Prices below 		<ul style="list-style-type: none"> Specify with <i>Customiz stain</i>. ▶ See <i>Surface Materials Reference Manual</i>. Specify full-fill finish number.

Related Products	Options	Price	Required to Specify
------------------	---------	-------	---------------------

Related Products	<ul style="list-style-type: none"> • Legs and tether bracket for Universal Freestanding Worksurfaces • Worksurface screens • Worksurface power and communication components • Pathways Post and Beam 		<ul style="list-style-type: none"> ▶ Page D74 ▶ Page D77 ▶ Page D81 ▶ See <i>Pathways Post and Beam</i> chapter.
-------------------------	--	--	--

Tip: Legs to support free-standing worksurfaces must be specified separately.

Tip: For leg and support guidelines, refer to the Leg Matrix.
▶ See *Unison Specification Guide*.

Tip: Tether brackets to attach to Pathways Post and Beam fence must be specified separately.

Specification Information

Planning Dimensions A B		Style Number	Base Prices				Options (Add \$ to Base Price) Customiz Stain on Wood Full-Fill Finish	
			Vinyl P-Edge Suffix P	Vinyl P-Edge Suffix V	Wood Square Edge Suffix SW	Wood Tapered Edge Suffix BW		
24"	48"	BFK2448 __	\$ 499	N.A.	N.A.	N.A.	N.A.	N.A.
30"	60"	BFK3060 __	\$ 640	N.A.	N.A.	N.A.	N.A.	N.A.
36"	72"	BFK3672 __	\$ 950	\$1248	\$1333	\$1413	+\$80	+\$80
42"	84"	BFK4284 __	\$1018	\$1318	\$1403	\$1483	+\$84	+\$84
48"	96"	BFK4896 __	\$1058	\$1358	\$1443	\$1523	+\$86	+\$86

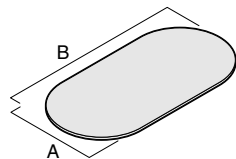

Tip: Your specification is not complete until you add a suffix to the style number to define the edge profile (for example, BZC302460__ becomes BZC302460V for wood with vinyl P-edge profile).

Spanner Worksurfaces

Laminate or Wood Veneer

SIN 711.1



Standard Includes	Required to Specify
-------------------	---------------------

- Worksurface: laminate or wood veneer
- Laminate worksurface: plastic P-edge profile on all sides
- Wood worksurface: wood square 3 mm, wood tapered, or 6000 Black plastic P-edge profile on all sides

- 1 Style number with appropriate edge profile suffix in the space provided
 - P** Laminate with vinyl P-edge
 - V** Wood with vinyl P-edge
 - SW** Wood with square edge
 - BW** Wood with tapered edge
- ▶ See edge profiles below
- 2 Laminate or wood color number for worksurface
- 3 Plastic color number for P-edge on laminate worksurface, if selected
- 4 Options, if selected (see below)
- ▶ See *Surface Materials*, page D102.

Options	Price	Required to Specify
---------	-------	---------------------

Surface Materials	Laminate worksurfaces		
	<ul style="list-style-type: none"> • Accent laminate +\$60 • Open Line laminate +\$60 plus cost of laminate 		<ul style="list-style-type: none"> ▶ See <i>Surface Materials Reference Manual</i>. ▶ See <i>Surface Materials Reference Manual</i>.
	Wood veneer worksurfaces		
	<ul style="list-style-type: none"> • Customiz stain Prices below • Full-fill finish Prices below 		<ul style="list-style-type: none"> Specify with <i>Customiz stain</i>. ▶ See <i>Surface Materials Reference Manual</i>. Specify full-fill finish number.

Related Products	<ul style="list-style-type: none"> • Legs and tether bracket for Universal Freestanding Worksurfaces • Worksurface screens • Worksurface power and communication components • Pathways Post and Beam 	<ul style="list-style-type: none"> ▶ Page D74 ▶ Page D77 ▶ Page D81 ▶ See <i>Pathways Post and Beam</i> chapter.
-------------------------	--	--

Tip: Legs to support free-standing worksurfaces must be specified separately.

Tip: For leg and support guidelines, refer to the Leg Matrix.
▶ See *Unison Specification Guide*.

Tip: Tether brackets to attach to Pathways Post and Beam fence must be specified separately.

Specification Information

• Planning Dimensions A B		• Style Number	Base Prices				• Options (Add \$ to Base Price) Customiz : Full-Fill Stain on : Finish Wood :	
			• Vinyl P-Edge Suffix P	• Vinyl P-Edge Suffix V	• Wood Square Edge Suffix SW	• Wood Tapered Edge Suffix BW		
30"	48"	BFSP48 __	\$537	\$807	\$892	\$ 972	+\$53	+\$53
30"	52"	BFSP52 __	\$557	\$827	\$912	\$ 992	+\$55	+\$55
36"	60"	BFSP60 __	\$616	\$847	\$932	\$1012	+\$56	+\$56
36"	64"	BFSP64 __	\$635	\$867	\$952	\$1032	+\$57	+\$57

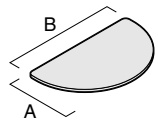

Tip: Your specification is not complete until you add a suffix to the style number to define the edge profile (for example, BZC302460__ becomes BZC302460V for wood with vinyl P-edge profile).

Peninsula Worksurfaces

Laminate or Wood Veneer

SIN 711.1



Standard Includes	Required to Specify
-------------------	---------------------

- | | |
|--|--|
| <ul style="list-style-type: none"> • Worksurface: laminate or wood veneer • Laminate worksurface: plastic P-edge profile on all sides • Wood worksurface: wood square 3 mm, wood tapered, or 6000 Black plastic P-edge profile on all sides | <ol style="list-style-type: none"> 1 Style number with appropriate edge profile suffix in the space provided <ul style="list-style-type: none"> P Laminate with vinyl P-edge V Wood with vinyl P-edge SW Wood with square edge BW Wood with tapered edge ▶ See edge profiles below 2 Laminate or wood color number for worksurface 3 Plastic color number for P-edge on laminate worksurface, if selected 4 Options, if selected (see below) ▶ See <i>Surface Materials</i>, page D102. |
|--|--|

Options	U.S. Price	Required to Specify
---------	------------	---------------------

Surface Materials	Laminate worksurfaces		
	<ul style="list-style-type: none"> • Accent laminate +\$60 • Open Line laminate +\$60 plus cost of laminate 		<ul style="list-style-type: none"> ▶ See <i>Surface Materials Reference Manual</i>. ▶ See <i>Surface Materials Reference Manual</i>.
	Wood veneer worksurfaces		
	<ul style="list-style-type: none"> • Customiz stain Prices below • Full-fill finish Prices below 		<ul style="list-style-type: none"> Specify with <i>Customiz stain</i>. ▶ See <i>Surface Materials Reference Manual</i>. Specify full-fill finish number.
Related Products	<ul style="list-style-type: none"> • Legs and tether bracket for Universal Freestanding Worksurfaces • Worksurface screens • Pathways Post and Beam 		<ul style="list-style-type: none"> ▶ Page D74 ▶ Page D77 ▶ See <i>Pathways Post and Beam</i> chapter.

Tip: Legs to support free-standing worksurfaces must be specified separately.

Tip: For leg and support guidelines, refer to the Leg Matrix.
▶ See *Unison Specification Guide*.

Tip: Tether brackets to attach to Pathways Post and Beam fence must be specified separately.

Specification Information

Planning Dimensions A B	Style Number	U.S. Base Prices				Options (Add \$ to Base Price)	
		Laminate	Wood				
		Vinyl P-Edge Suffix P	Vinyl P-Edge Suffix V	Wood Square Edge Suffix SW	Wood Tapered Edge Suffix BW	Customiz Stain on Wood	Full-Fill Finish
27" 36"	BFP2736	\$497	\$767	\$852	\$932	+\$51	+\$51

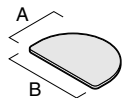

Tip: Your specification is not complete until you add a suffix to the style number to define the edge profile (for example, BZC302460 becomes BZC302460V for wood with vinyl P-edge profile).

Worksurfaces

Tapered Peninsula Worksurfaces

Laminate or Wood Veneer

SIN 711.1

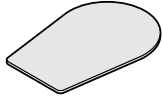

Standard Includes	Required to Specify
-------------------	---------------------

- Worksurface: laminate or wood veneer
- Laminate worksurface: plastic P-edge profile on all sides
- Wood worksurface: wood square 3 mm, wood tapered, or 6000 Black plastic P-edge profile on all sides

- 1 Style number with appropriate edge profile suffix in the space provided
 - P** Laminate with vinyl P-edge
 - V** Wood with vinyl P-edge
 - SW** Wood with square edge
 - BW** Wood with tapered edge
- ▶ See edge profiles below
- 2 Laminate or wood color number for worksurface
- 3 Plastic color number for P-edge on laminate worksurface, if selected
- 4 Options, if selected (see below)
- ▶ See *Surface Materials*, page D102.

Options	Price	Required to Specify
---------	-------	---------------------

Surface Materials	Laminate worksurfaces	Price	Required to Specify
	<ul style="list-style-type: none"> • Accent laminate • Open Line laminate 	+\$60 +\$60 plus cost of laminate	<ul style="list-style-type: none"> ▶ See <i>Surface Materials Reference Manual</i>. ▶ See <i>Surface Materials Reference Manual</i>.
	Wood veneer worksurfaces		
	<ul style="list-style-type: none"> • Customiz stain • Full-fill finish 	Prices below Prices below	Specify with <i>Customiz stain</i> . ▶ See <i>Surface Materials Reference Manual</i> . Specify full-fill finish number.

Related Products	Options	Price	Required to Specify
	<ul style="list-style-type: none"> • Legs and tether bracket for Universal Freestanding Worksurfaces • Worksurface screens • Worksurface power and communication components • Pathways Post and Beam 		<ul style="list-style-type: none"> ▶ Page D74 ▶ Page D77 ▶ Page D81 ▶ See <i>Pathways Post and Beam</i> chapter.

Tip: Legs to support free-standing worksurfaces must be specified separately.

Tip: For leg and support guidelines, refer to the Leg Matrix.
▶ See *Unison Specification Guide*.

Tip: Tether brackets to attach to Pathways Post and Beam fence must be specified separately.

Specification Information

Planning Dimensions A B C			Style Number	Base Prices				Options (Add \$ to Base Price) Customiz Stain on Wood : Full-Fill Finish	
				Laminate	Wood	Wood	Wood		
				Vinyl P-Edge Suffix P	Vinyl P-Edge Suffix V	Wood Square Edge Suffix SW	Wood Tapered Edge Suffix BW		
27"	32"	48"	BFTP48 __	\$595	\$705	\$790	\$870	+\$47	+\$47
33"	40"	60"	BFTP60 __	\$645	\$755	\$840	\$920	+\$50	+\$50

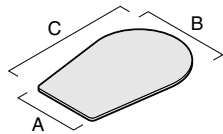

Tip: Your specification is not complete until you add a suffix to the style number to define the edge profile (for example, BZC302460__ becomes BZC302460V for wood with vinyl P-edge profile).

Bubble Jetty Worksurfaces

Laminate or Wood Veneer

SIN 711.1

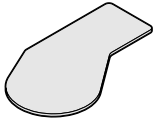

Tip: Illustration above shows a left-hand unit.

Tip: Legs to support free-standing worksurfaces must be specified separately.

Tip: For leg and support guidelines, refer to the Leg Matrix.

▶ See Unison Specification Guide.

Tip: Tether brackets to attach to Pathways Post and Beam fence must be specified separately.

Tip: Your specification is not complete until you add a suffix to the style number to define the edge profile (for example, BZC302460_ becomes BZC302460V for wood with vinyl P-edge profile).

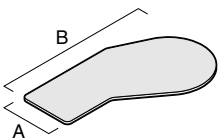
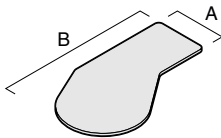

Standard Includes	Required to Specify
-------------------	---------------------

- Worksurface: laminate or wood veneer
- Laminate worksurface: plastic P-edge profile on all sides
- Wood worksurface: wood square 3 mm, wood tapered, or 6000 Black plastic P-edge profile on all sides

- 1 Style number with appropriate edge profile suffix in the space provided
 - P** Laminate with vinyl P-edge
 - V** Wood with vinyl P-edge
 - SW** Wood with square edge
 - BW** Wood with tapered edge
- ▶ See edge profiles below
- 2 Laminate or wood color number for worksurface
- 3 Plastic color number for P-edge on laminate worksurface, if selected
- 4 Options, if selected (see below)
- ▶ See *Surface Materials*, page D102.

Surface Materials	Options	U.S. Price	Required to Specify
-------------------	---------	------------	---------------------

Surface Materials	Laminate worksurfaces		
	<ul style="list-style-type: none"> • Accent laminate +\$60 • Open Line laminate +\$60 plus cost of laminate 		<ul style="list-style-type: none"> ▶ See <i>Surface Materials Reference Manual</i>. ▶ See <i>Surface Materials Reference Manual</i>.

	Wood veneer worksurfaces		
	<ul style="list-style-type: none"> • Customiz stain Prices below • Full-fill finish Prices below 		Specify with <i>Customiz stain</i> . ▶ See <i>Surface Materials Reference Manual</i> . Specify full-fill finish number.

Related Products	<ul style="list-style-type: none"> • Legs and tether bracket for Universal Freestanding Worksurfaces • Worksurface screens • Worksurface power and communication components • Pathways Post and Beam 		<ul style="list-style-type: none"> ▶ Page D74 ▶ Page D77 ▶ Page D81 ▶ See <i>Pathways Post and Beam</i> chapter.
-------------------------	--	--	--

Specification Information

Planning Dimensions A B	Style Number	U.S. Base Prices				Options (Add \$ to Base Price) Customiz Stain on Wood	Full-Fill Finish
		Vinyl P-Edge Suffix P	Vinyl P-Edge Suffix V	Wood Square Edge Suffix SW	Wood Tapered Edge Suffix BW		

Left-Hand Worksurfaces

24"	72"	BFJ2472L_	\$820	\$1090	\$1175	\$1255	+\$70	+\$70
24"	78"	BFJ2478L_	\$870	\$1150	\$1235	\$1315	+\$74	+\$74
30"	72"	BFJ3072L_	\$860	\$1150	\$1235	\$1315	+\$74	+\$74
30"	78"	BFJ3078L_	\$910	\$1240	\$1325	\$1405	+\$79	+\$79
:	:	:	:	:	:	:	:	:

Right-Hand Worksurfaces

24"	72"	BFJ2472R_	\$820	\$1090	\$1175	\$1255	+\$70	+\$70
24"	78"	BFJ2478R_	\$870	\$1150	\$1235	\$1315	+\$74	+\$74
30"	72"	BFJ3072R_	\$860	\$1150	\$1235	\$1315	+\$74	+\$74
30"	78"	BFJ3078R_	\$910	\$1240	\$1325	\$1405	+\$79	+\$79
:	:	:	:	:	:	:	:	:

Round Worksurfaces

Laminate or Wood Veneer

SIN 711.1



Standard Includes	Required to Specify
-------------------	---------------------

- Worksurface: laminate or wood veneer
- Laminate worksurface: plastic P-edge profile on all sides
- Wood worksurface: wood square 3 mm, wood tapered, or 6000 Black plastic P-edge profile on all sides

- 1 Style number with appropriate edge profile suffix in the space provided
 - P** Laminate with vinyl P-edge
 - V** Wood with vinyl P-edge
 - SW** Wood with square edge
 - BW** Wood with tapered edge
- ▶ See edge profiles below
- 2 Laminate or wood color number for worksurface
- 3 Plastic color number for P-edge on laminate worksurface, if selected
- 4 Options, if selected (see below)
- ▶ See *Surface Materials*, page D102.

Options	Price	Required to Specify
---------	-------	---------------------

Surface Materials	Laminate worksurfaces	Price	Required to Specify
	<ul style="list-style-type: none"> • Accent laminate • Open Line laminate 	+\$60 +\$60 plus cost of laminate	<ul style="list-style-type: none"> ▶ See <i>Surface Materials Reference Manual</i>. ▶ See <i>Surface Materials Reference Manual</i>.
	Wood veneer worksurfaces		
	<ul style="list-style-type: none"> • Customiz stain • Full-fill finish 	Prices below Prices below	Specify with <i>Customiz stain</i> . ▶ See <i>Surface Materials Reference Manual</i> . Specify full-fill finish number.

Related Products	Options	Price	Required to Specify
	• Legs and tether bracket for Universal Freestanding Worksurfaces		▶ Page D74

Tip: Legs to support free-standing worksurfaces must be specified separately.

Tip: For leg and support guidelines, refer to the Leg Matrix.
▶ See *Unison Specification Guide*.

Specification Information

• Diameter	• Style Number	Base Prices				• Options (Add \$ to Base Price) • Customiz Stain on Wood • Full-Fill Finish	
		• Vinyl P-Edge • Suffix P	• Vinyl P-Edge • Suffix V	• Wood Square Edge • Suffix SW	• Wood Tapered Edge • Suffix BW		
36"	BFR36 __	\$475	\$550	\$635	\$715	+\$38	+\$38
42"	BFR42 __	\$525	\$600	\$685	\$765	+\$41	+\$41
48"	BFR48 __	\$575	\$680	\$765	\$845	+\$46	+\$46
54"	BFR54 __	\$690	\$730	\$815	\$895	+\$49	+\$49

Tip: Your specification is not complete until you add a suffix to the style number to define the edge profile (for example, BZC302460__ becomes BZC302460V for wood with vinyl P-edge profile).

Square Worksurfaces

Laminate or Wood Veneer

SIN 711.1



Standard Includes	Required to Specify
-------------------	---------------------

- Worksurface: laminate or wood veneer
- Laminate worksurface: plastic P-edge profile on all sides
- Wood worksurface: wood square 3 mm, wood tapered, or 6000 Black plastic P-edge profile on all sides

- 1 Style number with appropriate edge profile suffix in the space provided
 - P** Laminate with vinyl P-edge
 - V** Wood with vinyl P-edge
 - SW** Wood with square edge
 - BW** Wood with tapered edge
 - 2 Laminate or wood color number for worksurface
 - 3 Plastic color number for P-edge on laminate worksurface, if selected
 - 4 Options, if selected (see below)
- ▶ See *Surface Materials*, page D102.

Options	Price	Required to Specify
---------	-------	---------------------

Surface Materials	Laminate worksurfaces	Price	Required to Specify
	<ul style="list-style-type: none"> • Accent laminate • Open Line laminate 	+\$60 +\$60 plus cost of laminate	<ul style="list-style-type: none"> ▶ See <i>Surface Materials Reference Manual</i>. ▶ See <i>Surface Materials Reference Manual</i>.
	Wood veneer worksurfaces		
	<ul style="list-style-type: none"> • Customiz stain • Full-fill finish 	Prices below Prices below	Specify with <i>Customiz stain</i> . ▶ See <i>Surface Materials Reference Manual</i> . Specify full-fill finish number.

Related Products	Options	Price	Required to Specify
	<ul style="list-style-type: none"> • Legs and tether bracket for Universal Freestanding Worksurfaces • Worksurface screens • Worksurface power and communication components • Pathways Post and Beam 		<ul style="list-style-type: none"> ▶ Page D74 ▶ Page D77 ▶ Page D81 ▶ See <i>Pathways Post and Beam</i> chapter.

Tip: Legs to support free-standing worksurfaces must be specified separately.

Tip: For leg and support guidelines, refer to the Leg Matrix.
▶ See *Unison Specification Guide*.

Tip: Tether brackets to attach 24"W and 30"W worksurfaces to Pathways Post and Beam fence must be specified separately.

Specification Information

Planning Dimensions A B		Style Number	Base Prices				Options (Add \$ to Base Price) Customiz Stain on Wood : Full-Fill Finish	
			Vinyl P-Edge Suffix P	Vinyl P-Edge Suffix V	Wood Square Edge Suffix SW	Wood Tapered Edge Suffix BW		
24"	24"	BFRQ24 __	\$240	N.A.	N.A.	N.A.	N.A.	N.A.
30"	30"	BFRQ30 __	\$340	\$470	\$555	\$635	+\$33	+\$33
36"	36"	BFRQ36 __	\$475	N.A.	N.A.	N.A.	N.A.	N.A.
42"	42"	BFRQ42 __	\$525	\$600	\$685	\$765	+\$41	+\$41
48"	48"	BFRQ48 __	\$575	\$680	\$765	\$845	+\$46	+\$46
54"	54"	BFRQ54 __	\$690	\$730	\$815	\$895	+\$49	+\$49

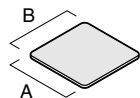

Tip: Your specification is not complete until you add a suffix to the style number to define the edge profile (for example, BZC302460__ becomes BZC302460V for wood with vinyl P-edge profile).

Worksurfaces

Rectangle Worksurfaces

Laminate or Wood Veneer

SIN 711.1

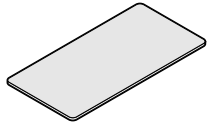

Standard Includes	Required to Specify
-------------------	---------------------

- Worksurface: laminate or wood veneer
- Laminate worksurface: plastic P-edge profile on all sides
- Wood worksurface: wood square 3 mm, wood tapered, or 6000 Black plastic P-edge profile on all sides
- Reinforcing brace for worksurfaces wider than 60"W

- 1 Style number with appropriate edge profile suffix in the space provided
 - P** Laminate with vinyl P-edge
 - V** Wood with vinyl P-edge
 - SW** Wood with square edge
 - BW** Wood with tapered edge
- ▶ See edge profiles below
- 2 Laminate or wood color number for worksurface
- 3 Plastic color number for P-edge on laminate worksurface, if selected
- 4 Options, if selected (see below)
- ▶ See *Surface Materials*, page D102.

Tip: Legs to support free-standing worksurfaces must be specified separately.

Tip: For leg and support guidelines, refer to the Leg Matrix.
▶ See *Unison Specification Guide*.

Tip: Tether brackets to attach 36"D x 72"W rectangle worksurfaces to Pathways Post and Beam fence must be specified separately.

Options	Price	Required to Specify
---------	-------	---------------------

Surface Materials	Laminate worksurfaces		
	<ul style="list-style-type: none"> • Accent laminate +\$60 • Open Line laminate +\$60 plus cost of laminate 		<ul style="list-style-type: none"> ▶ See <i>Surface Materials Reference Manual</i>. ▶ See <i>Surface Materials Reference Manual</i>.
	Wood veneer worksurfaces		
	<ul style="list-style-type: none"> • Customiz stain Prices below • Full-fill finish Prices below 		<ul style="list-style-type: none"> Specify with <i>Customiz stain</i>. ▶ See <i>Surface Materials Reference Manual</i>. Specify full-fill finish number.

Related Products	<ul style="list-style-type: none"> • Legs and tether bracket for Universal Freestanding Worksurfaces • Worksurface screens • Worksurface power and communication components • Pathways Post and Beam 	<ul style="list-style-type: none"> ▶ Page D74 ▶ Page D77 ▶ Page D81 ▶ See <i>Pathways Post and Beam</i> chapter.
-------------------------	--	--

Specification Information

• Planning Dimensions A B		• Style Number	Base Prices				• Options (Add \$ to Base Price) Customiz Full-Fill Stain on Finish Wood	
			• Vinyl P-Edge Suffix P	• Vinyl P-Edge Suffix V	• Wood Square Edge Suffix SW	• Wood Tapered Edge Suffix BW		
36"	72"	BFRR3672 __	\$ 950	\$1248	\$1333	\$1413	+\$82	+\$82
42"	84"	BFRR4284 __	\$1018	\$1318	\$1403	\$1483	+\$84	+\$84
48"	96"	BFRR4896 __	\$1058	\$1358	\$1443	\$1523	+\$86	+\$86
..

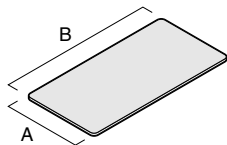

Tip: Your specification is not complete until you add a suffix to the style number to define the edge profile (for example, BZC302460__ becomes BZC302460V for wood with vinyl P-edge profile).

Hub Spanner Worksurfaces

Laminate

SIN 711.1



Tip: Hub spanner worksurfaces are available in laminate only.

Standard Includes	Required to Specify
-------------------	---------------------

- Worksurface: laminate
- Vinyl P-edge profile on all sides: plastic

- 1 Style number with appropriate edge profile suffix in the space provided
 - ▶ **P** Laminate with vinyl P-edge
 - ▶ See edge profiles below
- 2 Laminate color number for worksurface
- 3 Plastic color number for edge
- 4 Options, if selected (see below)
- ▶ See *Surface Materials*, page D102.

Options	Price	Required to Specify
---------	-------	---------------------

- | | | |
|--------------------------|---|--|
| Surface Materials | <ul style="list-style-type: none"> • Accent laminate +\$60 • Open line laminate +\$60 plus cost of laminate | <ul style="list-style-type: none"> ▶ See <i>Surface Materials Reference Manual</i>. ▶ See <i>Surface Materials Reference Manual</i>. |
|--------------------------|---|--|

Related Products	Options	Price	Required to Specify
------------------	---------	-------	---------------------

- | | | | |
|-------------------------|---|--|--|
| Related Products | <ul style="list-style-type: none"> • Legs and tether bracket for Universal Freestanding Worksurfaces • Pathways Post and Beam • Hubs | | <ul style="list-style-type: none"> ▶ Page D74 ▶ See <i>Pathways Post and Beam</i> chapter. ▶ See <i>Pathways Post and Beam Solutions Specification Guide</i>. |
|-------------------------|---|--|--|

Tip: Legs to support free-standing worksurfaces must be specified separately.

Tip: Hub spanner worksurface is a single surface.

Tip: Order two hub spanners for mobile teaming environments when a permanent connection is not desired.

Tip: Order split-round worksurface when a fixed position around a Pathways Post and Beam column and hub is desired.

Tip: Your specification is not complete until you add a suffix to the style number to define the edge profile (for example, BZC302460__ becomes BZC302460V for wood with vinyl P-edge profile).

Specification Information

Base Prices		
Laminate		
Diameter	Style Number	Vinyl P-Edge Suffix P
52"	BFSPF52__	\$616
64"	BFSPF64__	\$635



Worksurfaces

Split-Round Worksurfaces

Laminate or Wood Veneer

SIN 711.1

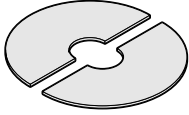

Tip: Legs to support free-standing worksurfaces must be specified separately.

Tip: When ordering legs for split-round worksurfaces to be used with Pathways Post and Beam, specify with glides.

Tip: Order split-round work-surface when a fixed position around a Pathways Post and Beam column and hub is desired.

Tip: Order two hub spanners for mobile teaming environments when a permanent connection is not desired.
▶ Page D67

Tip: For leg and support guidelines, refer to the Leg Matrix.
▶ See Unison Specification Guide.

Tip: Split-round worksurfaces are specified as a pair. Bracket kit is included to connect the two worksurfaces.

Tip: Your specification is not complete until you add a suffix to the style number to define the edge profile (for example, BZC302460__ becomes BZC302460V for wood with vinyl P-edge profile).

Standard Includes

- Pair of worksurfaces: laminate or wood veneer
- Laminate worksurfaces: plastic P-edge profile on all sides
- Wood worksurfaces: wood square 3 mm, wood tapered, or 6000 Black plastic P-edge profile on all sides
- Vinyl flat profile on inside edges: plastic default
- Bracket kit to connect worksurfaces

Required to Specify

- 1 Style number with appropriate edge profile suffix in the space provided
 - P** Laminate with vinyl P-edge
 - V** Wood with vinyl P-edge
 - SW** Wood with square edge
 - BW** Wood with tapered edge
- ▶ See edge profiles below
- 2 Laminate or wood color number for worksurface
- 3 Plastic color number for P-edge on laminate worksurface, if selected
- 4 Options, if selected (see below)
- ▶ See *Surface Materials*, page D102.

Options

Surface Materials	Options	Price	Required to Specify
	Laminate worksurfaces		
	<ul style="list-style-type: none"> • Accent laminate +\$60 • Open Line laminate +\$60 plus cost of laminate 		<ul style="list-style-type: none"> ▶ See <i>Surface Materials Reference Manual</i>. ▶ See <i>Surface Materials Reference Manual</i>.
	Wood veneer worksurfaces		
	<ul style="list-style-type: none"> • Customiz stain Prices below • Full-fill finish Prices below 		<ul style="list-style-type: none"> Specify with <i>Customiz stain</i>. ▶ See <i>Surface Materials Reference Manual</i>. Specify full-fill finish number.
Related Products	<ul style="list-style-type: none"> • Legs and tether bracket for Universal Freestanding Worksurfaces • Pathways Post and Beam • Hubs 		<ul style="list-style-type: none"> ▶ Page D74 ▶ See <i>Pathways Post and Beam</i> chapter. ▶ See <i>Pathways Post and Beam Solutions Specification Guide</i>.

Specification Information

Diameter	Style Number	Base Prices				Options	
		Vinyl P-Edge	Vinyl P-Edge	Wood Square Edge	Wood Tapered Edge	(Add \$ to Base Price)	Full-Fill Finish
		Suffix P	Suffix V	Suffix SW	Suffix BW	Customiz Stain on Wood	Full-Fill Finish
52"	BFSPN52__	\$1189	\$1559	\$1639	\$1719	+\$110	+\$110
64"	BFSPN64__	\$1345	\$1639	\$1795	\$1875	+\$114	+\$114

Tethered Capsule Worksurfaces

Laminate or Wood Veneer

SIN 711.1

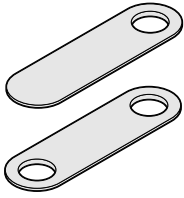

Tip: Tethered capsule work-surfaces attach to Pathways Post and Beam fence with bracket kit included. Legs do not need to be specified.

Tip: Width of tethered capsule work-surfaces includes 1" overhang on both sides of the Pathways Post and Beam fence.

Tip: Your specification is not complete until you add a suffix to the style number to define the edge profile (for example, BZC302460__ becomes BZC302460V for wood with vinyl P-edge profile).

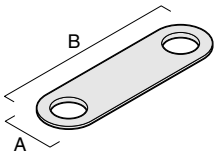
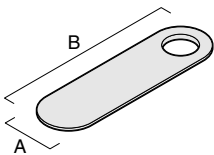

Standard Includes Required to Specify

- Worksurface: laminate or wood veneer
- Laminate worksurfaces: plastic P-edge profile on all sides
- Wood worksurfaces: wood square 3 mm, wood tapered, or 6000 Black plastic P-edge profile on all sides
- Vinyl flat profile on inside edges: plastic default
- Bracket kit to attach to Pathways Post and Beam fence

- 1 Style number with appropriate edge profile suffix in the space provided
 - P** Laminate with vinyl P-edge
 - V** Wood with vinyl P-edge
 - SW** Wood with square edge
 - BW** Wood with tapered edge
- ▶ See edge profiles below
- 2 Laminate or wood color number for worksurface
- 3 Plastic color number for P-edge on laminate worksurface, if selected
- 4 Options, if selected (see below)
- ▶ See *Surface Materials*, page D102.

Options Price Required to Specify

Surface Materials	Options	Price	Required to Specify
	Laminate worksurfaces		
	• Accent laminate	+\$60	▶ See <i>Surface Materials Reference Manual</i> .
	• Open Line laminate	+\$60 plus cost of laminate	▶ See <i>Surface Materials Reference Manual</i> .
	Wood veneer worksurfaces		
	• Customiz stain	Prices below	Specify with <i>Customiz stain</i> . ▶ See <i>Surface Materials Reference Manual</i> .
	• Full-fill finish	Prices below	Specify full-fill finish number.
Related Products	• Pathways Post and Beam		▶ See <i>Pathways Post and Beam</i> chapter.
	• Hubs		▶ See <i>Pathways Post and Beam Solutions Specification Guide</i> .

Specification Information

• Planning Dimensions A B	• Style Number	Base Prices				• Options (Add \$ to Base Price)
		• Vinyl P-Edge Suffix P	• Vinyl P-Edge Suffix V	• Wood Square Edge Suffix SW	• Wood Tapered Edge Suffix BW	
		• Customiz Stain on Wood				• Full-Fill Finish

Worksurface with One Cutout

26"	66"	BFFF661__	\$ 750	\$1068	\$1153	\$1233	+\$69	+\$69
26"	74"	BFFF721__	\$ 800	\$1148	\$1233	\$1313	+\$74	+\$74
26"	86"	BFFF841__	\$ 850	\$1218	\$1303	\$1383	+\$78	+\$78
26"	98"	BFFF961__	\$ 900	\$1258	\$1343	\$1423	+\$80	+\$80

Worksurface with Two Cutouts

26"	98"	BFFF962__	\$1050	\$1423	\$1393	\$1482	+\$80	+\$80

Adjustable-Height Worksurfaces

Laminate, with Crank

SIN 711.1

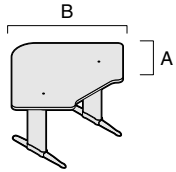

Tip: Adjustable-height work-surfaces are available in laminate only.

Tip: Adjustable-height mechanism requires assembly and attachment to the worksurface.

Tip: 45¼" dual corner and bi-level corner worksurfaces can support both a keyboard and a mouse pad on the same surface.

Standard Includes	Required to Specify
-------------------	---------------------

- Worksurface: laminate
- Vinyl P-edge profile on all sides: plastic
- Adjustable-height mechanism
- Leg shrouds and feet: paint price group 1
- Crank handle

- 1 Style number
 - 2 Laminate color number for worksurface
 - 3 Plastic color number for edge
 - 4 Paint color number for leg shrouds and feet
 - 5 Options, if selected (see below)
- ▶ See *Surface Materials*, page D102.

Options	Price	Required to Specify
---------	-------	---------------------

Surface Materials

- Paint price group 1
- Paint price group 2
- Paint price group 3
- Accent laminate
- Open Line laminate

No cost
 +\$34
 +\$58
 +\$60
 +\$60
 plus cost of laminate

Specify paint color number.
 Specify paint color number.
 Specify paint color number.
 ▶ See *Surface Materials Reference Manual*.
 ▶ See *Surface Materials Reference Manual*.

Specification Information			
Planning Dimensions	Style Number	Base Price	
A	B	Price	

Planning Dimensions	Style Number	Base Price	
A	B	Price	

Corner, Straight-Front Worksurfaces

24"	42"	BCKSC42P	\$1686
24"	48"	BCKSC48P	\$1726
:	:	:	:

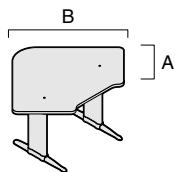

Dual Corner, Straight-Front Worksurfaces

24"	42"	BCKDC42P	\$2286
24"	48"	BCKDC48P	\$2326
:	:	:	:

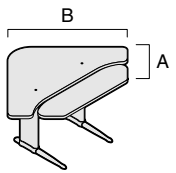

Bi-Level Corner, Straight-Front Worksurfaces

24"	42"	BCKBC42P	\$2286
24"	48"	BCKBC48P	\$2326
:	:	:	:

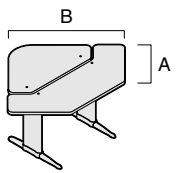

30" Radius Corner, Straight-Front Worksurfaces

24"	42"	BCKSC42P	\$1686
24"	48"	BCKSC48P	\$1726
:	:	:	:

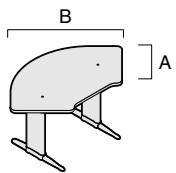

▶ Specification information continued on next page

► Specification information continued

Specification Information

• Planning Dimensions		• Style Number	• Base Price
A	B		

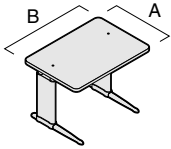

Straight Worksurfaces

30"	42"	BCKSS42P	\$1556
30"	48"	BCKSS48P	\$1581
:	:	:	:

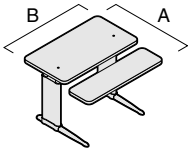

Dual Straight Worksurfaces

36"	42"	BCKDS42P	\$2156
36"	48"	BCKDS48P	\$2181
:	:	:	:

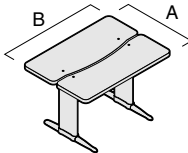

Bi-Level Straight Worksurfaces

36"	42"	BCKBS42P	\$2156
36"	48"	BCKBS48P	\$2181
:	:	:	:

Tip: Gas cylinder package can be field-installed to single and dual crank adjustable worksurfaces to provide additional lift.

Pair of Gas Cylinders

		ADJHTGASCYL	\$ 150
:	:	:	:

Adjustable-Height Worksurfaces

Laminate, with Electrically Adjustable Column Support

SIN 711.1

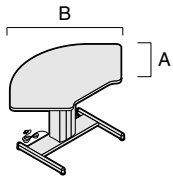

Tip: Adjustable-height work-surfaces are available in laminate only.

Tip: Adjustable-height mechanism requires assembly and attachment to the work surface.

Tip: 48" dual corner work-surfaces can support both a keyboard and a mouse pad on the same surface.

Standard Includes		Required to Specify	
<ul style="list-style-type: none"> • Worksurface: laminate • Vinyl P-edge profile on all sides: plastic • Drawer-mounted two-button controller • Adjustable-height column mechanism and base: paint price group 1 • 9' power cord: black vinyl only • Attachment hardware 		<ol style="list-style-type: none"> 1 Style number 2 Laminate color number for worksurface 3 Plastic color number for edge 4 Paint color number for column and base 5 Options, if selected (see below) <p>▶ See <i>Surface Materials</i>, page D102.</p>	
Surface Materials	Options	Price	Required to Specify
	<ul style="list-style-type: none"> • Paint price group 1 • Paint price group 2 • Paint price group 3 • Accent laminate • Open Line laminate 	No cost +\$ 34 +\$ 58 +\$ 60 +\$ 60 plus cost of laminate	Specify paint color number. Specify paint color number. Specify paint color number. ▶ See <i>Surface Materials Reference Manual</i> . ▶ See <i>Surface Materials Reference Manual</i> .
Programmable Memory	<ul style="list-style-type: none"> • Drawer-mounted six-button controller with 3x3 programmable memory and soft-start/soft-stop 	+\$299	Specify with <i>SSM</i> .
High-Performance Adjustable-Height Worksurface with Programmable Memory	<ul style="list-style-type: none"> • 250 pound weight capacity and drawer-mounted six-button controller with 3x3 programmable memory and soft-start/soft-stop 	+\$699	Specify with <i>250SSM</i> .

Specification Information

Planning Dimensions		Style Number	Base Price
A	B		

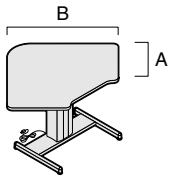

Corner, Straight-Front Worksurfaces

24"	42"	BECSC42P	\$2068
24"	48"	BECSC48P	\$2108
:	:	:	:

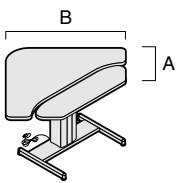

Dual Corner, Straight-Front Worksurfaces

24"	42"	BECD42P	\$2668
24"	48"	BECD48P	\$2708
:	:	:	:

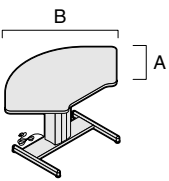

30° Radius Corner, Straight-Front Worksurfaces

24"	42"	BBECSC42P	\$2068
24"	48"	BBECSC48P	\$2108
:	:	:	:

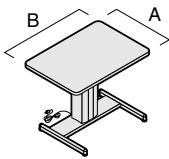

Straight Worksurfaces

30"	42"	BECSS42P	\$1938
30"	48"	BECSS48P	\$1963
:	:	:	:

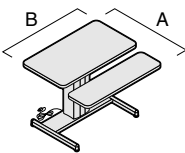

Dual Straight Worksurfaces

36"	42"	BECD42P	\$2538
36"	48"	BECD48P	\$2563
:	:	:	:

Worksurfaces

Legs and Tether Bracket

for Freestanding Worksurfaces

SIN 711.1

Cabby Legs

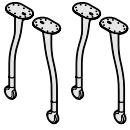

Tip: Illustration above shows legs with casters.



Tip: Illustration above shows legs with optional glides.

Tip: Corner worksurfaces require a leg in the back corner. Be sure to order fifth leg if specifying a package of four.

Tip: See Worksurface and Leg Combinations page for number of legs required per worksurface.

▶ See Answer Solutions Specification Guide.

Tip: Height of leg includes worksurface thickness.

Standard Includes	Required to Specify
<ul style="list-style-type: none"> • Worksurface legs: paint or metal • Locking casters: paint or metal default • Attachment hardware 	<ul style="list-style-type: none"> 1 Style number 2 Paint or metal color number for leg and caster 3 Options, if selected (see below) ▶ See <i>Surface Materials</i>, page D102.

Surface Materials	Options	Price	Required to Specify
	<ul style="list-style-type: none"> • Paint price group 1 • Paint price group 2 • Polished Chrome 	<ul style="list-style-type: none"> No cost +\$ 17 per leg +\$104 per leg 	<ul style="list-style-type: none"> Specify paint color number. Specify paint color number. Specify with 9201 Polished Chrome.
	Casters and Glides <ul style="list-style-type: none"> • One cabby leg • One glide 	<ul style="list-style-type: none"> No cost 	<ul style="list-style-type: none"> Specify with glide.
	Package of four cabby legs <ul style="list-style-type: none"> • Four glides • Two glides and two locking casters 	<ul style="list-style-type: none"> No cost No cost 	<ul style="list-style-type: none"> Specify with four glides. Specify with two glides and two locking casters.

Specification Information		
• Planning Height	• Style Number	• Base Price

One Cabby Leg

26"	DLNCAB26S	\$106
28½"	DLNCAB28S	\$106

Package of Four Cabby Legs

26"	DLNCAB264	\$424
28½"	DLNCAB284	\$424

Elliptical Legs

with Alignment Tab

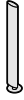

Tip: Use 26"H legs for nesting capabilities and use 28½"H legs to achieve standard height worksurfaces.

Standard Includes	Required to Specify
<ul style="list-style-type: none"> • Worksurface leg: paint or metal • Glides: paint or metal • Attachment hardware 	<ol style="list-style-type: none"> 1 Style number 2 Paint or metal color number for leg 3 Paint or metal color number for glides 4 Options, if selected (see below) <p>▶ See <i>Surface Materials</i>, page D102.</p>

Options	Price	Required to Specify
Surface Materials <ul style="list-style-type: none"> • Elliptical legs • Black • Platinum • Polished Chrome 	<ul style="list-style-type: none"> No cost No cost +\$70 	<ul style="list-style-type: none"> Specify with 7207 Black paint. Specify with 7604 Platinum. Specify with 9201 Polished Chrome.
<ul style="list-style-type: none"> • Glides • Black • Brushed Aluminum • Polished Aluminum 	<ul style="list-style-type: none"> No cost No cost No cost 	<ul style="list-style-type: none"> Specify with 7207 Black paint. Specify with 8042 Brushed Aluminum. Specify with 8046 Polished Aluminum.

Specification Information		
Planning Height	Style Number	Base Price
26"	BEL25	\$128
28½"	BEL27	\$144
.	.	.

Tip: Height of leg includes worksurface thickness.

Worksurfaces

Legs and Tether Bracket for Freestanding Worksurfaces, continued

SIN 711.1

Post Legs and Double Post C-Leg

with Alignment Tab

Tip: See Worksurface and Leg Combinations page for number of legs required per worksurface.

▶ See Answer Solutions Specification Guide.

Standard Includes	Required to Specify
-------------------	---------------------

- | | |
|--|--|
| <ul style="list-style-type: none"> • Worksurface legs: paint • Attachment hardware • Caster, if selected: black plastic only <ul style="list-style-type: none"> —One post leg: non-locking caster —Package of four post legs: four non-locking casters | <ul style="list-style-type: none"> 1 Style number 2 Paint color number for legs. 3 Options, if selected (see below) ▶ See <i>Surface Materials</i>, page D102. |
|--|--|

Options	Price	Required to Specify
---------	-------	---------------------

Surface Materials <ul style="list-style-type: none"> • Paint price group 1 • Paint price group 2 	No cost +\$17 per leg	Specify paint color number. Specify paint color number.
---	-----------------------------	--

Specification Information					
Height	Style Number	Base Price	Height	Style Number	Base Price

Tip: Height of leg includes worksurface thickness.

--	--	--	--	--	--

Single Post Leg with Alignment Tab

One Post Leg			Packages of Four		
26"	DLNANPS	\$ 62	26"	DLNANP4	\$248
28½"	DLNAPS	\$ 67	28½"	DLNAP4	\$268

Single Post Leg with Caster with Alignment Tab

One Post Leg			Packages of Four		
26"	DLNANPSC	\$ 73	26"	DLNANP4C	\$292
28½"	DLNAPSC	\$ 79	28½"	DLNAP4C	\$316

Double Post C-Leg with Alignment Tab

28½"	DLNAC	\$200
------	--------------	-------

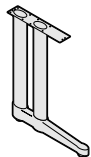
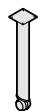
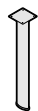

Tether Bracket

For Use with Pathways Post and Beam



Tip: Tether brackets must be specified when tethering a worksurface to Pathways Post and Beam.

Tip: Style number is for a single bracket.

Standard Includes	Required to Specify
-------------------	---------------------

- | | |
|---|--------------|
| <ul style="list-style-type: none"> • Bracket: 4799 Platinum paint only | Style number |
|---|--------------|

Specification Information	
Style Number	Price

BTTB	\$75

Specifying Workspace Screens



Statement of Line

D78



Specifying

Workspace Screens (SIN 711.1)

D79

Workspaces

Worksurface Screens

Statement of Line

24"H Laminae Screen

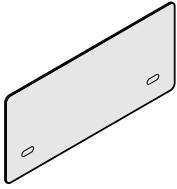

Specifying
▶ Page D79

	36"W	42"W	48"W	54"W
24"H	●	●	●	●

15"H Laminae Screen

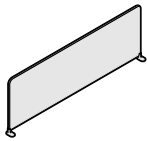

Specifying
▶ Page D79

	24"W	30"W	36"W	42"W
15"H	●	●	●	●

15"H Knit Screen

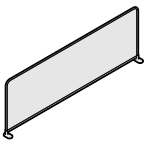

Specifying
▶ Page D79

	24"W	30"W	36"W	42"W
15"H	●	●	●	●

SIN 711.1

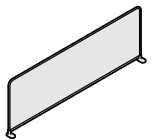
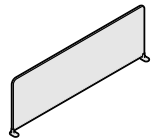
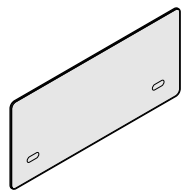
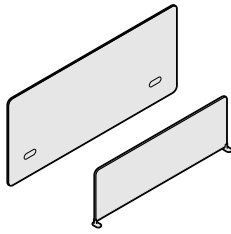

Tip: Attachment clamps are not included with screens. Clamps must be specified separately.

Standard Includes	Required to Specify
-------------------	---------------------

- Screen: laminae or vertical surface fabric
- Back plate for 24"H screen: 4799 Platinum only
- Foot for 15"H laminae screen: 4799 Platinum only
- Frame and foot for 15"H knit screen: 4799 Platinum only
- Attachment clamps: 4799 Platinum only
- Adjustment knob for clamp: 7237 Slate only
- Cover for clamp: 7237 Slate only

- 1 Style number
- 2 Laminae or vertical surface fabric color number for screen
- ▶ See *Surface Materials*, page D102.

Specification Information		
Width	Style Number	Price

24"H Laminae Screen

36"	DAP36	\$260
42"	DAP42	\$280
48"	DAP48	\$300
54"	DAP54	\$320
.	.	.

15"H Laminae Screen

24"	DALP24	\$173
30"	DALP30	\$188
36"	DALP36	\$203
42"	DALP42	\$218
.	.	.

15"H Knit Screen

24"	DALK24	\$173
30"	DALK30	\$188
36"	DALK36	\$203
42"	DALK42	\$218
.	.	.

Pair of Attachment Clamps for Worksurface

	DSCLAMP	\$100
.	.	.

Specifying Worksurface Power and Communication

Includes Internode and Wiring and Cabling Accessories

Specifying

Internode Power and Communication Components

Floor Power Infeeds (SIN 711.1)	D82
Multipurpose Power Infeeds (SIN 711.1)	D83
Beltway Power Outfeeds (SIN 711.1)	D84
Power Modules (SIN 711.1)	D85
Modular Harnesses (SIN 711.1)	D86
Receptacles (SIN 711.1)	D88
Convenience Tri-Receptacles with Modular Harness (SIN 711.1)	D89
Convenience Tri-Receptacle with Power Cord and Plug (SIN 711.1)	D90
Communication Module (SIN 711.1)	D90
Convenience Communication Outlet Housing (SIN 711.1)	D90
Above-Worksurface Clamp Kit (SIN 711.1)	D91
Below-Worksurface Mounting Bracket (SIN 711.1)	D91
Mounting Bracket (SIN 711.1)	D92
Cord and Cable Manager (SIN 711.1)	D92
Harness Clips (SIN 711.1)	D92

Wiring and Cabling Accessories

Power Spheres (SIN 711.1)	D93
Power and Communication Spheres (SIN 711.1)	D93
Communication Sphere (SIN 711.1)	D94
Power and Communication Port (SIN 711.1)	D94
Power Strips (SIN 711.1)	D94
Power/Data Boxes (SIN 711.1)	D95
Field-Installed Round Grommet (SIN 711.1)	D95
Answer Worksurface Wire Manager (SIN 711.1)	D96
Vertebral Cable Riser and Extension (SIN 711.1)	D96
Skeleton Bone Wire Managers (SIN 711.1)	D97
Cable and Fiber Reel (SIN 711.1)	D97
Termination Plate (SIN 711.1)	D97
Cord Reel (SIN 711.1)	D98
Cable Storage Tray (SIN 711.1)	D98
Wire Guide Clip (SIN 711.1)	D98
Wire Clip (SIN 711.1)	D99
Velcro Wire Clip (SIN 711.1)	D99
Post Leg Wire Manager (SIN 711.1)	D99
Wire Manager (SIN 711.1)	D100
Ganging Bracket for Tables (SIN 711.1)	D100

Internode Power and Communication Components

SIN 711.1

Floor Power Infeeds

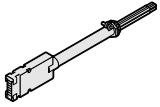

Tip: Floor power infeed cannot be used in New York City. Use a multipurpose power infeed instead.

Standard Includes	Required to Specify
<ul style="list-style-type: none"> • Junction box fittings for hardwired connection • Liquid-tight flexible conduit: black vinyl 	Style number

Specification Information

Length	Style Number	Price
--------	--------------	-------

4-Circuit, 3+1

6'	GFUFFH6X	\$162
12'	GFUFFH12X	\$216
:	:	:

4-Circuit, 2+2

6'	GFUFFH6Y	\$162
12'	GFUFFH12Y	\$216
:	:	:

3-Circuit, Separate Neutrals

6'	GFUFFH6Z	\$162
12'	GFUFFH12Z	\$216
:	:	:

Multipurpose Power Infeeds

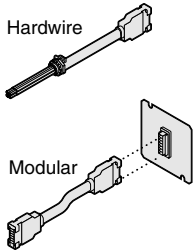

Tip: Modular connector receptacle covers a standard 4⁹/₁₆" square junction box.

Tip: Municipal building codes vary. Review installation requirements with local inspector prior to installation to ensure all guidelines are met.

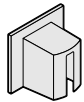

Standard Includes	Required to Specify
<ul style="list-style-type: none"> • Junction box fittings for hardwired connection, if selected • Modular connector, if selected • Modular connector receptacle included with modular option • Modular infeed cover, if selected: plastic • Conduit: metal 	<ul style="list-style-type: none"> 1 Style number 2 Plastic color number for modular infeed cover, if selected <p>▶ See <i>Surface Materials</i>, page D102.</p>

Specification Information

Length and Connection	Style Number	Price
-----------------------	--------------	-------

4-Circuit, 3+1

12' Hardwire	GSGUFMH12X	\$243
12' Modular	GSGUFMM12X	\$311
24' Hardwire	GSGUFMH24X	\$352
24' Modular	GSGUFMM24X	\$419
.	.	.

4-Circuit, 2+2

12' Hardwire	GSGUFMH12Y	\$243
12' Modular	GSGUFMM12Y	\$311
24' Hardwire	GSGUFMH24Y	\$352
24' Modular	GSGUFMM24Y	\$419
.	.	.

3-Circuit, Separate Neutrals

12' Hardwire	GSGUFMH12Z	\$243
12' Modular	GSGUFMM12Z	\$311
24' Hardwire	GSGUFMH24Z	\$352
24' Modular	GSGUFMM24Z	\$419
.	.	.

Modular Infeed Cover

N.A.	GSGUFC	\$ 31
.	.	.

SIN 711.1

Beltway Power Outfeeds

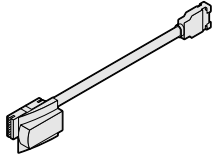

Tip: Beltway power outfeed cover and tri-receptacle are always the same color.

Standard Includes	Required to Specify
<ul style="list-style-type: none"> • 72" harness: metallic • Modular connector to attach to receptacle location in beltway: plastic • Modular connector to attach to power module 	<ul style="list-style-type: none"> 1 Style number 2 Plastic color number for modular connector ▶ See <i>Surface Materials</i>, page D102.

Specification Information

Style Number	Price
4-Circuit, 3+1	
GFUBFM6X	\$189
4-Circuit, 2+2	
GFUBFM6Y	\$189
3-Circuit, Separate Neutrals	
GFUBFM6Z	\$189

Power Modules

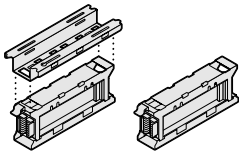

Tip: Remember to specify receptacles separately.
▶ Page D88

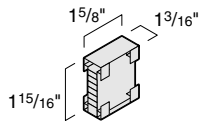

Standard Includes	Required to Specify
<ul style="list-style-type: none"> Power block and enclosing housing: 4793 Solar Black only Four modular receptacle attachment points Mounting bracket, if selected: 6653 Solar Black only Two covers: 6653 Solar Black only 	<ul style="list-style-type: none"> Style number

Related Products
<ul style="list-style-type: none"> Mounting bracket ▶ Page D92 Receptacles ▶ Page D88

Specification Information

Dimensions	Includes Mounting Bracket	Style Number	U.S.
D W H			

4-Circuit, 3+1

3"	10"	3 1/2"	Yes	GFUPMBX	\$203
3"	10"	3 1/2"	No	GFUPMX	\$176

Block-to-Block Connector

1 7/8"	1 5/8"	1 15/16"	N.A.	GSGUBCX	\$ 41
--------	--------	----------	------	----------------	-------

For Use in New York City

3"	10"	3 1/2"	Yes	GFUPMBXNYC	\$203
3"	10"	3 1/2"	No	GFUPMXNYC	\$176
:	:	:	:	:	:

4-Circuit, 2+2

3"	10"	3 1/2"	Yes	GFUPMBY	\$203
3"	10"	3 1/2"	No	GFUPMY	\$176

Block-to-Block Connector

1 3/16"	1 5/8"	1 15/16"	N.A.	GSGUBCY	\$ 41
---------	--------	----------	------	----------------	-------

For Use in New York City

3"	10"	3 1/2"	Yes	GFUPMBYNYC	\$203
3"	10"	3 1/2"	No	GFUPMYNYC	\$176
:	:	:	:	:	:

3-Circuit, Separate Neutrals

3"	10"	3 1/2"	Yes	GFUPMBZ	\$203
3"	10"	3 1/2"	No	GFUPMZ	\$176

Block-to-Block Connector

1 3/16"	1 5/8"	1 15/16"	N.A.	GSGUBCZ	\$ 41
---------	--------	----------	------	----------------	-------

For Use in New York City

3"	10"	3 1/2"	Yes	GFUPMBZNYC	\$203
3"	10"	3 1/2"	No	GFUPMZNYC	\$176
:	:	:	:	:	:

Worksurfaces

SIN 711.1

Modular Harnesses

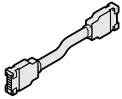

Tip: Modular-to-hardwire harnesses, modular lighting harnesses, and in-line switch harnesses work on Line 1 only.

Standard Includes	Required to Specify
• Harness	Style number

Specification Information

Length	Description	Style Number	Price
--------	-------------	--------------	-------

4-Circuit, 3+1

12"		GSGUH12X	\$ 95
22"		GSGUH22X	\$ 95
28"		GSGUH28X	\$ 95
32"		GSGUH32X	\$ 95
38"		GSGUH38X	\$ 95
44"		GSGUH44X	\$108
50"		GSGUH50X	\$108
54"		GSGUH54X	\$108
64"		GSGUH64X	\$122
76"		GSGUH76X	\$135
88"		GSGUH88X	\$149
100"		GSGUH100X	\$162
120"		GSGUH120X	\$189
144"		GSGUH144X	\$216

Harness-to-Harness Connector

		GSGUHCX	\$ 41
--	--	----------------	-------

Modular-to-Hardwire Harnesses

72"	Modular/Hardwire	GSGUHXX	\$122
-----	------------------	----------------	-------

In-Line Switch Harnesses

72"	Switch	GSGUHSX	\$135
-----	--------	----------------	-------

4-Circuit, 2+2

12"		GSGUH12Y	\$ 95
22"		GSGUH22Y	\$ 95
28"		GSGUH28Y	\$ 95
32"		GSGUH32Y	\$ 95
38"		GSGUH38Y	\$ 95
44"		GSGUH44Y	\$108

► **Specification Information continued on next page**

► **Specification Information, continued**

Specification Information

Length	Description	Style Number	Price
--------	-------------	--------------	-------

4-Circuit, 2+2, continued

50"		GSGUH50Y	\$108
54"		GSGUH54Y	\$108
64"		GSGUH64Y	\$122
76"		GSGUH76Y	\$135
88"		GSGUH88Y	\$149
100"		GSGUH100Y	\$162
120"		GSGUH120Y	\$189
144"		GSGUH144Y	\$216

Harness-to-Harness Connector

		GSGUHCY	\$ 41
--	--	----------------	-------

Modular-to-Hardwire Harnesses

72"	Modular/Hardwire	GSGUHHY	\$122
-----	------------------	----------------	-------

In-Line Switch Harnesses

72"	Switch	GSGUHSY	\$135
:	:	:	:

3-Circuit, Separate Neutrals

12"		GSGUH12Z	\$ 95
22"		GSGUH22Z	\$ 95
28"		GSGUH28Z	\$ 95
32"		GSGUH32Z	\$ 95
38"		GSGUH38Z	\$ 95
44"		GSGUH44Z	\$108
50"		GSGUH50Z	\$108
54"		GSGUH54Z	\$108
64"		GSGUH64Z	\$122
76"		GSGUH76Z	\$135
88"		GSGUH88Z	\$149
100"		GSGUH100Z	\$162
120"		GSGUH120Z	\$189
144"		GSGUH144Z	\$216

Harness-to-Harness Connector

		GSGUHCZ	\$ 41
--	--	----------------	-------

Modular-to-Hardwire Harnesses

72"	Modular/Hardwire	GSGUHHZ	\$122
-----	------------------	----------------	-------

In-Line Switch Harnesses

72"	Switch	GSGUHSZ	\$135
:	:	:	:

Worksurfaces

SIN 711.1

Receptacles

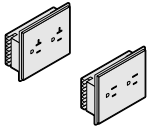

Tip: Receptacles are specified individually so you can order exactly the quantity you need.

Standard Includes	Required to Specify
<ul style="list-style-type: none"> Individual receptacles: plastic 	<ul style="list-style-type: none"> 1 Style number 2 Plastic color number for receptacle ▶ See <i>Surface Materials</i>, page D102.

Specification Information

Line	System Ground		Isolated Ground	
	Style Number	Price	Style Number	Price

4-Circuit, 3+1

15-amp Receptacles

Line 1	GSGUR1SSX	\$32	GSGUR1SGX	\$41
Line 2	GSGUR2SSX	\$32	GSGUR2SGX	\$41
Line 3	GSGUR3SSX	\$32	GSGUR3SGX	\$41
Line 4	GSGUR4SSX	\$32	GSGUR4SGX	\$41

20-amp Receptacles

Line 1	GSGUR1TSX	\$49	GSGUR1TGX	\$62
Line 2	GSGUR2TSX	\$49	GSGUR2TGX	\$62
Line 3	GSGUR3TSX	\$49	GSGUR3TGX	\$62
Line 4	GSGUR4TSX	\$49	GSGUR4TGX	\$62

4-Circuit, 2+2

15-amp Receptacles

Line 1	GSGUR1SSY	\$32	GSGUR1SGY	\$41
Line 2	GSGUR2SSY	\$32	GSGUR2SGY	\$41
Line 3	GSGUR3SSY	\$32	GSGUR3SGY	\$41
Line 4	GSGUR4SSY	\$32	GSGUR4SGY	\$41

20-amp Receptacles

Line 1	GSGUR1TSY	\$49	GSGUR1TGY	\$62
Line 2	GSGUR2TSY	\$49	GSGUR2TGY	\$62
Line 3	GSGUR3TSY	\$49	GSGUR3TGY	\$62
Line 4	GSGUR4TSY	\$49	GSGUR4TGY	\$62

3-Circuit, Separate Neutrals

15-amp Receptacles

Line 1	GSGUR1SSZ	\$32	GSGUR1SGZ	\$41
Line 2	GSGUR2SSZ	\$32	GSGUR2SGZ	\$41
Line 3	GSGUR3SSZ	\$32	GSGUR3SGZ	\$41

20-amp Receptacles

Line 1	GSGUR1TSZ	\$49	GSGUR1TGZ	\$62
Line 2	GSGUR2TSZ	\$49	GSGUR2TGZ	\$62
Line 3	GSGUR3TSZ	\$49	GSGUR3TGZ	\$62

Convenience Tri-Receptacles with Modular Harness

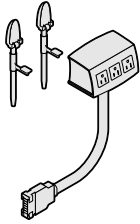

Standard Includes	Required to Specify
<ul style="list-style-type: none"> • Convenience tri-receptacle with three outlets: plastic • Harness with modular connector for attachment to end of power module • Conduit: metallic • Mounting clamp kit 	<ul style="list-style-type: none"> 1 Style number 2 Plastic color number for receptacle 3 Options, if selected (see below) ▶ See <i>Surface Materials</i>, page D102.

Options	Price	Required to Specify
Outfeed <ul style="list-style-type: none"> • Beltway power outfeed connector with cover that matches receptacle color 	+\$21	▶ Specify <i>with beltway power outfeed connector</i> .

Specification Information

Harness Length	Line	Style Number	Base Price	Style Number	Base Price
----------------	------	--------------	------------	--------------	------------

4-Circuit, 3+1

With System Ground				With Isolated Ground	
72"	Line 1	GFUT1S72X	\$149	GFUT1G72X	\$149
	Line 2	GFUT2S72X	\$149	GFUT2G72X	\$149
	Line 3	GFUT3S72X	\$149	GFUT3G72X	\$149
	Line 4	GFUT4S72X	\$149	GFUT4G72X	\$149

4-Circuit, 2+2

With System Ground				With Isolated Ground	
72"	Line 1	GFUT1S72Y	\$149	GFUT1G72Y	\$149
	Line 2	GFUT2S72Y	\$149	GFUT2G72Y	\$149
	Line 3	GFUT3S72Y	\$149	GFUT3G72Y	\$149
	Line 4	GFUT4S72Y	\$149	GFUT4G72Y	\$149

3-Circuit, Separate Neutrals

With System Ground				With Isolated Ground	
72"	Line 1	GFUT1S72Z	\$149	GFUT1G72Z	\$149
	Line 2	GFUT2S72Z	\$149	GFUT2G72Z	\$149
	Line 3	GFUT3S72Z	\$149	GFUT3G72Z	\$149

SIN 711.1

Convenience Tri-Receptacle with Power Cord and Plug



Tip: This unit does not include clamp kit.
▶ Page D91

Standard Includes **Required to Specify**

- Convenience receptacle with three outlets: plastic
 - 96" power cord with grounded plug: black only
- 1 Style number
 - 2 Plastic color number for receptacle
 - ▶ See *Surface Materials*, page D102.

Related Products

- Above-worksurface clamp kit ▶ Page D91
- Below-worksurface mounting bracket ▶ Page D91

Specification Information

• Dimensions			• Style	• Price
D	W	H	Number	
2¾"	5¼"	2½"	GFUTP96	\$81

Communication Module

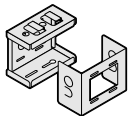

Tip: Communication module can be attached to a power module, mounting bracket, or directly onto the underside of a worksurface.

Standard Includes **Required to Specify**

- Two-piece communication module: 4793 Solar Black only
 - One cover, used to adapt NEMA opening to modular furniture faceplate opening
- Style number

Specification Information

• Dimensions			• Style	• Price
D	W	H	Number	
3"	5"	4"	GFUSCM	\$41

Convenience Communication Outlet Housing



Tip: This unit does not include clamp kit.
▶ Page D91

Tip: Convenience communication outlet housing can be connected to convenience tri-receptacles side by side.

Standard Includes **Required to Specify**

- Housing for field-installed modular communications faceplate: plastic
- 1 Style number
 - 2 Plastic color number for housing
 - ▶ See *Surface Materials*, page D102.

Related Products

- Above-worksurface clamp kit ▶ Page D91
- Below-worksurface mounting bracket ▶ Page D91

Specification Information

• Dimensions			• Style	• Price
D	W	H	Number	
2¾"	5¼"	2½"	GFUCH	\$41

Above-Worksurface Clamp Kit

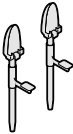

Standard Includes	Required to Specify
<ul style="list-style-type: none"> • Mounting clamp to secure convenience tri-receptacle to worksurface: 6653 Solar Black only 	Style number

Related Products	
<ul style="list-style-type: none"> • Convenience tri-receptacles with modular harness • Convenience tri-receptacle with power cord • Convenience communication outlet housing 	<ul style="list-style-type: none"> ▶ Page D89 ▶ Page D90 ▶ Page D90

Specification Information	
• Style Number	• Price
GFUTMC	\$14

Below-Worksurface Mounting Bracket

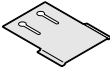

Tip: Mounting bracket supports convenience tri-receptacles and convenience communication outlet housing below the worksurface.

Tip: Each tri-receptacle, whether power or communications, should have its own mounting bracket for below-worksurface mounting applications.

Standard Includes	Required to Specify
<ul style="list-style-type: none"> • Mounting bracket: 4793 Solar Black only 	Style number

Related Products	
<ul style="list-style-type: none"> • Convenience tri-receptacles with modular harness • Convenience tri-receptacle with power cord • Convenience communication outlet housing 	<ul style="list-style-type: none"> ▶ Page D89 ▶ Page D90 ▶ Page D90

Specification Information	
• Style Number	• Price
GFUTMB	\$10

SIN 711.1

Mounting Bracket

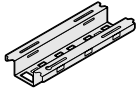

Tip: Mounting bracket supports either a communication module or a power module.

Standard Includes		Required to Specify
<ul style="list-style-type: none"> Mounting bracket: 4793 Solar Black only 		Style number
Specification Information		
Style Number	Price	
GFUMB	\$27	

Cord and Cable Manager

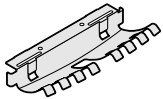

Standard Includes		Required to Specify		
<ul style="list-style-type: none"> Cord and cable manager: 6653 Solar Black only Package of four 		Style number		
Specification Information				
Dimensions			Style Number	Price
D	W	H		
3 1/2"	10"	1 3/4"	GFUCCM	\$81

Harness Clips



Standard Includes		Required to Specify
<ul style="list-style-type: none"> Package of 25 harness clips with screws: black only 		Style number
Specification Information		
Diameter	Style Number	Price
1 1/4"	GFUCMC	\$27

SIN 711.1

Power Spheres

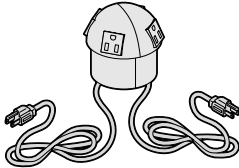

Tip: Sphere is field installed. Use 3"-diameter drill to cut mounting hole at desired location.

Standard Includes				Required to Specify	
<ul style="list-style-type: none"> Sphere with four simplex electrical outlets: black plastic only Two 6' power cords (each rated at 15 amps), if selected: black plastic only Two 6' Greenfield conduits (each rated at 15 amps), if selected: metal only 				Style number	
Specification Information					
Dimensions			Style	Price	
D	W	H	Number		
Four Electrical Outlets with Two 6' Power Cords					
3 ³ / ₈ "	3 ³ / ₈ "	3"	PTDMGB1	\$164	
Four Electrical Outlets with Two 6' Greenfield Conduits for Hardwiring					
3 ³ / ₈ "	3 ³ / ₈ "	3"	PTDMGB2	\$283	

Worksurfaces

Power and Communication Spheres

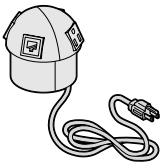

Tip: Sphere is field installed. Use 3"-diameter drill to cut mounting hole at desired location.

Tip: Face plates in sphere accommodates standard voice/data jacks.

Standard Includes				Required to Specify	
<ul style="list-style-type: none"> Sphere with two simplex electrical outlets: black plastic only Face plates to accommodate two customer-supplied voice/data jacks: black plastic only 6' power cord with plug rated at 15 amps, if selected: black plastic only 6' Greenfield conduit for hardwiring, if selected: metal only 				Style number	
Specification Information					
Dimensions			Style	Price	
D	W	H	Number		
Sphere with One 6' Power Cord					
3 ³ / ₈ "	3 ³ / ₈ "	3"	PTDMGB3	\$164	
Sphere with One 6' Greenfield Conduit for Hardwiring					
3 ³ / ₈ "	3 ³ / ₈ "	3"	PTDMGB4	\$232	

SIN 711.1

Communication Sphere



Tip: Sphere is field installed. Use 3"-diameter drill to cut mounting hole at desired location.

Tip: Face plates in sphere accommodates standard voice/data jacks.

Standard Includes	Required to Specify
<ul style="list-style-type: none"> Sphere with face plates to accommodate four customer-supplied voice/data jacks: black plastic only 	Style number

Specification Information

• Dimensions			• Style	• Price
D	W	H	Number	
3 3/8"	3 3/8"	3"	PTDMGB5	\$164

Power and Communication Port

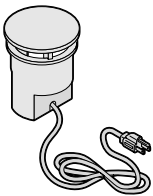

Tip: Port is field installed. Use a 3 1/2"-diameter drill to cut mounting hole at desired location.

Standard Includes	Required to Specify
<ul style="list-style-type: none"> Port with two electrical outlets: black plastic only 6' power cord with plug rated at 15 amps: black plastic only Adapters for two customer-supplied data couplers/jacks 	Style number

Specification Information

• Dimensions			• Style	• Price
D	W	H	Number	
4 1/4"	4 1/4"	4 5/16"	PTRSGB1	\$256

Power Strips

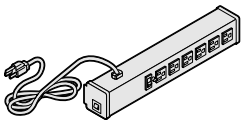

Standard Includes	Required to Specify
<ul style="list-style-type: none"> Power strip with 6' cord and three-prong plug: Grey Value 5 paint only 	Style number

Specification Information

• Style Number	• Price
Without Line Conditioner	
88PS	\$ 68
With Line Conditioner	
88PSLC	\$171

Power/Data Boxes

Standard Includes	Required to Specify
<ul style="list-style-type: none"> • Power/data box • Power/power box • Data/data box 	Style number

Specification Information

Dimensions			Style	Price
D	W	H	Number	
:	:	:	:	:

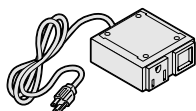

Power/Data Box				
3"	3"	1"	GVDPBOX	\$150
:	:	:	:	:

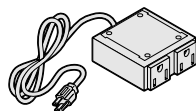

Power/Power Box				
3"	3"	1"	GVPPBOX	\$150
:	:	:	:	:

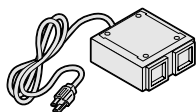

Data/Data Box				
3"	3"	1"	GVDDBOX	\$150
:	:	:	:	:

Field-Installed Round Grommet



Tip: Grommet PTGRMT is for use on worksurfaces only.

Standard Includes	Required to Specify
<ul style="list-style-type: none"> • Grommet: paint or metal • Installation instructions 	1 Style number 2 Paint or metal color number ▶ See <i>Surface Materials</i> , page D102.

Specification Information

Dimensions			Style	Price
D	W		Number	
:	:	:	:	:

2½"	2½"		PTGRMT	\$50
:	:	:	:	:

SIN 711.1

Answer Worksurface Wire Manager



Standard Includes	Required to Specify
<ul style="list-style-type: none"> • Set of six field installed worksurface wire managers: plastic • Attachment hardware 	1 Style number 2 Plastic color number for worksurface wire manager: 6000 Black 6654 Sand (Vanadium) 6695 Midnight 6697 Fog

Specification Information	
• Style Number	• Price
TS7WWM	\$59

Vertebral Cable Riser and Extension

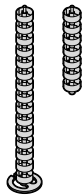

Standard Includes	Required to Specify
<ul style="list-style-type: none"> • Vertebral cable riser: black plastic only • Attachment hardware • Floor plate: Metallic Aluminum only 	Style number

Specification Information		
• Length	• Style Number	• Price

Vertebral Cable Riser		
31½"	DAVC	\$97

Vertebral Cable Riser Extension		
15¾"	DAVCE	\$28

Tip: 15¾"L cable riser is an extension only. Extension does not include attachment hardware or floor plate.

Skeleton Bone Wire Managers

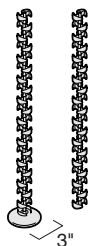

Note: This product is Turnstone, **NOT** Steelcase. It is included here to simplify your planning. Remember that Steelcase has different pricing terms than Turnstone products.

Standard Includes	Required to Specify
-------------------	---------------------

- Wire manager: black plastic
- Attachment hardware

Style number

Specification Information				
• Dimensions			• Style	• Price
D	W	H	Number	

D	W	H	Style Number	Price
---	---	---	--------------	-------

Skeleton Bone Wire Manager				
----------------------------	--	--	--	--

1½"	1¾"	38"	TS5SKLBNE	\$94
-----	-----	-----	------------------	------

Skeleton Bone Wire Manager Extension				
--------------------------------------	--	--	--	--

1½"	1¾"	36"	TS5SKEXT	\$75
-----	-----	-----	-----------------	------

Cable and Fiber Reel

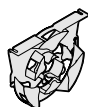

Standard Includes	Required to Specify
-------------------	---------------------

- Package of four reels: black plastic only

Style number

Specification Information	
• Style Number	• Price

98766	\$87
--------------	------

Termination Plate



Standard Includes	Required to Specify
-------------------	---------------------

- Termination plate: black paint only

Style number

Specification Information				
• Dimensions			• Style	• Price
D	W	H	Number	

¾"	7⅛"	7⅛"	98765	\$14
----	-----	-----	--------------	------

SIN 711.1

Cord Reel

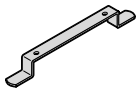

Standard Includes		Required to Specify
<ul style="list-style-type: none"> • Carton of six cord reels: black paint only 		Style number
Specification Information		
Style Number	Price	
98767	\$37	

Cable Storage Tray

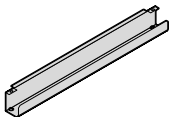

Standard Includes		Required to Specify		
<ul style="list-style-type: none"> • Cable storage tray: black paint only 		Style number		
Specification Information				
Dimensions			Style Number	Price
D	W	H		
2"	24"	2 1/2"	98768	\$28

Wire Guide Clip



Standard Includes		Required to Specify
<ul style="list-style-type: none"> • Carton of 20 adhesive-backed wire guide clips: black plastic only 		Style number
Specification Information		
Style Number	Price	
32WCP	\$21	

Wire Clip



Standard Includes	Required to Specify
<ul style="list-style-type: none"> • Carton of six: black plastic only • Foam tape • Mounting screws 	Style number

Specification Information

Style Number	Price
999CHT	\$35

Velcro Wire Clip



Tip: Attaches under work-surfaces with screws or around leg.

Note: This product is Turnstone, **NOT** Steelcase. It is included here to simplify your planning. Remember that Steelcase has different pricing terms than Turnstone products.

Standard Includes	Required to Specify
<ul style="list-style-type: none"> • Package of six wire clips: velcro • Attachment hardware 	Style number

Specification Information

Dimensions			Style Number	Price
D	W	H		
1/2"	8"	1/2"	TS5LEGCLP	\$33

Post Leg Wire Manager



Standard Includes	Required to Specify
<ul style="list-style-type: none"> • Package of 20 wire managers: black plastic only 	Style number

Specification Information

Style Number	Price
TS7LWM	\$30

SIN 711.1

Wire Manager

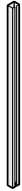

Standard Includes	Required to Specify
-------------------	---------------------

- | | |
|--|--------------|
| <ul style="list-style-type: none"> • 25" wire manager with double-sided tape: black plastic | Style number |
|--|--------------|

Specification Information				
---------------------------	--	--	--	--

• Dimensions			• Style	• Price
D	W	H	Number	
1"	3/4"	25"	PTWM25	\$12

Ganging Bracket for Tables

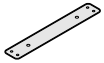

Note: This product is Turnstone, **NOT** Steelcase. It is included here to simplify your planning. Remember that Steelcase has different pricing terms from Turnstone products.

Standard Includes	Required to Specify
-------------------	---------------------

- | | |
|--|--------------|
| <ul style="list-style-type: none"> • Ganging bracket: black paint | Style number |
|--|--------------|

Specification Information			
---------------------------	--	--	--

• Dimensions		• Style	• Price
D	W	Number	
1 1/2"	9"	TS5GANGBKT	\$14

Surface Materials

Surface Materials	D102
Color Coordination Matrices	D104
Directional Laminate Grain Directions	D106
Wood Grain Directions	D108

Surface Materials

This listing includes all the surface material choices that are available for the products in this specification guide.

Paint

Applies to:

- Elliptical leg

4799 Platinum
7207 Black

Applies to:

- Cabby legs
- Post legs
- Double post C-legs
- Crank adjustable height worksurface
- Grommet adapter plates
- Consolidation point cabinet

Tip: For electrically adjustable height worksurfaces, transitional paints only are available.

▶ See *Transitional Products Specification Guide*.

Price Group 1

Textured Paint

7207 Black
7225 Sand (Vanadium)
7236 Fog
7237 Slate
7238 Fieldstone
7239 Midnight

Price Group 2

Metallic Paint

4750 Champagne
4751 Bronze
4752 Steel
4788 Gold Dust
4798 Sterling
4799 Platinum

Price Group 3

Accent Paint

Please see the Accent Paint swatchcard in the *Surface Materials Finishes Binder* for a complete list of these colorful paints.

Tip: Price Group 3 paints are not available on cabby legs.

PerfectMatch II Paint

PerfectMatch II paint is a service that allows you to create your own paint color. Refer to the *Surface Materials Reference Manual* for more information about this program.

Tip: The PerfectMatch II paint program is not available on cabby legs.

Metal

Applies to:

- Cabby legs
- Elliptical leg

9201 Polished Chrome

Laminate

Laminate Color Choices

Applies to:

- Universal Systems work-surfaces—laminate

Standard Laminate

2412 Natural Cherry
2422 Medium Cherry
2511 Winter on Maple
2592 Blonde on Maple
2632 Medium Oak
2714 Natural Walnut
2722 Cream
2729 White Sand
2730 Arctic White
2746 Black
2759 Warm White
2772 Medium Mahogany on Walnut
2810 Dawn
2811 Mist
2820 Coffee Speckle
2822 Woodrose Speckle
2823 Driftwood Speckle
2824 Smoke Speckle
2825 Vanadium Speckle
2850 Vanadium Fiber
2851 Rhyme Fiber
2852 Tungsten Fiber
2854 Vellum Fiber
2857 Stream Fiber
2859 Novell Fiber
2860 Granite Fiber
2870 Blonde Bronze Patina
2871 Blackened Bronze Patina
2872 Silver Plate Patina
2873 Instant Iron Patina

Accent Laminate

Accent laminates are available with an upcharge of \$60 U.S. or \$83 Canadian per worksurface. Please see the *Accent Laminate* swatch card within the *Steelcase Hard Finishes Binder* for a complete listing of these colorful laminates.

For additional information, refer to the *Steelcase Surface Materials Reference Manual*.

Open Line Laminate

This service allows you to order non-standard laminate at an additional processing fee of \$60 U.S. per worksurface, plus the cost of the laminate.

When processing orders for Open Line Laminate, specify 2900 in the laminate finish field and enter the OLL manufacturer information. Enter the required edge finish as you would a standard laminate.

For additional information, refer to the *Steelcase Surface Materials Reference Manual*.

Laminae

Applies to:

- Laminae screens

2101 Frost
2102 Bisque
2103 Dove
2104 Charcoal
2105 Fiesta
2106 Berry

Note: Laminae is not a markerboard surface and should not be written on with markers or dry-erase markers.

Vertical Surface Fabric

Applies to:

- Knit screens

B902 Soft White
B903 Fog
B904 Sand

Wood

Applies to:

- Universal Systems work-surfaces—wood veneer

Steelcase carefully selects veneer and solid wood or consistent color and grain structure. Wood is a natural material and variations will occur in color, grain, and texture. These variations are part of the inherent natural beauty of wood and are not considered defects.

All wood products will darken with age and exposure to ultraviolet light. This is especially apparent with cherry and maple veneer. We recommend that desk accessories be arranged periodically to ensure even aging of wood surfaces.

Veneers are flat cut and are matched for proper balance and consistency.

Open-pore finish is a medium-gloss finish that leaves the wood texture visible to the eye and distinguishable to the touch.

Open-pore finish choices

- 3412 Natural Cherry
- 3422 Medium Cherry
- 3562 Linseed on Maple
- 3572 Amber Maple on Maple
- 3582 Winter on Maple
- 3592 Blonde on Maple
- 3632 Medium Oak
- 3642 Natural Oak
- 3712 Natural Walnut
- 3722 Dark Mahogany on Walnut
- 3742 Autumn Walnut
- 3772 Medium Mahogany on Walnut
- 3792 Black Walnut

Full-fill finish is a medium-gloss finish that completely fills the grain texture, yet allows the grain pattern to be seen. The wood has a lustrous, satiny look and it is smooth to the touch. This finish is available on the wood work surface or top only.

Full-fill finish choices

- 3414 Natural Cherry
- 3424 Medium Cherry
- 3534 Winter on Maple
- 3544 Blonde on Maple
- 3564 Linseed on Maple
- 3574 Amber on Maple
- 3634 Medium Oak
- 3644 Natural Oak
- 3714 Natural Walnut
- 3724 Dark Mahogany on Walnut
- 3744 Autumn Walnut
- 3774 Medium Mahogany on Walnut
- 3794 Black Walnut

Customiz stain

Customiz stain is a service that allows you to create your own stain colors on standard veneers. Customiz stain color is available on all product lines that offer wood veneer.

A one-time formulation fee of \$400 U.S. per color, per customer processing fee will apply. The fee covers the cost of formulating the Customiz finish and applies regardless of whether or not an order for product is placed. Please refer to the "Customiz Stain" option price column in your specification guide for the unit upcharge.

Customiz stain takes 10 days to formulate. Consult the *Surface Materials Reference Manual* for more information. Custom veneers are also available and must be quoted by specials engineering. Customiz stain on custom veneers take two to four weeks to formulate.

Requirements and information on ordering a Customiz stain color are found in the *Surface Materials Reference Manual*.

Plastic

Applies to:

- 3 mm edge profile on Universal Systems laminate worksurfaces

- 6000 Black
- 6001 Coffee
- 6008 Bramble
- 6615 Grey V5
- 6619 Ice
- 6628 Tan V1
- 6631 Cream
- 6635 Dawn
- 6636 Mist
- 6654 Sand (Vanadium)
- 6655 Warm White
- 6694 Slate
- 6695 Midnight
- 6697 Fog
- 6698 Fieldstone

Applies to:

- P-edge profile on Universal Systems and Freestanding laminate worksurfaces

- 6000 Black
- 6654 Sand (Vanadium)
- 6694 Slate
- 6695 Midnight
- 6697 Fog
- 6698 Fieldstone

Note: Light color plastic edges are susceptible to degradation due to normal wear and tear. Staining (e.g. ball point pen) and dirt effects are more pronounced in light colors and are not considered defects.

Applies to:

- P-edge profile on Universal Freestanding wood veneer worksurfaces
- 6000 Black

Applies to:

- Receptacles
- Modular connector
- Modular infeed cover
- Cable entry housing
- Internode convenience communication outlet housing
- Internode beltway power outfeed

- Cable grommet
 - 6000 Black
 - 6625 Translucent
 - 6651 Tungsten
 - 6652 Titanium
 - 6653 Solar Black
 - 6654 Vanadium
 - 6656 Tantalum
 - 6681 Grotto
- Tip: Plastic components may not be available in all colors above.*

Dupont™ Corian

Steelcase – Dupont Corian – TFI Alliance

Steelcase now has an alliance with Dupont to provide Universal Freestanding Worksurfaces—Laminate made with Corian solid surfaces. These elegant tops are produced and sold exclusively by TFI, the industry leader in the development of products and processes with Dupont Corian. This program is available to authorized Steelcase dealers.

Use this specification guide to understand more about Freestanding Worksurfaces; pricing is available from TFI in the Steelcase Corian Binder. To order Corian, simply add "COR" to the suffix of the Freestanding Worksurface style number and fax the order directly to TFI.

Steelcase Corian Colors

Eight Corian colors have been selected which best suit the Steelcase surface materials color palette: Antarctica, Cameo White, Canyon, Linen, Riviera Mist, Shale, Vanilla, and Winter Frost samples can be ordered as a set.

For additional information regarding becoming an authorized dealer or to order literature and samples contact:

TFI
1600 Oak Street
Lakewood, NJ 08701
Phone: 866.834.6054
Fax: 732.363.9129

Color Coordination Matrices

Recommended Front Edge Colors for Universal Systems Worksurfaces—Laminate

Edges

The recommended edge color will compliment the laminate color you specify. Edge color is specified separately.

Laminate Color	Recommended 3 mm Edge Color	Recommended P-Edge Color
2412 Natural Cherry	6001 Coffee	6000 Black
2422 Medium Cherry	6001 Coffee	6000 Black
2511 Winter on Maple	6655 Warm White	6654 Sand
2592 Blonde on Maple	6655 Warm White	6654 Sand
2632 Medium Oak	6001 Coffee	6000 Black
2714 Natural Walnut	6001 Coffee	6000 Black
2722 Cream	6631 Cream	6654 Sand
2729 White Sand	6654 Sand	6654 Sand
2730 Arctic White	6697 Fog	6697 Fog
2746 Black	6000 Black	6000 Black
2759 Warm White	6655 Warm White	6654 Sand
2772 Medium Mahogany on Walnut	6001 Coffee	6000 Black
2810 Dawn	6635 Dawn	6000 Black
2811 Mist	6636 Mist	6697 Fog
2820 Coffee Speckle	6631 Cream	6654 Sand
2822 Woodrose Speckle	6635 Dawn	6000 Black
2823 Driftwood Speckle	6631 Cream	6000 Black
2824 Smoke Speckle	6636 Mist	6654 Sand
2825 Vanadium Speckle	6619 Ice	6697 Fog
2850 Vanadium Fiber	6654 Sand	6697 Fog
2851 Rhyme Fiber	6631 Cream	6654 Sand
2852 Tungsten Fiber	6636 Mist	6654 Sand
2854 Vellum Fiber	6655 Warm White	6697 Fog
2857 Stream Fiber	6636 Mist	6698 Fieldstone
2859 Novell Fiber	6001 Coffee	6697 Fog
2860 Granite Fiber	6000 Black	6000 Black
2870 Blonde Bronze Patina	6654 Sand	6654 Sand
2871 Blackened Bronze Patina	6615 Grey V5	6000 Black
2872 Silver Plate Patina	6619 Ice	6697 Fog
2873 Instant Iron Patina	6615 Grey V5	6000 Black

Directional Laminate Grain Directions

Directional laminates are standard with the grain directions shown.

Universal Systems Worksurfaces—Laminate

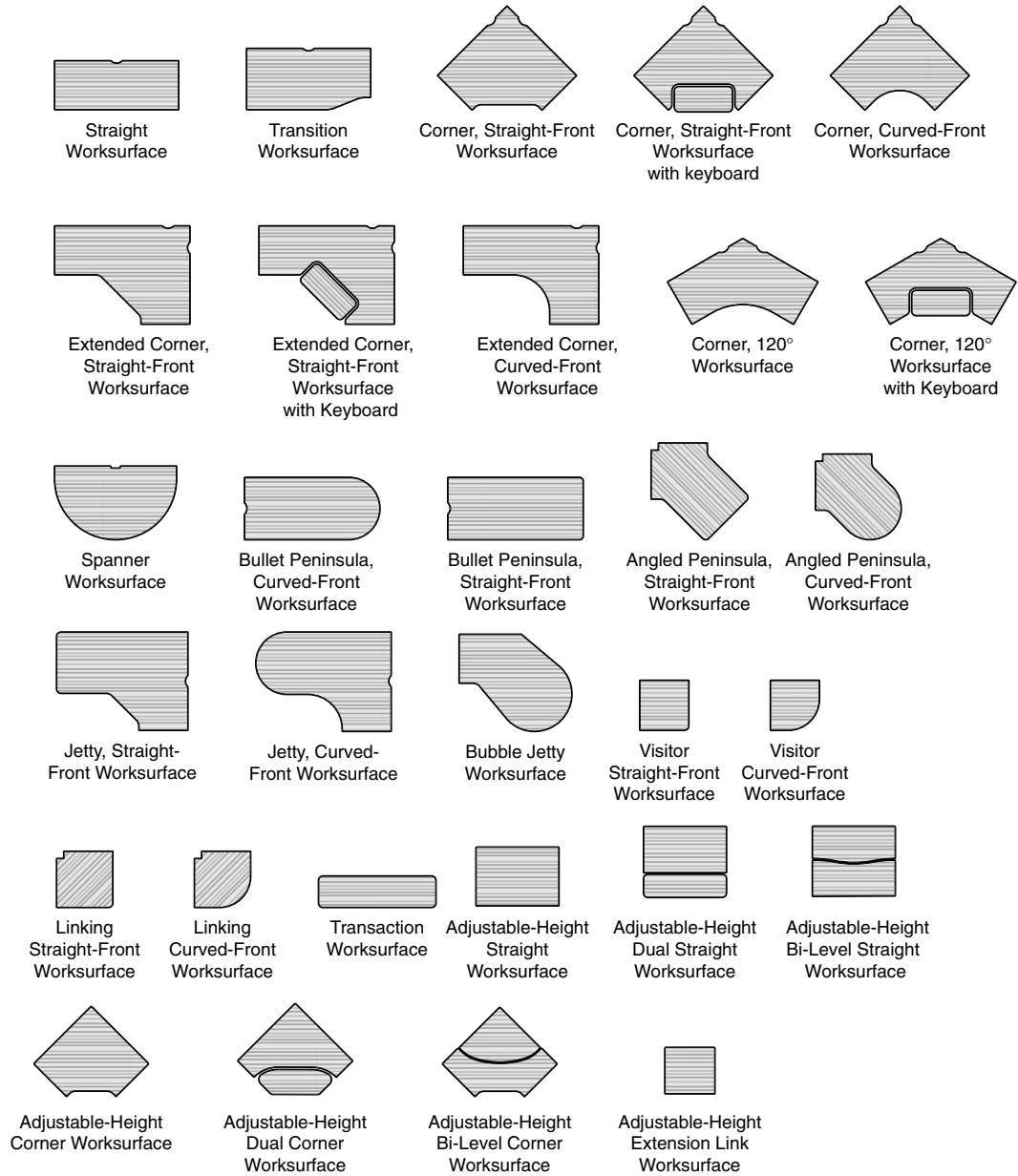

Universal Freestanding Worksurfaces—Laminate



Straight Worksurface



Transition Worksurface

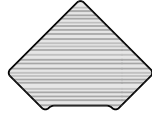

Corner, Straight-Front Worksurface

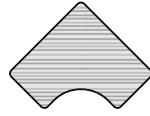

Corner, Curved-Front Worksurface



30° Radius Corner, Straight-Front Worksurface



30° Radius Corner, Curved-Front Worksurface

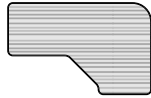

Extended Corner, Straight-Front Worksurface



Corner, 120° Worksurface



Capsule Worksurface



Spanner Worksurface



Hub Spanner Worksurface



Peninsula Worksurface

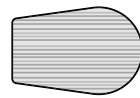

Tapered Peninsula Worksurface

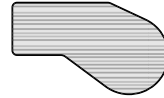

Bubble Jetty Worksurface



Round Worksurface



Square Worksurface



Rectangle Worksurface

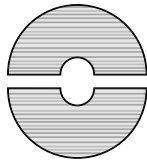

Split-Round Worksurface



Tethered Capsule Worksurface



Adjustable-Height Straight Worksurface

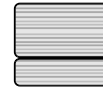

Adjustable-Height Dual Straight Worksurface

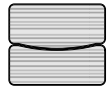

Adjustable-Height Bi-Level Straight Worksurface



Adjustable-Height Corner, Straight-Front Worksurface



Adjustable-Height Dual Corner, Straight-Front Worksurface



Adjustable-Height Bi-Level Corner, Straight-Front Worksurface



Adjustable-Height 30° Radius Corner, Straight-Front Worksurface

Wood Grain Directions

The appearance of wood veneer may change slightly depending on the angle from which it is viewed. This natural phenomenon is called polarization, and it can be seen on natural veneer. Polarization is often noticed on worksurfaces installed at a 90-degree angle with each other. Please refer to the following illustrations for an understanding of grain direction on your installation.

Universal Systems Worksurfaces—Wood Veneer

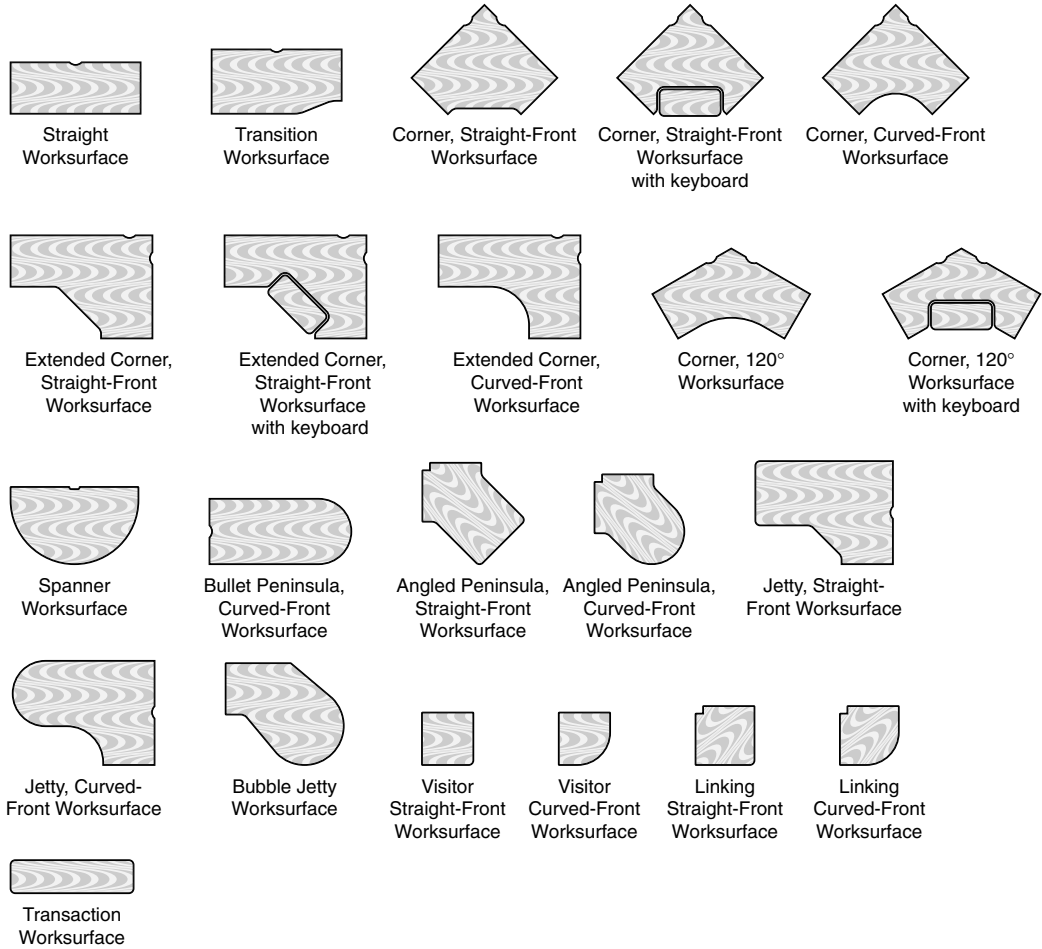

Universal Freestanding Worksurfaces—Wood Veneer

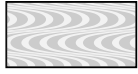

Straight
Worksurface

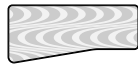

Transition
Worksurface



Corner, Straight-Front
Worksurface

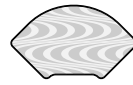

30° Radius Corner,
Straight-Front
Worksurface

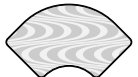

30° Radius Corner,
Curved-Front
Worksurface

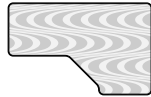

Extended Corner,
Straight-Front
Worksurface



Corner, 120°
Worksurface

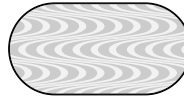

Capsule
Worksurface



Spanner
Worksurface



Peninsula
Worksurface

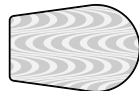

Tapered Peninsula
Worksurface



Bubble Jetty
Worksurface



Round
Worksurface



Square
Worksurface

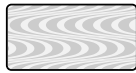

Rectangle
Worksurface

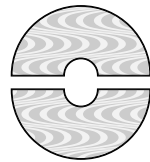

Split-Round
Worksurface

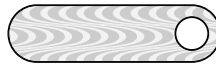

Tethered Capsule
Worksurface



Resources

Style Number Index

E2

Style Number Index

Style Number	Page	Description
130HF	B160	AN HF Folder Frame
136HF	B160	AN HF Folder Frame
142HF	B160	AN HF Folder Frame
32WCP	C144, C236, D98	Wire Guide Clips
800RW	B159	AN Adjustable Rail
827CW	B159	AN Counterweight Pkg
837CW	B159	AN Counterweight Pkg
847CW	B159	AN Counterweight Pkg
858CW	B159	AN Counterweight Pkg
877102002SR	B187, C263	Master Lock Tool
877102003SR	B187, C263	Standard Lock Tool
88PS	C146, C235, D94	Power Strips
88PSLC	C146, C235, D94	Power Strips
98765	C143, C234, D97	Termination Plate
98766	C143, C234, D97	Cable and Fiber Reels
98767	C143, C235, D98	Cord Reels
98768	C146, C235, D98	Cable Storage Tray
98863	B87	AN Duplex Cbl Grommet
99465	B157	AN Pencil Tray
999CHT	C144, D99	Wire Clips
ADJHTGASCYL	C140, D71	Pair of Gas Cylinders
BBC224242_	D54	Univ FS Rad Cor Str-Front Wksf
BBC224848_	D54	Univ FS Rad Cor Str-Front Wksf
BBC334848_	D54	Univ FS Rad Cor Str-Front Wksf
BBCKSC42P	D70	Univ FS Adjustable-Hgt Wksf
BBCKSC48P	D70	Univ FS Adjustable-Hgt Wksf
BBECSC42P	D73	Univ FS Adjustable-Hgt Wksf
BBECSC48P	D73	Univ FS Adjustable-Hgt Wksf
BCC224242_	D53	Univ FS Cor Crvd-Front Wksf
BCC224848_	D53	Univ FS Cor Crvd-Front Wksf
BCC334848_	D53	Univ FS Cor Crvd-Front Wksf
BCKBC42P	D70	Univ FS Adjustable-Hgt Wksf
BCKBC48P	D70	Univ FS Adjustable-Hgt Wksf
BCKBS42P	D71	Univ FS Adjustable-Hgt Wksf
BCKBS48P	D71	Univ FS Adjustable-Hgt Wksf
BCKDC42P	D70	Univ FS Adjustable-Hgt Wksf
BCKDC48P	D70	Univ FS Adjustable-Hgt Wksf
BCKDS42P	D71	Univ FS Adjustable-Hgt Wksf
BCKDS48P	D71	Univ FS Adjustable-Hgt Wksf
BCKSC42P	D70	Univ FS Adjustable-Hgt Wksf
BCKSC48P	D70	Univ FS Adjustable-Hgt Wksf
BCKSS42P	D71	Univ FS Adjustable-Hgt Wksf
BCKSS48P	D71	Univ FS Adjustable-Hgt Wksf
BE224260R_	D57	Univ FS Ext Cor Str-Front Wksf
BE224266R_	D57	Univ FS Ext Cor Str-Front Wksf
BE224272R_	D57	Univ FS Ext Cor Str-Front Wksf
BE224278R_	D57	Univ FS Ext Cor Str-Front Wksf

Style Number	Page	Description
BE224860R_	D57	Univ FS Ext Cor Str-Front Wksf
BE224866R_	D57	Univ FS Ext Cor Str-Front Wksf
BE224872R_	D57	Univ FS Ext Cor Str-Front Wksf
BE224878R_	D57	Univ FS Ext Cor Str-Front Wksf
BE226042L_	D57	Univ FS Ext Cor Str-Front Wksf
BE226048L_	D57	Univ FS Ext Cor Str-Front Wksf
BE226642L_	D57	Univ FS Ext Cor Str-Front Wksf
BE226648L_	D57	Univ FS Ext Cor Str-Front Wksf
BE227242L_	D57	Univ FS Ext Cor Str-Front Wksf
BE227248L_	D57	Univ FS Ext Cor Str-Front Wksf
BE227842L_	D57	Univ FS Ext Cor Str-Front Wksf
BE227848L_	D57	Univ FS Ext Cor Str-Front Wksf
BE234860R_	D57	Univ FS Ext Cor Str-Front Wksf
BE234866R_	D57	Univ FS Ext Cor Str-Front Wksf
BE234872R_	D57	Univ FS Ext Cor Str-Front Wksf
BE234878R_	D57	Univ FS Ext Cor Str-Front Wksf
BE326048L_	D57	Univ FS Ext Cor Str-Front Wksf
BE326648L_	D57	Univ FS Ext Cor Str-Front Wksf
BE327248L_	D57	Univ FS Ext Cor Str-Front Wksf
BE327848L_	D57	Univ FS Ext Cor Str-Front Wksf
BE334860R_	D57	Univ FS Ext Cor Str-Front Wksf
BE334866R_	D57	Univ FS Ext Cor Str-Front Wksf
BE334872R_	D57	Univ FS Ext Cor Str-Front Wksf
BE334878R_	D57	Univ FS Ext Cor Str-Front Wksf
BE336048L_	D57	Univ FS Ext Cor Str-Front Wksf
BE336648L_	D57	Univ FS Ext Cor Str-Front Wksf
BE337248L_	D57	Univ FS Ext Cor Str-Front Wksf
BE337848L_	D57	Univ FS Ext Cor Str-Front Wksf
BECDC42P	D73	Univ FS Adjustable-Hgt Wksf
BECDC48P	D73	Univ FS Adjustable-Hgt Wksf
BECD42P	D73	Univ FS Adjustable-Hgt Wksf
BECD48P	D73	Univ FS Adjustable-Hgt Wksf
BECS42P	D73	Univ FS Adjustable-Hgt Wksf
BECS48P	D73	Univ FS Adjustable-Hgt Wksf
BECS42P	D73	Univ FS Adjustable-Hgt Wksf
BECS48P	D73	Univ FS Adjustable-Hgt Wksf
BEL25	D75	Univ FS Elliptical Leg
BEL27	D75	Univ FS Elliptical Leg
BFB223636_	D58	Univ FS Corner 120° Wksf
BFB224242_	D58	Univ FS Corner 120° Wksf
BFB224848_	D58	Univ FS Corner 120° Wksf
BFB334242_	D58	Univ FS Corner 120° Wksf
BFB334848_	D58	Univ FS Corner 120° Wksf
BFC224242_	D52	Univ FS Cor Str-Front Wksf
BFC224848_	D52	Univ FS Cor Str-Front Wksf
BFC234848_	D52	Univ FS Cor Str-Front Wksf
BFC324848_	D52	Univ FS Cor Str-Front Wksf
BFC334848_	D52	Univ FS Cor Str-Front Wksf
BFFF661_	D69	Univ FS Tethered Capsule Wksf
BFFF721_	D69	Univ FS Tethered Capsule Wksf
BFFF841_	D69	Univ FS Tethered Capsule Wksf
BFFF961_	D69	Univ FS Tethered Capsule Wksf
BFFF962_	D69	Univ FS Tethered Capsule Wksf
BFJ2472L_	D63	Univ FS Bubble Jetty Wksf
BFJ2472R_	D63	Univ FS Bubble Jetty Wksf

Style Number	Page	Description
BFJ2478L_	D63	Univ FS Bubble Jetty Wksf
BFJ2478R_	D63	Univ FS Bubble Jetty Wksf
BFJ3072L_	D63	Univ FS Bubble Jetty Wksf
BFJ3072R_	D63	Univ FS Bubble Jetty Wksf
BFJ3078L_	D63	Univ FS Bubble Jetty Wksf
BFJ3078R_	D63	Univ FS Bubble Jetty Wksf
BFK2448_	D59	Univ FS Capsule Wksf
BFK3060_	D59	Univ FS Capsule Wksf
BFK3672_	D59	Univ FS Capsule Wksf
BFK4284_	D59	Univ FS Capsule Wksf
BFK4896_	D59	Univ FS Capsule Wksf
BFP2736_	D61	Univ FS Peninsula Wksf
BFR36_	D64	Univ FS Round Wksf
BFR42_	D64	Univ FS Round Wksf
BFR48_	D64	Univ FS Round Wksf
BFR54_	D64	Univ FS Round Wksf
BFRQ24_	D65	Univ FS Square Wksf
BFRQ30_	D65	Univ FS Square Wksf
BFRQ36_	D65	Univ FS Square Wksf
BFRQ42_	D65	Univ FS Square Wksf
BFRQ48_	D65	Univ FS Square Wksf
BFRQ54_	D65	Univ FS Square Wksf
BFRR3672_	D66	Univ FS Rectangle Wksf
BFRR4284_	D66	Univ FS Rectangle Wksf
BFRR4896_	D66	Univ FS Rectangle Wksf
BFS2430_	D49	Univ FS Straight Wksf
BFS2436_	D49	Univ FS Straight Wksf
BFS2442_	D49	Univ FS Straight Wksf
BFS2448_	D49	Univ FS Straight Wksf
BFS2454_	D49	Univ FS Straight Wksf
BFS2460_	D49	Univ FS Straight Wksf
BFS2466_	D49	Univ FS Straight Wksf
BFS2472_	D49	Univ FS Straight Wksf
BFS2478_	D49	Univ FS Straight Wksf
BFS3036_	D49	Univ FS Straight Wksf
BFS3042_	D49	Univ FS Straight Wksf
BFS3048_	D49	Univ FS Straight Wksf
BFS3054_	D49	Univ FS Straight Wksf
BFS3060_	D49	Univ FS Straight Wksf
BFS3066_	D49	Univ FS Straight Wksf
BFS3072_	D49	Univ FS Straight Wksf
BFS3078_	D49	Univ FS Straight Wksf
BFSP48_	D60	Univ FS Spanner Wksf
BFSP52_	D60	Univ FS Spanner Wksf
BFSP60_	D60	Univ FS Spanner Wksf
BFSP64_	D60	Univ FS Spanner Wksf
BFSPF52_	D67	Univ FS Hub Spanner Wksf
BFSPF64_	D67	Univ FS Hub Spanner Wksf
BFSPN52_	D68	Univ FS Split-Round Wksf
BFSPN64_	D68	Univ FS Split-Round Wksf
BFTP48_	D62	Univ FS Tapered Peninsula Wksf
BFTP60_	D62	Univ FS Tapered Peninsula Wksf
BPR	B158	AN Rail
BRC224242_	D55	Univ FS Rad Cor Crvd-Front Wksf
BRC224848_	D55	Univ FS Rad Cor Crvd-Front Wksf

Style Number	Page	Description
BRC334848_	D55	Univ FS Rad Cor Crvd-Front Wksf
BTB	D76	Univ FS Tether Bracket
BZC243060_	D51	Univ FS Transition Wksf
BZC243066_	D51	Univ FS Transition Wksf
BZC243072_	D51	Univ FS Transition Wksf
BZC243078_	D51	Univ FS Transition Wksf
BZC302460_	D51	Univ FS Transition Wksf
BZC302466_	D51	Univ FS Transition Wksf
BZC302472_	D51	Univ FS Transition Wksf
BZC302478_	D51	Univ FS Transition Wksf
BZC303660_	D51	Univ FS Transition Wksf
BZC303666_	D51	Univ FS Transition Wksf
BZC303672_	D51	Univ FS Transition Wksf
BZC303678_	D51	Univ FS Transition Wksf
BZC363060_	D51	Univ FS Transition Wksf
BZC363066_	D51	Univ FS Transition Wksf
BZC363072_	D51	Univ FS Transition Wksf
BZC363078_	D51	Univ FS Transition Wksf
CAP1520	B154	AN Mobile Pedestal Cap
CBUTTRESSL	B74	AN Buttress
CBUTTRESSR	B74	AN Buttress
CFENCELC	B75	AN Fence Connector
CFENCERC	B75	AN Fence Connector
DALK24	D79	Knit Screen
DALK30	D79	Knit Screen
DALK36	D79	Knit Screen
DALK42	D79	Knit Screen
DALP24	D79	Laminae Screen
DALP30	D79	Laminae Screen
DALP36	D79	Laminae Screen
DALP42	D79	Laminae Screen
DAP36	D79	Laminae Screen
DAP42	D79	Laminae Screen
DAP48	D79	Laminae Screen
DAP54	D79	Laminae Screen
DAVC	D96	Vertebral Cable Riser
DAVCE	D96	Vertebral Cable Riser Extension
DLNAC	D76	Univ FS Double Post C-Leg
DLNANP4	D76	Univ FS Single Post Leg Pkg
DLNANP4C	D76	Univ FS Single Post Leg w/Caster Pkg
DLNANPS	D76	Univ FS Single Post Leg
DLNANPSC	D76	Univ FS Single Post Leg w/Caster
DLNAP4	D76	Univ FS Single Post Leg Pkg
DLNAP4C	D76	Univ FS Single Post Leg w/Caster Pkg
DLNAPS	D76	Univ FS Single Post Leg
DLNAPSC	D76	Univ FS Single Post Leg w/Caster
DLNCAB264	D74	Univ FS Cabby Leg
DLNCAB26S	D74	Univ FS Cabby Leg
DLNCAB284	D74	Univ FS Cabby Leg
DLNCAB28S	D74	Univ FS Cabby Leg
DSCLAMP	D79	Pair of Attachment Clamps for Wksf
GFUBFM6X	C101, D84	Power Outfeed
GFUBFM6Y	C101, D84	Power Outfeed
GFUBFM6Z	C101, D84	Power Outfeed
GFUCCM	C97, D92	Cord and Cable Mgr

Style Number Index, continued

Style Number	Page	Description
GFUCH	C99, D90	Conven Outlet Housing
GFUCMC	C97, D92	Harness Clips
GFUFFH12X	C104, D82	Floor Power Infeed
GFUFFH12Y	C104, D82	Floor Power Infeed
GFUFFH12Z	C104, D82	Floor Power Infeed
GFUFFH6X	C104, D82	Floor Power Infeed
GFUFFH6Y	C104, D82	Floor Power Infeed
GFUFFH6Z	C104, D82	Floor Power Infeed
GFUMB	C96, D92	Mounting Bracket
GFUPMBX	C95, D85	Power Module
GFUPMBXNYC	C95, D85	Power Module
GFUPMBY	C95, D85	Power Module
GFUPMBYNYC	C95, D85	Power Module
GFUPMBZ	C95, D85	Power Module
GFUPMBZNYC	C95, D85	Power Module
GFUPMX	C95, D85	Power Module
GFUPMXNYC	C95, D85	Power Module
GFUPMY	C95, D85	Power Module
GFUPMYNYC	C95, D85	Power Module
GFUPMZ	C95, D85	Power Module
GFUPMZNYC	C95, D85	Power Module
GFUSCM	C96, D90	Communication Module
GFUT1G72X	C98, D89	Conven Tri-Receptacle
GFUT1G72Y	C98, D89	Conven Tri-Receptacle
GFUT1G72Z	C98, D89	Conven Tri-Receptacle
GFUT1S72X	C98, D89	Conven Tri-Receptacle
GFUT1S72Y	C98, D89	Conven Tri-Receptacle
GFUT1S72Z	C98, D89	Conven Tri-Receptacle
GFUT2G72X	C98, D89	Conven Tri-Receptacle
GFUT2G72Y	C98, D89	Conven Tri-Receptacle
GFUT2G72Z	C98, D89	Conven Tri-Receptacle
GFUT2S72X	C98, D89	Conven Tri-Receptacle
GFUT2S72Y	C98, D89	Conven Tri-Receptacle
GFUT2S72Z	C98, D89	Conven Tri-Receptacle
GFUT3G72X	C98, D89	Conven Tri-Receptacle
GFUT3G72Y	C98, D89	Conven Tri-Receptacle
GFUT3G72Z	C98, D89	Conven Tri-Receptacle
GFUT3S72X	C98, D89	Conven Tri-Receptacle
GFUT3S72Y	C98, D89	Conven Tri-Receptacle
GFUT3S72Z	C98, D89	Conven Tri-Receptacle
GFUT4G72X	C98, D89	Conven Tri-Receptacle
GFUT4G72Y	C98, D89	Conven Tri-Receptacle
GFUT4S72X	C98, D89	Conven Tri-Receptacle
GFUT4S72Y	C98, D89	Conven Tri-Receptacle
GFUTMB	C100, D91	Below-Wksf Mtg Brkt
GFUTMC	C100, D91	Above-Wksf Clamp Kit
GFUTP96	C99, D90	Conven Tri-Receptacle
GSCLCW	B159	AN Counterweight Pkg
GSGUBCX	D85	Internode Connector
GSGUBCY	D85	Internode Connector
GSGUBCZ	D85	Internode Connector
GSGUFC	D83	Internode Modular Infeed Cover

Style Number	Page	Description
GSGUFMH12X	C105, D83	Multipurp Pwr Infeed
GSGUFMH12Y	C105, D83	Multipurp Pwr Infeed
GSGUFMH12Z	C105, D83	Multipurp Pwr Infeed
GSGUFMH24X	C105, D83	Multipurp Pwr Infeed
GSGUFMH24Y	C105, D83	Multipurp Pwr Infeed
GSGUFMH24Z	C105, D83	Multipurp Pwr Infeed
GSGUFMM12X	C105, D83	Multipurp Pwr Infeed
GSGUFMM12Y	C105, D83	Multipurp Pwr Infeed
GSGUFMM12Z	C105, D83	Multipurp Pwr Infeed
GSGUFMM24X	C105, D83	Multipurp Pwr Infeed
GSGUFMM24Y	C105, D83	Multipurp Pwr Infeed
GSGUFMM24Z	C105, D83	Multipurp Pwr Infeed
GSGUH100X	C102, D86	Modular Harness
GSGUH100Y	C103, D87	Modular Harness
GSGUH100Z	C103, D87	Modular Harness
GSGUH11X	C102	MT Modular Harness
GSGUH11Y	C102	MT Modular Harness
GSGUH11Z	C103	MT Modular Harness
GSGUH120X	C102, D86	Modular Harness
GSGUH120Y	C103, D87	Modular Harness
GSGUH120Z	C103, D87	Modular Harness
GSGUH12X	C102, D86	Modular Harness
GSGUH12Y	C102, D86	Modular Harness
GSGUH12Z	C103, D87	Modular Harness
GSGUH144X	C102, D86	Modular Harness
GSGUH144Y	C103, D87	Modular Harness
GSGUH144Z	C103, D87	Modular Harness
GSGUH22X	C102, D86	Modular Harness
GSGUH22Y	C102, D86	Modular Harness
GSGUH22Z	C103, D87	Modular Harness
GSGUH28X	C102, D86	Modular Harness
GSGUH28Y	C102, D86	Modular Harness
GSGUH28Z	C103, D87	Modular Harness
GSGUH32X	C102, D86	Modular Harness
GSGUH32Y	C102, D86	Modular Harness
GSGUH32Z	C103, D87	Modular Harness
GSGUH38X	C102, D86	Modular Harness
GSGUH38Y	C102, D86	Modular Harness
GSGUH38Z	C103, D87	Modular Harness
GSGUH44X	C102, D86	Modular Harness
GSGUH44Y	C102, D86	Modular Harness
GSGUH44Z	C103, D87	Modular Harness
GSGUH50X	C102, D86	Modular Harness
GSGUH50Y	C103, D87	Modular Harness
GSGUH50Z	C103, D87	Modular Harness

Style Number	Page	Description	Style Number	Page	Description
GSGUH54X	C102, D86	Modular Harness	GSGUR3TSY	C107, D88	Internode Receptacle
GSGUH54Y	C103, D87	Modular Harness	GSGUR3TSZ	C107, D88	Internode Receptacle
GSGUH54Z	C103, D87	Modular Harness	GSGUR4SGX	C106, D88	Internode Receptacle
GSGUH64X	C102, D86	Modular Harness	GSGUR4SGY	C106, D88	Internode Receptacle
GSGUH64Y	C103, D87	Modular Harness	GSGUR4SSX	C106, D88	Internode Receptacle
GSGUH64Z	C103, D87	Modular Harness	GSGUR4SSY	C106, D88	Internode Receptacle
GSGUH76X	C102, D86	Modular Harness	GSGUR4TGX	C107, D88	Internode Receptacle
GSGUH76Y	C103, D87	Modular Harness	GSGUR4TGY	C107, D88	Internode Receptacle
GSGUH76Z	C103, D87	Modular Harness	GSGUR4TSX	C107, D88	Internode Receptacle
GSGUH88X	C102, D86	Modular Harness	GSGUR4TSY	C107, D88	Internode Receptacle
GSGUH88Y	C103, D87	Modular Harness	GVDDBOX	D95	Power/Data Box
GSGUH88Z	C103, D87	Modular Harness	GVPDBOX	D95	Power/Data Box
GSGUHCX	D86	Internode Connector	GVPPBOX	D95	Power/Power Box
GSGUHCY	D87	Internode Connector	JBIN24LMON	C149	MT Univ Overhead Bin
GSGUHCZ	D87	Internode Connector	JBIN24LTAK	B131	AN Univ Overhead Bin
GSGUHHX	D86	Internode Modular Harness	JBIN24LWMON	C150	MT Univ Overhead Bin
GSGUHHY	D87	Internode Modular Harness	JBIN24LWTAK	B132	AN Univ Overhead Bin
GSGUHHZ	D87	Internode Modular Harness	JBIN24MON	C148	MT Univ Overhead Bin
GSGUHSX	D86	Internode Modular Harness	JBIN24TAK	B130	AN Univ Overhead Bin
GSGUHSY	D87	Internode Modular Harness	JBIN30LMON	C149	MT Univ Overhead Bin
GSGUHSZ	D87	Internode Modular Harness	JBIN30LTAK	B131	AN Univ Overhead Bin
GSGUR1SGX	C106, D88	Internode Receptacle	JBIN30LWMON	C150	MT Univ Overhead Bin
GSGUR1SGY	C106, D88	Internode Receptacle	JBIN30LWTAK	B132	AN Univ Overhead Bin
GSGUR1SGZ	C106, D88	Internode Receptacle	JBIN30MON	C148	MT Univ Overhead Bin
GSGUR1SSX	C106, D88	Internode Receptacle	JBIN30TAK	B130	AN Univ Overhead Bin
GSGUR1SSY	C106, D88	Internode Receptacle	JBIN36LMON	C149	MT Univ Overhead Bin
GSGUR1SSZ	C106, D88	Internode Receptacle	JBIN36LTAK	B131	AN Univ Overhead Bin
GSGUR1TGX	C107, D88	Internode Receptacle	JBIN36LWMON	C150	MT Univ Overhead Bin
GSGUR1TGY	C107, D88	Internode Receptacle	JBIN36LWTAK	B132	AN Univ Overhead Bin
GSGUR1TGZ	C107, D88	Internode Receptacle	JBIN36MON	C148	MT Univ Overhead Bin
GSGUR1TSX	C107, D88	Internode Receptacle	JBIN36TAK	B130	AN Univ Overhead Bin
GSGUR1TSY	C107, D88	Internode Receptacle	JBIN42LMON	C149	MT Univ Overhead Bin
GSGUR1TSZ	C107, D88	Internode Receptacle	JBIN42LTAK	B131	AN Univ Overhead Bin
GSGUR2SGX	C106, D88	Internode Receptacle	JBIN42LWMON	C150	MT Univ Overhead Bin
GSGUR2SGY	C106, D88	Internode Receptacle	JBIN42LWTAK	B132	AN Univ Overhead Bin
GSGUR2SGZ	C106, D88	Internode Receptacle	JBIN42MON	C148	MT Univ Overhead Bin
GSGUR2SSX	C106, D88	Internode Receptacle	JBIN42TAK	B130	AN Univ Overhead Bin
GSGUR2SSY	C106, D88	Internode Receptacle	JBIN48LMON	C149	MT Univ Overhead Bin
GSGUR2SSZ	C106, D88	Internode Receptacle	JBIN48LTAK	B131	AN Univ Overhead Bin
GSGUR2TGX	C107, D88	Internode Receptacle	JBIN48LWMON	C150	MT Univ Overhead Bin
GSGUR2TGY	C107, D88	Internode Receptacle	JBIN48LWTAK	B132	AN Univ Overhead Bin
GSGUR2TGZ	C107, D88	Internode Receptacle	JBIN48MON	C148	MT Univ Overhead Bin
GSGUR2TSX	C107, D88	Internode Receptacle	JBIN48TAK	B130	AN Univ Overhead Bin
GSGUR2TSY	C107, D88	Internode Receptacle	JBIN60LMON	C149	MT Univ Overhead Bin
GSGUR2TSZ	C107, D88	Internode Receptacle	JBIN60LTAK	B131	AN Univ Overhead Bin
GSGUR3SGX	C106, D88	Internode Receptacle	JBIN60LWMON	C150	MT Univ Overhead Bin
GSGUR3SGY	C106, D88	Internode Receptacle	JBIN60LWTAK	B132	AN Univ Overhead Bin
GSGUR3SGZ	C106, D88	Internode Receptacle	JBIN60MON	C148	MT Univ Overhead Bin
GSGUR3SSX	C106, D88	Internode Receptacle	JBIN60TAK	B130	AN Univ Overhead Bin
GSGUR3SSY	C106, D88	Internode Receptacle	JBIN72LMON	C149	MT Univ Overhead Bin
GSGUR3SSZ	C106, D88	Internode Receptacle	JBIN72LTAK	B131	AN Univ Overhead Bin
GSGUR3TGX	C107, D88	Internode Receptacle	JBIN72LWMON	C150	MT Univ Overhead Bin
GSGUR3TGY	C107, D88	Internode Receptacle	JBIN72LWTAK	B132	AN Univ Overhead Bin
GSGUR3TGZ	C107, D88	Internode Receptacle	JBIN72MON	C148	MT Univ Overhead Bin
GSGUR3TSX	C107, D88	Internode Receptacle	JBIN72TAK	B130	AN Univ Overhead Bin

Style Number Index, continued

Style Number	Page	Description
JSHF24MON	C151	MT Univ Full-Hgt Shelf
JSHF24TAK	B133	AN Univ Full-Hgt Shelf
JSHF30MON	C151	MT Univ Full-Hgt Shelf
JSHF30TAK	B133	AN Univ Full-Hgt Shelf
JSHF36MON	C151	MT Univ Full-Hgt Shelf
JSHF36TAK	B133	AN Univ Full-Hgt Shelf
JSHF42MON	C151	MT Univ Full-Hgt Shelf
JSHF42TAK	B133	AN Univ Full-Hgt Shelf
JSHF48MON	C151	MT Univ Full-Hgt Shelf
JSHF48TAK	B133	AN Univ Full-Hgt Shelf
JSHF60MON	C151	MT Univ Full-Hgt Shelf
JSHF60TAK	B133	AN Univ Full-Hgt Shelf
JSHF72MON	C151	MT Univ Full-Hgt Shelf
JSHF72TAK	B133	AN Univ Full-Hgt Shelf
KBIN30L_	B139, C157	Univ Curved-Front Bin
KBIN30LW_	B140, C158	Univ Curved-Front Bin w/Wood Door
KBIN36L_	B139, C157	Univ Curved-Front Bin
KBIN36LW_	B140, C158	Univ Curved-Front Bin w/Wood Door
KBIN42L_	B139, C157	Univ Curved-Front Bin
KBIN42LW_	B140, C158	Univ Curved-Front Bin w/Wood Door
KBIN45L_	B139, C157	Univ Curved-Front Bin
KBIN45LW_	B140, C158	Univ Curved-Front Bin w/Wood Door
KBIN48L_	B139, C157	Univ Curved-Front Bin
KBIN48LW_	B140, C158	Univ Curved-Front Bin w/Wood Door
KDISPLAY24	B142, C161	Univ Display Shelf
KDIV02	B144, C162	Bookends
KDIV20	B144, C162	Bookends
KGANG	B144, C162	Ganging Bracket
KGANG20	B144, C162	Ganging Bracket
KLSHF30_	B141, C159	Univ L-Shelf
KLSHF36_	B141, C159	Univ L-Shelf
KLSHF42_	B141, C159	Univ L-Shelf
KLSHF45_	B141, C159	Univ L-Shelf
KLSHF48_	B141, C159	Univ L-Shelf
KPULL	B144, C162	ADA Pull
KSSHF30	B142, C161	Univ Stationary Shelf
KSSHF36	B142, C161	Univ Stationary Shelf
KSSHF42	B142, C161	Univ Stationary Shelf
KSSHF45	B142, C161	Univ Stationary Shelf
KSSHF48	B142, C161	Univ Stationary Shelf
LCP24K	B169, C241	Canopy Light
LCP24KC	B169, C241	Canopy Light
LCP24KR	B169, C241	Canopy Light
LCP24KRC	B169, C241	Canopy Light
LCP36K	B169, C241	Canopy Light
LCP36KC	B169, C241	Canopy Light
LCP36KR	B169, C241	Canopy Light
LCP36KRC	B169, C241	Canopy Light
LCP48K	B169, C241	Canopy Light
LCP48KC	B169, C241	Canopy Light
LCP48KR	B169, C241	Canopy Light
LCP48KRC	B169, C241	Canopy Light
LCS24K	B166, C238	Canopy Light
LCS24KC	B166, C238	Canopy Light

Style Number	Page	Description
LCS24KR	B166, C238	Canopy Light
LCS24KRC	B166, C238	Canopy Light
LCS36K	B166, C238	Canopy Light
LCS36KC	B166, C238	Canopy Light
LCS36KR	B166, C238	Canopy Light
LCS36KRC	B166, C238	Canopy Light
LCS48K	B166, C238	Canopy Light
LCS48KC	B166, C238	Canopy Light
LCS48KR	B166, C238	Canopy Light
LCS48KRC	B166, C238	Canopy Light
LCWRIS	B170, C242	Rail-Mounting Riser
LOCK9201FR	B187, C263	Lock Cylinder
LOCK9201XF	B187, C263	Lock Cylinder
LOCK9230XF	C263	Lock Cylinder
LOCK9250FR	B187, C263	Lock Cylinder
LOCK9250XF	B187, C263	Lock Cylinder
LS1FSC	B173, B175, B177, C245, C247, C249	Daisy Chain Cord
LS6FSC	B173, B175, B177, C245, C247, C249	Daisy Chain Cord
LSB18M	B177, C249	Utility Light
LSB18MC	B177, C249	Utility Light
LSB18MD	B177, C249	Utility Light
LSB24K	B176, C248	Utility Light
LSB24KC	B176, C248	Utility Light
LSB24KD	B176, C248	Utility Light
LSB24M	B177, C249	Utility Light
LSB24MC	B177, C249	Utility Light
LSB24MD	B177, C249	Utility Light
LSB36K	B176, C248	Utility Light
LSB36KC	B176, C248	Utility Light
LSB36KD	B176, C248	Utility Light
LSB36M	B177, C249	Utility Light
LSB36MC	B177, C249	Utility Light
LSB36MD	B177, C249	Utility Light
LSB48K	B176, C248	Utility Light
LSB48KC	B176, C248	Utility Light
LSB48KD	B176, C248	Utility Light
LSB48M	B177, C249	Utility Light
LSB48MC	B177, C249	Utility Light
LSB48MD	B177, C249	Utility Light
LSH24K	B173, C245	Advanced Light
LSH24KC	B173, C245	Advanced Light
LSH24KD	B173, C245	Advanced Light
LSH24KDR	B173, C245	Advanced Light
LSH24KF	B172, C244	Advanced Light
LSH24KFC	B172, C244	Advanced Light
LSH24KFD	B172, C244	Advanced Light
LSH24KR	B173, C245	Advanced Light
LSH24KRC	B173, C245	Advanced Light

Style Number	Page	Description	Style Number	Page	Description
LSH36K	B173, C245	Advanced Light	TS5GANGBKT	C145, D100	Ganging Bracket for Tables
LSH36KC	B173, C245	Advanced Light	TS5LEGCLP	C144, D99	Velcro Wire Clips
LSH36KD	B173, C245	Advanced Light	TS5SKEXT	D97	Skeleton Bone Wire Mgr Extension
LSH36KDR	B173, C245	Advanced Light	TS5SKLBNE	D97	Skeleton Bone Wire Manager
LSH36KF	B172, C244	Advanced Light	TS7024BL	B147	AN Overhead Bin
LSH36KFC	B172, C244	Advanced Light	TS7024S	B148	AN Full-Hgt Shelf
LSH36KFD	B172, C244	Advanced Light	TS7024SH	B148	AN Half-Hgt Shelf
LSH36KR	B173, C245	Advanced Light	TS7030BL	B147	AN Overhead Bin
LSH36KRC	B173, C245	Advanced Light	TS7030S	B148	AN Full-Hgt Shelf
LSH48K	B173, C245	Advanced Light	TS7030SH	B148	AN Half-Hgt Shelf
LSH48KC	B173, C245	Advanced Light	TS7036BL	B147	AN Overhead Bin
LSH48KD	B173, C245	Advanced Light	TS7036S	B148	AN Full-Hgt Shelf
LSH48KDR	B173, C245	Advanced Light	TS7036SH	B148	AN Half-Hgt Shelf
LSH48KF	B172, C244	Advanced Light	TS7042BL	B147	AN Overhead Bin
LSH48KFC	B172, C244	Advanced Light	TS7042S	B148	AN Full-Hgt Shelf
LSH48KFD	B172, C244	Advanced Light	TS7042SH	B148	AN Half-Hgt Shelf
LSH48KR	B173, C245	Advanced Light	TS7048BL	B147	AN Overhead Bin
LSH48KRC	B173, C245	Advanced Light	TS7048S	B148	AN Full-Hgt Shelf
LSM24K	B174, C246	Standard Light	TS7048SH	B148	AN Half-Hgt Shelf
LSM24KC	B174, C246	Standard Light	TS7060BL	B147	AN Overhead Bin
LSM24KD	B174, C246	Standard Light	TS7060S	B148	AN Full-Hgt Shelf
LSM24KF	B175, C247	Standard Light	TS7060SH	B148	AN Half-Hgt Shelf
LSM24KFC	B175, C247	Standard Light	TS7072BL	B147	AN Overhead Bin
LSM24KFD	B175, C247	Standard Light	TS7072S	B148	AN Full-Hgt Shelf
LSM36K	B174, C246	Standard Light	TS7072SH	B148	AN Half-Hgt Shelf
LSM36KC	B174, C246	Standard Light	TS70WPC	B125	AN Side Support Bracket
LSM36KD	B174, C246	Standard Light	TS71218HS	B54	AN Steel Panel Skin
LSM36KF	B175, C247	Standard Light	TS71218TA	B51	AN Perf Tack Fab-Cvr Pnl Skin
LSM36KFC	B175, C247	Standard Light	TS71218TK	B53	AN Tack Fab-Cvr Pnl Skin
LSM36KFD	B175, C247	Standard Light	TS71224DPW	B60	AN Glass Window
LSM48K	B174, C246	Standard Light	TS71224HS	B54	AN Steel Panel Skin
LSM48KC	B174, C246	Standard Light	TS71224MBS	B56	AN Marker Brd Surface
LSM48KD	B174, C246	Standard Light	TS71224SCW	B61	AN Sgl-Pane Window Kit
LSM48KF	B175, C247	Standard Light	TS71224SPW	B60	AN Glass Window
LSM48KFC	B175, C247	Standard Light	TS71224SW	B57	AN Slatwall Skin
LSM48KFD	B175, C247	Standard Light	TS71224TA	B51	AN Perf Tack Fab-Cvr Pnl Skin
PAB12	B157	AN Ped Attachment Cable	TS71224TK	B53	AN Tack Fab-Cvr Pnl Skin
PAB12M	B157	AN Ped Attachment Cable	TS71224TS	B63	AN Technology Skin
PTDMGB1	C232, D93	Power Sphere	TS71224WG	B58	AN Glass Window
PTDMGB2	C232, D93	Power Sphere	TS71224WP	B59	AN Pass-Thru Window
PTDMGB3	C232, D93	Power and Communication Sphere	TS71230DPW	B60	AN Glass Window
PTDMGB4	C232, D93	Power and Communication Sphere	TS71230HS	B54	AN Steel Panel Skin
PTDMGB5	C233, D94	Communication Sphere	TS71230MBS	B56	AN Marker Brd Surface
PTGRMT	D95	Round Grommet	TS71230PTS	B62	AN Panel Top Screen
PTRSGB1	C233, D94	Round Power and Communication Port	TS71230SCW	B61	AN Sgl-Pane Window Kit
PTWM25	C145, D100	Wire Manager	TS71230SPW	B60	AN Glass Window
RPXFTAKPP	B151	AN Pedestal Filler	TS71230SW	B57	AN Slatwall Skin
RPXTC24P	B153	AN Cushion Top	TS71230TA	B51	AN Perf Tack Fab-Cvr Pnl Skin
RPXTCH24P	B153	AN Cushion Top	TS71230TK	B53	AN Tack Fab-Cvr Pnl Skin
TS200DV12	B158	AN Dividers	TS71230TS	B63	AN Technology Skin
TS2PBDD	B158	AN Dividers	TS71230WG	B58	AN Glass Window
TS2PFDD	B158	AN Dividers	TS71230WP	B59	AN Pass-Thru Window
TS2PPT	B157	AN Pencil Tray	TS71236DPW	B60	AN Glass Window
TS40007	B162	AN Markerboard	TS71236HS	B54	AN Steel Panel Skin
TS40008	B163	AN Tackboard			

Style Number Index, continued

Style Number	Page	Description
TS71236MBS	B56	AN Marker Brd Surface
TS71236PTS	B62	AN Panel Top Screen
TS71236SCW	B61	AN Sgl-Pane Window Kit
TS71236SPW	B60	AN Glass Window
TS71236SW	B57	AN Slatwall Skin
TS71236TA	B51	AN Perf Tack Fab-Cvr Pnl Skin
TS71236TK	B53	AN Tack Fab-Cvr Pnl Skin
TS71236TS	B63	AN Technology Skin
TS71236WG	B58	AN Glass Window
TS71236WP	B59	AN Pass-Thru Window
TS71242DPW	B60	AN Glass Window
TS71242HS	B54	AN Steel Panel Skin
TS71242MBS	B56	AN Marker Brd Surface
TS71242PTS	B62	AN Panel Top Screen
TS71242SCW	B61	AN Sgl-Pane Window Kit
TS71242SPW	B60	AN Glass Window
TS71242SW	B57	AN Slatwall Skin
TS71242TA	B51	AN Perf Tack Fab-Cvr Pnl Skin
TS71242TK	B53	AN Tack Fab-Cvr Pnl Skin
TS71242TS	B63	AN Technology Skin
TS71242WG	B58	AN Glass Window
TS71242WP	B59	AN Pass-Thru Window
TS71248DPW	B60	AN Glass Window
TS71248HS	B54	AN Steel Panel Skin
TS71248MBS	B56	AN Marker Brd Surface
TS71248PTS	B62	AN Panel Top Screen
TS71248SCW	B61	AN Sgl-Pane Window Kit
TS71248SPW	B60	AN Glass Window
TS71248SW	B57	AN Slatwall Skin
TS71248TA	B51	AN Perf Tack Fab-Cvr Pnl Skin
TS71248TK	B53	AN Tack Fab-Cvr Pnl Skin
TS71248TS	B63	AN Technology Skin
TS71248WG	B58	AN Glass Window
TS71248WP	B59	AN Pass-Thru Window
TS71260DPW	B60	AN Glass Window
TS71260HS	B54	AN Steel Panel Skin
TS71260SCW	B61	AN Sgl-Pane Window Kit
TS71260SPW	B60	AN Glass Window
TS71260TA	B51	AN Perf Tack Fab-Cvr Pnl Skin
TS71260TK	B53	AN Tack Fab-Cvr Pnl Skin
TS71260TS	B63	AN Technology Skin
TS71260WG	B58	AN Glass Window
TS71260WP	B59	AN Pass-Thru Window
TS71272DPW	B60	AN Glass Window
TS71272HS	B54	AN Steel Panel Skin
TS71272SCW	B61	AN Sgl-Pane Window Kit
TS71272SPW	B60	AN Glass Window
TS71272TA	B51	AN Perf Tack Fab-Cvr Pnl Skin
TS71272TK	B53	AN Tack Fab-Cvr Pnl Skin
TS71272TS	B63	AN Technology Skin
TS71272WG	B58	AN Glass Window
TS71272WP	B59	AN Pass-Thru Window
TS712BPX	B82	AN Power Infeed
TS712BPY	B82	AN Power Infeed
TS712BPZ	B82	AN Power Infeed

Style Number	Page	Description
TS712CH	B42	AN Change-of-Hgt Trim
TS712CHS	B42	AN Change-of-Hgt Trim
TS712CHST	B44	AN Change-of-Hgt Trim
TS712CHSTW	B45	AN Change-of-Hgt Trim
TS712CHSW	B43	AN Change-of-Hgt Trim
TS712CHT	B44	AN Change-of-Hgt Trim
TS712CHTW	B45	AN Change-of-Hgt Trim
TS712CHW	B43	AN Change-of-Hgt Trim
TS712EPJS	B36	AN Panel Junction
TS712EPJSW	B37	AN Panel Junction
TS712IPJS	B33	AN Panel Junction
TS712LPJS	B34	AN Panel Junction
TS712LPJSW	B35	AN Panel Junction
TS712TPJS	B34	AN Panel Junction
TS712TPJSW	B35	AN Panel Junction
TS712UPHX	B84	AN Power Harness
TS712UPHY	B84	AN Power Harness
TS712UPHZ	B84	AN Power Harness
TS712VPJS	B38	AN Panel Junction
TS712VPJSW	B39	AN Panel Junction
TS712WPJS	B40	AN Junction
TS712XPJS	B34	AN Panel Junction
TS712YPJS	B38	AN Panel Junction
TS714WSP	B125, D39	Support Plate
TS71530MBB	B160	AN Markerboard Surf
TS71536MBB	B160	AN Markerboard Surf
TS71542MBB	B160	AN Markerboard Surf
TS71548MBB	B160	AN Markerboard Surf
TS71636TC	B116	AN Trans Countertop
TS71642TC	B116	AN Trans Countertop
TS71648TC	B116	AN Trans Countertop
TS71660TC	B116	AN Trans Countertop
TS718CT	B76	AN Cable Tray
TS718HF	B46	AN Horiz Frame Pkg
TS718HFS	B47	AN Horiz Frame Pkg
TS71SGX	B80	AN 15-Amp Receptacle
TS71SGY	B80	AN 15-Amp Receptacle
TS71SGZ	B81	AN 15-Amp Receptacle
TS71SSX	B80	AN 15-Amp Receptacle
TS71SSY	B80	AN 15-Amp Receptacle
TS71SSZ	B81	AN 15-Amp Receptacle
TS720WSP	B125, D39	Support Plate
TS72142WT	B113	AN Oval Wksf
TS7224260ER	B101	AN Ext Crv Corner Wksf
TS7224272ER	B101	AN Ext Crv Corner Wksf
TS7224860ER	B101	AN Ext Crv Corner Wksf
TS7224872ER	B101	AN Ext Crv Corner Wksf
TS7226042EL	B99	AN Ext Crv Corner Wksf
TS7226048EL	B99	AN Ext Crv Corner Wksf
TS7227242EL	B99	AN Ext Crv Corner Wksf
TS7227248EL	B99	AN Ext Crv Corner Wksf
TS7234260ER	B101	AN Ext Crv Corner Wksf
TS7234272ER	B101	AN Ext Crv Corner Wksf
TS7234860ER	B101	AN Ext Crv Corner Wksf
TS7234872ER	B101	AN Ext Crv Corner Wksf

Style Number	Page	Description	Style Number	Page	Description
TS7236042EL	B99	AN Ext Crv Corner Wksf	TS72442SCP	B97	AN Str Corner Wksf
TS7236048EL	B99	AN Ext Crv Corner Wksf	TS72442SCW	B61	AN Sgl-Pane Window Kit
TS7237242EL	B99	AN Ext Crv Corner Wksf	TS72442SPW	B60	AN Glass Window
TS7237248EL	B99	AN Ext Crv Corner Wksf	TS72442SW	B57	AN Slatwall Skin
TS72418HS	B54	AN Steel Panel Skin	TS72442TA	B51	AN Perf Tack Fab-Cvr Pnl Skin
TS72418TA	B51	AN Perf Tack Fab-Cvr Pnl Skin	TS72442TK	B53	AN Tack Fab-Cvr Pnl Skin
TS72418TK	B53	AN Tack Fab-Cvr Pnl Skin	TS72442WG	B58	AN Glass Window
TS72424DPW	B60	AN Glass Window	TS72442WP	B59	AN Pass-Thru Window
TS72424HS	B54	AN Steel Panel Skin	TS72448AP	B109	AN Angled Peninsula Wksf
TS72424MBS	B56	AN Marker Brd Surface	TS72448CC	B96	AN Crvd Corner Wksf
TS72424S	B93	AN Straight Wksf	TS72448CCP	B97	AN Crvd Corner Wksf
TS72424SCW	B61	AN Sgl-Pane Window Kit	TS72448DPW	B60	AN Glass Window
TS72424SPW	B60	AN Glass Window	TS72448HS	B54	AN Steel Panel Skin
TS72424SW	B57	AN Slatwall Skin	TS72448MBS	B56	AN Marker Brd Surface
TS72424TA	B51	AN Perf Tack Fab-Cvr Pnl Skin	TS72448S	B93	AN Straight Wksf
TS72424TK	B53	AN Tack Fab-Cvr Pnl Skin	TS72448SC	B95	AN Str Corner Wksf
TS72424V	B115	AN Visitor Window	TS72448SCP	B97	AN Str Corner Wksf
TS72424WG	B58	AN Glass Window	TS72448SCW	B61	AN Sgl-Pane Window Kit
TS72424WP	B59	AN Pass-Thru Window	TS72448SPW	B60	AN Glass Window
TS7243036T	B94	AN Transition Wksf	TS72448SW	B57	AN Slatwall Skin
TS7243042T	B94	AN Transition Wksf	TS72448TA	B51	AN Perf Tack Fab-Cvr Pnl Skin
TS7243048T	B94	AN Transition Wksf	TS72448TK	B53	AN Tack Fab-Cvr Pnl Skin
TS7243060T	B94	AN Transition Wksf	TS72448WG	B58	AN Glass Window
TS72430DPW	B60	AN Glass Window	TS72448WP	B59	AN Pass-Thru Window
TS72430HS	B54	AN Steel Panel Skin	TS72460AP	B109	AN Angled Peninsula Wksf
TS72430MBS	B56	AN Marker Brd Surface	TS72460DPW	B60	AN Glass Window
TS72430S	B93	AN Straight Wksf	TS72460HS	B54	AN Steel Panel Skin
TS72430SCW	B61	AN Sgl-Pane Window Kit	TS72460S	B93	AN Straight Wksf
TS72430SPW	B60	AN Glass Window	TS72460SCW	B61	AN Sgl-Pane Window Kit
TS72430SW	B57	AN Slatwall Skin	TS72460SPW	B60	AN Glass Window
TS72430TA	B51	AN Perf Tack Fab-Cvr Pnl Skin	TS72460TA	B51	AN Perf Tack Fab-Cvr Pnl Skin
TS72430TK	B53	AN Tack Fab-Cvr Pnl Skin	TS72460TK	B53	AN Tack Fab-Cvr Pnl Skin
TS72430V	B115	AN Visitor Wksf	TS72466S	B93	AN Straight Wksf
TS72430WG	B58	AN Glass Window	TS72472HS	B54	AN Steel Panel Skin
TS72430WP	B59	AN Pass-Thru Window	TS72472S	B93	AN Straight Wksf
TS72436CC	B96	AN Crvd Corner Wksf	TS72472TA	B51	AN Perf Tack Fab-Cvr Pnl Skin
TS72436DPW	B60	AN Glass Window	TS72472TK	B53	AN Tack Fab-Cvr Pnl Skin
TS72436HS	B54	AN Steel Panel Skin	TS724BKT	B32	AN Off-Module Conn
TS72436MBS	B56	AN Marker Brd Surface	TS724CH	B42	AN Change-of-Hgt Trim
TS72436S	B93	AN Straight Wksf	TS724CHS	B42	AN Change-of-Hgt Trim
TS72436SC	B95	AN Str Corner Wksf	TS724CHST	B44	AN Change-of-Hgt Trim
TS72436SCW	B61	AN Sgl-Pane Window Kit	TS724CHSTW	B45	AN Change-of-Hgt Trim
TS72436SPW	B60	AN Glass Window	TS724CHSW	B43	AN Change-of-Hgt Trim
TS72436SW	B57	AN Slatwall Skin	TS724CHT	B44	AN Change-of-Hgt Trim
TS72436TA	B51	AN Perf Tack Fab-Cvr Pnl Skin	TS724CHTW	B45	AN Change-of-Hgt Trim
TS72436TK	B53	AN Tack Fab-Cvr Pnl Skin	TS724CHW	B43	AN Change-of-Hgt Trim
TS72436WG	B58	AN Glass Window	TS724CT	B76	AN Cable Tray
TS72436WP	B59	AN Pass-Thru Window	TS724EPJS	B36	AN Panel Junction
TS72442CC	B96	AN Crvd Corner Wksf	TS724EPJSW	B37	AN Panel Junction
TS72442CCP	B97	AN Crvd Corner Wksf	TS724EPNL	B126	AN End Panel
TS72442DPW	B60	AN Glass Window	TS724EPS	B126	AN End Panel
TS72442HS	B54	AN Steel Panel Skin	TS724FLR	B156	AN Answer Filler
TS72442MBS	B56	AN Marker Brd Surface	TS724HF	B46	AN Horiz Frame Pkg
TS72442S	B93	AN Straight Wksf	TS724HFS	B47	AN Horiz Frame Pkg
TS72442SC	B95	AN Str Corner Wksf	TS724IPJS	B33	AN Panel Junction

Style Number Index, continued

Style Number	Page	Description
TS724LPJS	B34	AN Panel Junction
TS724LPJSW	B35	AN Panel Junction
TS724MP	B127	AN Modesty Panel
TS724TPJS	B34	AN Panel Junction
TS724TPJSW	B35	AN Panel Junction
TS724UPHX	B84	AN Power Harness
TS724UPHY	B84	AN Power Harness
TS724UPHZ	B84	AN Power Harness
TS724VPJS	B38	AN Panel Junction
TS724VPJSW	B39	AN Panel Junction
TS724WPJS	B40	AN Junction
TS724XPJS	B34	AN Panel Junction
TS724YPJS	B38	AN Panel Junction
TS72626LK	B122	AN Crvd Linking Wksf
TS72632LK	B122	AN Crvd Linking Wksf
TS72648APK	B120	AN Angled Peninsula Wksf
TS72660APK	B120	AN Angled Peninsula Wksf
TS72727L	B115	AN Crvd Linking Wksf
TS72733L	B115	AN Crvd Linking Wksf
TS72748AP	B109	AN Angled Peninsula Wksf
TS72760AP	B109	AN Angled Peninsula Wksf
TS725GX	B80	AN 15-Amp Receptacle
TS725GY	B80	AN 15-Amp Receptacle
TS725GZ	B81	AN 15-Amp Receptacle
TS725SX	B80	AN 15-Amp Receptacle
TS725SY	B80	AN 15-Amp Receptacle
TS725SZ	B81	AN 15-Amp Receptacle
TS7302436T	B94	AN Transition Wksf
TS7302442T	B94	AN Transition Wksf
TS7302448T	B94	AN Transition Wksf
TS7302460T	B94	AN Transition Wksf
TS73024S	B93	AN Straight Wksf
TS73024V	B115	AN Visitor Wksf
TS73030S	B93	AN Straight Wksf
TS73030V	B115	AN Visitor Wksf
TS73036S	B93	AN Straight Wksf
TS73042BR	B102	AN Bridge Wksf
TS73042CC	B96	AN Crvd Corner Wksf
TS73042S	B93	AN Straight Wksf
TS73042SC	B95	AN Str Corner Wksf
TS73048AP	B109	AN Angled Peninsula Wksf
TS73048BR	B102	AN Bridge Wksf
TS73048CC	B96	AN Crvd Corner Wksf
TS73048CCP	B97	AN Crvd Corner Wksf
TS73048P	B107	AN Peninsula Wksf
TS73048S	B93	AN Straight Wksf
TS73048SC	B95	AN Str Corner Wksf
TS73048SCP	B97	AN Str Corner Wksf
TS73060AP	B109	AN Angled Peninsula Wksf
TS73060BP	B107	AN Peninsula Wksf
TS73060P	B107	AN Peninsula Wksf
TS73060S	B93	AN Straight Wksf
TS73060WT	B113	AN Oval Wksf
TS73066BP	B107	AN Peninsula Wksf
TS73066S	B93	AN Straight Wksf

Style Number	Page	Description
TS73072BP	B107	AN Peninsula Wksf
TS73072S	B93	AN Straight Wksf
TS73096SP	B103	AN Scoop Wksf
TS730BKT	B32	AN Off-Module Conn
TS730CP	B87	AN Consol Pt Door Skin
TS730CT	B76	AN Cable Tray
TS730EPJ	B27	AN Junction
TS730EPJW	B28	AN Junction
TS730EPNL	B126	AN End Panel
TS730EPS	B126	AN End Panel
TS730FLR	B156	AN Answer Filler
TS730HF	B46	AN Horiz Frame Pkg
TS730HFS	B47	AN Horiz Frame Pkg
TS730IPJ	B24	AN Junction
TS730LPJ	B25	AN Junction
TS730LPJW	B26	AN Junction
TS730MP	B127	AN Modesty Panel
TS730SUC	B89	AN Ceil-Acc Lay-In Util Pkg
TS730SUF	B90	AN Flr-Acc Lay-In Util Pkg
TS730TPJ	B25	AN Junction
TS730TPJW	B26	AN Junction
TS730VPJ	B29	AN Junction
TS730VPJW	B30	AN Junction
TS730XPJ	B25	AN Junction
TS730XPJW	B26	AN Junction
TS730YPJ	B29	AN Junction
TS730YPJW	B30	AN Junction
TS73226LK	B122	AN Crvd Linking Wksf
TS73232LK	B122	AN Crvd Linking Wksf
TS7324260ER	B101	AN Ext Crv Corner Wksf
TS7324272ER	B101	AN Ext Crv Corner Wksf
TS7324860ER	B101	AN Ext Crv Corner Wksf
TS7324872ER	B101	AN Ext Crv Corner Wksf
TS73248APK	B120	AN Angled Peninsula Wksf
TS7326042EL	B99	AN Ext Crv Corner Wksf
TS7326048EL	B99	AN Ext Crv Corner Wksf
TS73260APK	B120	AN Angled Peninsula Wksf
TS7327242EL	B99	AN Ext Crv Corner Wksf
TS7327248EL	B99	AN Ext Crv Corner Wksf
TS73327L	B115	AN Crvd Linking Wksf
TS73333L	B115	AN Crvd Linking Wksf
TS7334260ER	B101	AN Ext Crv Corner Wksf
TS7334272ER	B101	AN Ext Crv Corner Wksf
TS7334860ER	B101	AN Ext Crv Corner Wksf
TS7334872ER	B101	AN Ext Crv Corner Wksf
TS73348AP	B109	AN Angled Peninsula Wksf
TS7336042EL	B99	AN Ext Crv Corner Wksf
TS7336048EL	B99	AN Ext Crv Corner Wksf
TS73360AP	B109	AN Angled Peninsula Wksf
TS7337242EL	B99	AN Ext Crv Corner Wksf
TS7337248EL	B99	AN Ext Crv Corner Wksf
TS73618HS	B55	AN Steel Panel Skin
TS73618TA	B51	AN Perf Tack Fab-Cvr Pnl Skin
TS73618TK	B53	AN Tack Fab-Cvr Pnl Skin
TS73624HS	B55	AN Steel Panel Skin

Style Number	Page	Description	Style Number	Page	Description
TS73624MBS	B56	AN Marker Brd Surface	TS73SSZ	B81	AN 15-Amp Receptacle
TS73624TA	B51	AN Perf Tack Fab-Cvr Pnl Skin	TS74218PF	B67	AN Tack Acst Pnl Pkg
TS73624TK	B53	AN Tack Fab-Cvr Pnl Skin	TS74218TF	B71	AN Tack Acst Pnl Pkg
TS73624WG	B58	AN Glass Window	TS74224PF	B67	AN Tack Acst Pnl Pkg
TS73624WP	B59	AN Pass-Thru Window	TS74224TF	B71	AN Tack Acst Pnl Pkg
TS73630HS	B55	AN Steel Panel Skin	TS74230PF	B67	AN Tack Acst Pnl Pkg
TS73630MBS	B56	AN Marker Brd Surface	TS74230TF	B71	AN Tack Acst Pnl Pkg
TS73630TA	B51	AN Perf Tack Fab-Cvr Pnl Skin	TS74236PF	B67	AN Tack Acst Pnl Pkg
TS73630TK	B53	AN Tack Fab-Cvr Pnl Skin	TS74236TF	B71	AN Tack Acst Pnl Pkg
TS73630WG	B58	AN Glass Window	TS74242PF	B67	AN Tack Acst Pnl Pkg
TS73630WP	B59	AN Pass-Thru Window	TS74242TF	B71	AN Tack Acst Pnl Pkg
TS73636HS	B55	AN Steel Panel Skin	TS74248PF	B67	AN Tack Acst Pnl Pkg
TS73636MBS	B56	AN Marker Brd Surface	TS74248TF	B71	AN Tack Acst Pnl Pkg
TS73636TA	B51	AN Perf Tack Fab-Cvr Pnl Skin	TS74260PF	B67	AN Tack Acst Pnl Pkg
TS73636TK	B53	AN Tack Fab-Cvr Pnl Skin	TS74260TF	B71	AN Tack Acst Pnl Pkg
TS73636WG	B58	AN Glass Window	TS74272PF	B67	AN Tack Acst Pnl Pkg
TS73636WP	B59	AN Pass-Thru Window	TS74272TF	B71	AN Tack Acst Pnl Pkg
TS73642HS	B55	AN Steel Panel Skin	TS742BKT	B32	AN Off-Module Conn
TS73642MBS	B56	AN Marker Brd Surface	TS742CT	B76	AN Cable Tray
TS73642TA	B51	AN Perf Tack Fab-Cvr Pnl Skin	TS742EPJ	B27	AN Junction
TS73642TK	B53	AN Tack Fab-Cvr Pnl Skin	TS742EPJW	B28	AN Junction
TS73642WG	B58	AN Glass Window	TS742ERUP	B41	AN Junct w/Util Pole
TS73642WP	B59	AN Pass-Thru Window	TS742HB	B137, B162, C155	Horizontal Brace
TS73648HS	B55	AN Steel Panel Skin	TS742HF	B46	AN Horiz Frame Pkg
TS73648MBS	B56	AN Marker Brd Surface	TS742HFS	B47	AN Horiz Frame Pkg
TS73648TA	B51	AN Perf Tack Fab-Cvr Pnl Skin	TS742IPJ	B24	AN Junction
TS73648TK	B53	AN Tack Fab-Cvr Pnl Skin	TS742LPJ	B25	AN Junction
TS73648WG	B58	AN Glass Window	TS742LPJW	B26	AN Junction
TS73648WP	B59	AN Pass-Thru Window	TS742LUP	B41	AN Junct w/Util Pole
TS73660HS	B55	AN Steel Panel Skin	TS742MP	B127	AN Modesty Panel
TS73660TA	B51	AN Perf Tack Fab-Cvr Pnl Skin	TS742SUC	B89	AN Ceil-Acc Lay-In Util Pkg
TS73660TK	B53	AN Tack Fab-Cvr Pnl Skin	TS742SUF	B90	AN Flr-Acc Lay-In Util Pkg
TS73672HS	B55	AN Steel Panel Skin	TS742TPJ	B25	AN Junction
TS73672TA	B51	AN Perf Tack Fab-Cvr Pnl Skin	TS742TPJW	B26	AN Junction
TS73672TK	B53	AN Tack Fab-Cvr Pnl Skin	TS742TUP	B41	AN Junct w/Util Pole
TS73672WT	B113	AN Oval Wksf	TS742VPJ	B29	AN Junction
TS73684WV	B104	AN Wave Wksf	TS742VPJW	B30	AN Junction
TS73696WV	B104	AN Wave Wksf	TS742WPJ	B31	AN Junction
TS736BKT	B32	AN Off-Module Conn	TS742XPJ	B25	AN Junction
TS736CH	B42	AN Change-of-Hgt Trim	TS742XPJW	B26	AN Junction
TS736CHS	B42	AN Change-of-Hgt Trim	TS742YPJ	B29	AN Junction
TS736CHSW	B43	AN Change-of-Hgt Trim	TS742YPJW	B30	AN Junction
TS736CHW	B43	AN Change-of-Hgt Trim	TS743MHX	B85	AN Modular Harness
TS736CP	B87	AN Consol Pt Door Skin	TS743MHY	B85	AN Modular Harness
TS736CT	B76	AN Cable Tray	TS743MHZ	B85	AN Modular Harness
TS736HF	B46	AN Horiz Frame Pkg	TS74818HS	B55	AN Steel Panel Skin
TS736HFS	B47	AN Horiz Frame Pkg	TS74818TA	B51	AN Perf Tack Fab-Cvr Pnl Skin
TS736MP	B127	AN Modesty Panel	TS74818TK	B53	AN Tack Fab-Cvr Pnl Skin
TS736SUC	B89	AN Ceil-Acc Lay-In Util Pkg	TS74824HS	B55	AN Steel Panel Skin
TS736SUF	B90	AN Flr-Acc Lay-In Util Pkg	TS74824TA	B51	AN Perf Tack Fab-Cvr Pnl Skin
TS73SGX	B80	AN 15-Amp Receptacle	TS74824TK	B53	AN Tack Fab-Cvr Pnl Skin
TS73SGY	B80	AN 15-Amp Receptacle	TS74824WG	B58	AN Glass Window
TS73SGZ	B81	AN 15-Amp Receptacle	TS74830HS	B55	AN Steel Panel Skin
TS73SSX	B80	AN 15-Amp Receptacle	TS74830TA	B51	AN Perf Tack Fab-Cvr Pnl Skin
TS73SSY	B80	AN 15-Amp Receptacle			

Style Number Index, continued

Style Number	Page	Description
TS74830TK	B53	AN Tack Fab-Cvr Pnl Skin
TS74830WG	B58	AN Glass Window
TS74836HS	B55	AN Steel Panel Skin
TS74836TA	B51	AN Perf Tack Fab-Cvr Pnl Skin
TS74836TK	B53	AN Tack Fab-Cvr Pnl Skin
TS74836WG	B58	AN Glass Window
TS74842TA	B51	AN Perf Tack Fab-Cvr Pnl Skin
TS74842TK	B53	AN Tack Fab-Cvr Pnl Skin
TS74842WG	B58	AN Glass Window
TS74848TA	B51	AN Perf Tack Fab-Cvr Pnl Skin
TS74848TK	B53	AN Tack Fab-Cvr Pnl Skin
TS74848WG	B58	AN Glass Window
TS74860TA	B51	AN Perf Tack Fab-Cvr Pnl Skin
TS74860TK	B53	AN Tack Fab-Cvr Pnl Skin
TS74872TA	B51	AN Perf Tack Fab-Cvr Pnl Skin
TS74872TK	B53	AN Tack Fab-Cvr Pnl Skin
TS748BKT	B32	AN Off-Module Conn
TS748CT	B76	AN Cable Tray
TS748HB	B137, B162, C155	Horizontal Brace
TS748HF	B46	AN Horiz Frame Pkg
TS748HFS	B47	AN Horiz Frame Pkg
TS748HR	B111	AN Spanner Wksf
TS748MP	B127	AN Modesty Panel
TS748SUC	B89	AN Ceil-Acc Lay-In Util Pkg
TS748SUF	B90	AN Flr-Acc Lay-In Util Pkg
TS74SGX	B80	AN 15-Amp Receptacle
TS74SGY	B80	AN 15-Amp Receptacle
TS74SSX	B80	AN 15-Amp Receptacle
TS74SSY	B80	AN 15-Amp Receptacle
TS750HRK	B121	AN Spanner Wksf
TS751HR	B110	AN Spanner Wksf
TS75418PF	B67	AN Tack Acst Pnl Pkg
TS75418TF	B71	AN Tack Acst Pnl Pkg
TS75424PF	B67	AN Tack Acst Pnl Pkg
TS75424TF	B71	AN Tack Acst Pnl Pkg
TS75430PF	B67	AN Tack Acst Pnl Pkg
TS75430TF	B71	AN Tack Acst Pnl Pkg
TS75436PF	B67	AN Tack Acst Pnl Pkg
TS75436TF	B71	AN Tack Acst Pnl Pkg
TS75442PF	B67	AN Tack Acst Pnl Pkg
TS75442TF	B71	AN Tack Acst Pnl Pkg
TS75448PF	B67	AN Tack Acst Pnl Pkg
TS75448TF	B71	AN Tack Acst Pnl Pkg
TS75460PF	B67	AN Tack Acst Pnl Pkg
TS75460TF	B71	AN Tack Acst Pnl Pkg
TS75472PF	B67	AN Tack Acst Pnl Pkg
TS75472TF	B71	AN Tack Acst Pnl Pkg
TS754EPJ	B27	AN Junction
TS754EPJW	B28	AN Junction
TS754ERUP	B41	AN Junct w/Util Pole
TS754IPJ	B24	AN Junction
TS754LPJ	B25	AN Junction
TS754LPJW	B26	AN Junction
TS754LUP	B41	AN Junct w/Util Pole

Style Number	Page	Description
TS754TPJ	B25	AN Junction
TS754TPJW	B26	AN Junction
TS754TUP	B41	AN Junct w/Util Pole
TS754VPJ	B29	AN Junction
TS754VPJW	B30	AN Junction
TS754WPJ	B31	AN Junction
TS754XPJ	B25	AN Junction
TS754XPJW	B26	AN Junction
TS754YPJ	B29	AN Junction
TS754YPJW	B30	AN Junction
TS76018HS	B55	AN Steel Panel Skin
TS76018TA	B51	AN Perf Tack Fab-Cvr Pnl Skin
TS76018TK	B53	AN Tack Fab-Cvr Pnl Skin
TS76024HS	B55	AN Steel Panel Skin
TS76024TA	B51	AN Perf Tack Fab-Cvr Pnl Skin
TS76024TK	B53	AN Tack Fab-Cvr Pnl Skin
TS76030HS	B55	AN Steel Panel Skin
TS76030TA	B51	AN Perf Tack Fab-Cvr Pnl Skin
TS76030TK	B53	AN Tack Fab-Cvr Pnl Skin
TS76036HS	B55	AN Steel Panel Skin
TS76036TA	B51	AN Perf Tack Fab-Cvr Pnl Skin
TS76036TK	B53	AN Tack Fab-Cvr Pnl Skin
TS76042TA	B51	AN Perf Tack Fab-Cvr Pnl Skin
TS76042TK	B53	AN Tack Fab-Cvr Pnl Skin
TS76048TA	B51	AN Perf Tack Fab-Cvr Pnl Skin
TS76048TK	B53	AN Tack Fab-Cvr Pnl Skin
TS76060TA	B51	AN Perf Tack Fab-Cvr Pnl Skin
TS76060TK	B53	AN Tack Fab-Cvr Pnl Skin
TS76072TA	B51	AN Perf Tack Fab-Cvr Pnl Skin
TS76072TK	B53	AN Tack Fab-Cvr Pnl Skin
TS760BKT	B32	AN Off-Module Conn
TS760CT	B76	AN Cable Tray
TS760HB	B137, B162, C155	Horizontal Brace
TS760HF	B46	AN Horiz Frame Pkg
TS760HFS	B47	AN Horiz Frame Pkg
TS760HR	B111	AN Spanner Wksf
TS760MP	B127	AN Modesty Panel
TS762HRK	B121	AN Spanner Wksf
TS763HR	B110	AN Spanner Wksf
TS76618PF	B69	AN Tack Acst Pnl Pkg
TS76618TF	B73	AN Tack Acst Pnl Pkg
TS76624PF	B69	AN Tack Acst Pnl Pkg
TS76624TF	B73	AN Tack Acst Pnl Pkg
TS76630PF	B69	AN Tack Acst Pnl Pkg
TS76630TF	B73	AN Tack Acst Pnl Pkg
TS76636PF	B69	AN Tack Acst Pnl Pkg
TS76636TF	B73	AN Tack Acst Pnl Pkg
TS76642PF	B69	AN Tack Acst Pnl Pkg
TS76642TF	B73	AN Tack Acst Pnl Pkg
TS76648PF	B69	AN Tack Acst Pnl Pkg
TS76648TF	B73	AN Tack Acst Pnl Pkg
TS76660PF	B69	AN Tack Acst Pnl Pkg
TS76660TF	B73	AN Tack Acst Pnl Pkg
TS76672PF	B69	AN Tack Acst Pnl Pkg

Style Number	Page	Description	Style Number	Page	Description
TS76672TF	B73	AN Tack Acst Pnl Pkg	TS7BMH	B161	AN Bracket for Bin
TS766EPJ	B27	AN Junction	TS7BPNY24X	B83	AN Power Infeed
TS766EPJW	B28	AN Junction	TS7BPNY24Y	B83	AN Power Infeed
TS766ERUP	B41	AN Junct w/Util Pole	TS7BPNY24Z	B83	AN Power Infeed
TS766IPJ	B24	AN Junction	TS7BPNY30X	B83	AN Power Infeed
TS766LPJ	B25	AN Junction	TS7BPNY30Y	B83	AN Power Infeed
TS766LPJW	B26	AN Junction	TS7BPNY30Z	B83	AN Power Infeed
TS766LUP	B41	AN Junct w/Util Pole	TS7BPNY36X	B83	AN Power Infeed
TS766TPJ	B25	AN Junction	TS7BPNY36Y	B83	AN Power Infeed
TS766TPJW	B26	AN Junction	TS7BPNY36Z	B83	AN Power Infeed
TS766TUP	B41	AN Junct w/Util Pole	TS7BPNY42X	B83	AN Power Infeed
TS766VPJ	B29	AN Junction	TS7BPNY42Y	B83	AN Power Infeed
TS766VPJW	B30	AN Junction	TS7BPNY42Z	B83	AN Power Infeed
TS766WPJ	B31	AN Junction	TS7BPNY48X	B83	AN Power Infeed
TS766XPJ	B25	AN Junction	TS7BPNY48Y	B83	AN Power Infeed
TS766XPJW	B26	AN Junction	TS7BPNY48Z	B83	AN Power Infeed
TS766YPJ	B29	AN Junction	TS7BPNY60X	B83	AN Power Infeed
TS766YPJW	B30	AN Junction	TS7BPNY60Y	B83	AN Power Infeed
TS76BPX	B82	AN Power Infeed	TS7BPNY60Z	B83	AN Power Infeed
TS76BPY	B82	AN Power Infeed	TS7BPNY72X	B83	AN Power Infeed
TS76BPZ	B82	AN Power Infeed	TS7BPNY72Y	B83	AN Power Infeed
TS772BKT	B32	AN Off-Module Conn	TS7BPNY72Z	B83	AN Power Infeed
TS772CT	B76	AN Cable Tray	TS7BSWHC	B136, B162, C154	Wall Channels
TS772HB	B137, B162, C155	Horizontal Brace	TS7CANT	B125	AN Cantilever w/Tie Plate
TS772HF	B46	AN Horiz Frame Pkg	TS7CKBC42	B117	AN Adj-Hgt BL Cor Wksf
TS772HFS	B47	AN Horiz Frame Pkg	TS7CKBC48	B117	AN Adj-Hgt BL Cor Wksf
TS772MP	B127	AN Modesty Panel	TS7CKBS42	B117	AN Adj-Hgt BL Str Wksf
TS772RC	B125	Reinforcing Channel	TS7CKBS48	B117	AN Adj-Hgt BL Str Wksf
TS772TR	B111	AN Trapezoid Table	TS7CKDC42	B117	AN Adj-Hgt Dual Cor Wksf
TS778EPJ	B27	AN Junction	TS7CKDC48	B117	AN Adj-Hgt Dual Cor Wksf
TS778EPJW	B28	AN Junction	TS7CKDS42	B117	AN Adj-Hgt Dual Str Wksf
TS778ERUP	B41	AN Junct w/Util Pole	TS7CKDS48	B117	AN Adj-Hgt Dual Str Wksf
TS778IPJ	B24	AN Junction	TS7CKEL24	B118	AN Adj-Hgt Ext Link Wksf
TS778LPJ	B25	AN Junction	TS7CKEL36	B118	AN Adj-Hgt Ext Link Wksf
TS778LPJW	B26	AN Junction	TS7CKER24	B118	AN Adj-Hgt Ext Link Wksf
TS778LUP	B41	AN Junct w/Util Pole	TS7CKER36	B118	AN Adj-Hgt Ext Link Wksf
TS778TPJ	B25	AN Junction	TS7CKSC42	B117	AN Adj-Hgt Cor Wksf
TS778TPJW	B26	AN Junction	TS7CKSC48	B117	AN Adj-Hgt Cor Wksf
TS778TUP	B41	AN Junct w/Util Pole	TS7CKSS42	B117	AN Adj-Hgt Str Wksf
TS778VPJ	B29	AN Junction	TS7CKSS48	B117	AN Adj-Hgt Str Wksf
TS778VPJW	B30	AN Junction	TS7CL	B124, D45	C-Leg
TS778WPJ	B31	AN Junction	TS7CLB	B124	C-Leg
TS778XPJ	B25	AN Junction	TS7CPCM	B88	AN Consol Pt Cbl Mgr
TS778XPJW	B26	AN Junction	TS7CPK	B88	AN Consol Point Kit
TS778YPJ	B29	AN Junction	TS7CPK24	B84	AN Powerkit
TS778YPJW	B30	AN Junction	TS7CPK30	B84	AN Powerkit
TS780MHX	B85	AN Modular Harness	TS7CPK36	B84	AN Powerkit
TS780MHY	B85	AN Modular Harness	TS7CPK42	B84	AN Powerkit
TS780MHZ	B85	AN Modular Harness	TS7CPK48	B84	AN Powerkit
TS7AB	B48	AN Adjustable Brace	TS7CPK60	B84	AN Powerkit
TS7AV	B161	AN Bracket for Bin	TS7CPK72	B84	AN Powerkit
TS7AVH	B161	AN Bracket for Bin	TS7CPMB	B88	AN Consol Pt Mtg Brkt
TS7BDPT	B157	AN Pencil Tray	TS7CPS	B125	AN Center Support Panel
TS7BM	B161	AN Bracket for Bin	TS7CST	B128	AN Cable Storage Tray

Style Number Index, continued

Style Number	Page	Description
TS7CTRPNL	B125	AN Center Support Panel
TS7DPL	B124, D45	Double Post Leg
TS7DPLS	B124, D45	Double Post Leg
TS7ECDC42	B119	AN Adj-Hgt Dual Cor Wksf
TS7ECDC48	B119	AN Adj-Hgt Dual Cor Wksf
TS7ECDS42	B119	AN Adj-Hgt Dual Str Wksf
TS7ECDS48	B119	AN Adj-Hgt Dual Str Wksf
TS7ECSC42	B119	AN Adj-Hgt Cor Wksf
TS7ECSC48	B119	AN Adj-Hgt Cor Wksf
TS7ECSS42	B119	AN Adj-Hgt Str Wksf
TS7ECSS48	B119	AN Adj-Hgt Str Wksf
TS7FSLVE	B86	AN Horizontal Cbl Sleeve
TS7GC	B117	AN Gas Cylinders
TS7HSLVE	B86	AN Grommet for Horiz Bar
TS7JSLVE	B86	AN Grommet for Junction
TS7LSLVE	B85	AN Junct Cbl Sleeve
TS7LWM	B128, C145, D99	Leg Wire Manager
TS7MPP	B127	AN Ped-to-Mod Panel Filler
TS7MTPK	B163	AN Hanging Kit
TS7NPL	B124, D45	Nesting Post Leg
TS7NPLC	B124, D45	Nesting Post Leg w/Caster
TS7PCTC	B64	AN Technology Cover
TS7PK24X	B77	AN Powerkit
TS7PK24Y	B77	AN Powerkit
TS7PK24Z	B77	AN Powerkit
TS7PK30X	B77	AN Powerkit
TS7PK30Y	B77	AN Powerkit
TS7PK30Z	B77	AN Powerkit
TS7PK36X	B77	AN Powerkit
TS7PK36Y	B77	AN Powerkit
TS7PK36Z	B77	AN Powerkit
TS7PK42X	B77	AN Powerkit
TS7PK42Y	B77	AN Powerkit
TS7PK42Z	B77	AN Powerkit
TS7PK48X	B77	AN Powerkit
TS7PK48Y	B77	AN Powerkit
TS7PK48Z	B77	AN Powerkit
TS7PK60X	B77	AN Powerkit
TS7PK60Y	B77	AN Powerkit
TS7PK60Z	B77	AN Powerkit
TS7PK72X	B77	AN Powerkit
TS7PK72Y	B77	AN Powerkit
TS7PK72Z	B77	AN Powerkit
TS7PT18X	B78	AN Pass-Thru Powerkit
TS7PT18Y	B78	AN Pass-Thru Powerkit
TS7PT18Z	B78	AN Pass-Thru Powerkit
TS7PT24X	B78	AN Pass-Thru Powerkit
TS7PT24Y	B78	AN Pass-Thru Powerkit
TS7PT24Z	B78	AN Pass-Thru Powerkit
TS7PT30X	B78	AN Pass-Thru Powerkit
TS7PT30Y	B78	AN Pass-Thru Powerkit
TS7PT30Z	B78	AN Pass-Thru Powerkit
TS7PT36X	B78	AN Pass-Thru Powerkit
TS7PT36Y	B78	AN Pass-Thru Powerkit

Style Number	Page	Description
TS7PT36Z	B78	AN Pass-Thru Powerkit
TS7PT42X	B78	AN Pass-Thru Powerkit
TS7PT42Y	B78	AN Pass-Thru Powerkit
TS7PT42Z	B78	AN Pass-Thru Powerkit
TS7PT48X	B78	AN Pass-Thru Powerkit
TS7PT48Y	B78	AN Pass-Thru Powerkit
TS7PT48Z	B78	AN Pass-Thru Powerkit
TS7PT60X	B78	AN Pass-Thru Powerkit
TS7PT60Y	B78	AN Pass-Thru Powerkit
TS7PT60Z	B78	AN Pass-Thru Powerkit
TS7PT72X	B78	AN Pass-Thru Powerkit
TS7PT72Y	B78	AN Pass-Thru Powerkit
TS7PT72Z	B78	AN Pass-Thru Powerkit
TS7PTC	B64	AN Technology Cover
TS7PVWM	B178	Vert Wire Manager
TS7SPL	B124, D45	Single Post Leg
TS7SPLC	B124, D45	Single Post Leg w/Caster
TS7SPLS	B124, D45	Single Post Leg
TS7STDIV	B138, B161, C156	Dividers
TS7TIEPLATE	B125, D39	Tie Plates
TS7UFPLATE	B82	AN Face Plate
TS7WKSPT	B125, D40	Reinforcing Channel
TS7WWM	B128, D96	Wksf Wire Manager
TU720BBFL	B151	AN Pedestal
TU720FFL	B151	AN Pedestal
TU726BBFL	B151	AN Pedestal
TU726FFL	B151	AN Pedestal
TU7BBFM	B153	AN Mobile Pedestal
TU7FFM	B153	AN Mobile Pedestal
TU7MOBILE	B153	AN Mobile Pedestal
UB223636_	D16	Univ Sys Corner, 120° Wksf
UB224242_	D16	Univ Sys Corner, 120° Wksf
UB224242K_	D17	Univ Sys Corner, 120° Wksf
UB224848_	D16	Univ Sys Corner, 120° Wksf
UB224848K_	D17	Univ Sys Corner, 120° Wksf
UB333636_	D16	Univ Sys Corner, 120° Wksf
UB334242_	D16	Univ Sys Corner, 120° Wksf
UB334242K_	D17	Univ Sys Corner, 120° Wksf
UB334848_	D16	Univ Sys Corner, 120° Wksf
UB334848K_	D17	Univ Sys Corner, 120° Wksf
UC114242_	D6	Univ Sys Cor Str-Front Wksf
UC124242_	D6	Univ Sys Cor Str-Front Wksf
UC214242_	D6	Univ Sys Cor Str-Front Wksf
UC223636_	D6	Univ Sys Cor Str-Front Wksf
UC224242_	D6	Univ Sys Cor Str-Front Wksf
UC224848_	D6	Univ Sys Cor Str-Front Wksf
UC224848K_	D7	Univ Sys Cor Str-Front Wksf
UC226060_	D6	Univ Sys Cor Str-Front Wksf
UC226060K_	D7	Univ Sys Cor Str-Front Wksf
UC334242_	D6	Univ Sys Cor Str-Front Wksf
UC334848_	D6	Univ Sys Cor Str-Front Wksf
UCANT	D38	Univ Sys On-Module Cantilever
UCANTOM	D38	Univ Sys Off-Module Cantilever

Style Number	Page	Description	Style Number	Page	Description
UCC114242_	D8	Univ Sys Cor Crvd-Front Wksf	UE3268L_	D11	Univ Sys Ext Cor Str-Front Wksf
UCC124242_	D8	Univ Sys Cor Crvd-Front Wksf	UE3280R_	D11	Univ Sys Ext Cor Str-Front Wksf
UCC214242_	D8	Univ Sys Cor Crvd-Front Wksf	UE3282R_	D11	Univ Sys Ext Cor Str-Front Wksf
UCC223636_	D8	Univ Sys Cor Crvd-Front Wksf	UE3286R_	D11	Univ Sys Ext Cor Str-Front Wksf
UCC224242_	D8	Univ Sys Cor Crvd-Front Wksf	UE3308L_	D11	Univ Sys Ext Cor Str-Front Wksf
UCC224848_	D8	Univ Sys Cor Crvd-Front Wksf	UE3328L_	D11	Univ Sys Ext Cor Str-Front Wksf
UCC226060_	D8	Univ Sys Cor Crvd-Front Wksf	UE3368L_	D11	Univ Sys Ext Cor Str-Front Wksf
UCC334242_	D8	Univ Sys Cor Crvd-Front Wksf	UE3380R_	D11	Univ Sys Ext Cor Str-Front Wksf
UCC334848_	D8	Univ Sys Cor Crvd-Front Wksf	UE3382R_	D11	Univ Sys Ext Cor Str-Front Wksf
UCKBC42_	D32	Univ Sys Adjustable-Hgt Wksf	UE3386R_	D11	Univ Sys Ext Cor Str-Front Wksf
UCKBC48_	D32	Univ Sys Adjustable-Hgt Wksf	UEC2202L_	D15	Univ Sys Ext Cor Crvd-Front Wksf
UCKBS42_	D33	Univ Sys Adjustable-Hgt Wksf	UEC2208L_	D15	Univ Sys Ext Cor Crvd-Front Wksf
UCKBS48_	D33	Univ Sys Adjustable-Hgt Wksf	UEC2220R_	D15	Univ Sys Ext Cor Crvd-Front Wksf
UCKDC42_	D32	Univ Sys Adjustable-Hgt Wksf	UEC2222L_	D15	Univ Sys Ext Cor Crvd-Front Wksf
UCKDC48_	D32	Univ Sys Adjustable-Hgt Wksf	UEC2222R_	D15	Univ Sys Ext Cor Crvd-Front Wksf
UCKDS42_	D33	Univ Sys Adjustable-Hgt Wksf	UEC2226R_	D15	Univ Sys Ext Cor Crvd-Front Wksf
UCKDS48_	D33	Univ Sys Adjustable-Hgt Wksf	UEC2228L_	D15	Univ Sys Ext Cor Crvd-Front Wksf
UCKEL24_	D34	Univ Sys Adj-Hgt Ext Link Wksf	UEC2228R_	D15	Univ Sys Ext Cor Crvd-Front Wksf
UCKEL36_	D34	Univ Sys Adj-Hgt Ext Link Wksf	UEC2262L_	D15	Univ Sys Ext Cor Crvd-Front Wksf
UCKER24_	D34	Univ Sys Adj-Hgt Ext Link Wksf	UEC2268L_	D15	Univ Sys Ext Cor Crvd-Front Wksf
UCKER36_	D34	Univ Sys Adj-Hgt Ext Link Wksf	UEC2280R_	D15	Univ Sys Ext Cor Crvd-Front Wksf
UCKSC42_	D32	Univ Sys Adjustable-Hgt Wksf	UEC2282R_	D15	Univ Sys Ext Cor Crvd-Front Wksf
UCKSC48_	D32	Univ Sys Adjustable-Hgt Wksf	UEC2286R_	D15	Univ Sys Ext Cor Crvd-Front Wksf
UCKSS42_	D33	Univ Sys Adjustable-Hgt Wksf	UEC2308L_	D15	Univ Sys Ext Cor Crvd-Front Wksf
UCKSS48_	D33	Univ Sys Adjustable-Hgt Wksf	UEC2328L_	D15	Univ Sys Ext Cor Crvd-Front Wksf
UCSP	D40	Univ Sys On-Module Center Sprt Pnl	UEC2368L_	D15	Univ Sys Ext Cor Crvd-Front Wksf
UCSPOM	D40	Univ Sys Off-Module Center Sprt Pnl	UEC2380R_	D15	Univ Sys Ext Cor Crvd-Front Wksf
UCSPS	D40	Univ Sys On-Module Center Sprt Pnl	UEC2382R_	D15	Univ Sys Ext Cor Crvd-Front Wksf
UCSPSOM	D40	Univ Sys Off-Module Center Sprt Pnl	UEC2386R_	D15	Univ Sys Ext Cor Crvd-Front Wksf
UE2202L_	D11	Univ Sys Ext Cor Str-Front Wksf	UEC3208L_	D15	Univ Sys Ext Cor Crvd-Front Wksf
UE2208KL_	D12	Univ Sys Ext Cor Str-Front Wksf	UEC3228L_	D15	Univ Sys Ext Cor Crvd-Front Wksf
UE2208L_	D11	Univ Sys Ext Cor Str-Front Wksf	UEC3268L_	D15	Univ Sys Ext Cor Crvd-Front Wksf
UE2220R_	D11	Univ Sys Ext Cor Str-Front Wksf	UEC3280R_	D15	Univ Sys Ext Cor Crvd-Front Wksf
UE2222L_	D11	Univ Sys Ext Cor Str-Front Wksf	UEC3282R_	D15	Univ Sys Ext Cor Crvd-Front Wksf
UE2222R_	D11	Univ Sys Ext Cor Str-Front Wksf	UEC3286R_	D15	Univ Sys Ext Cor Crvd-Front Wksf
UE2226R_	D11	Univ Sys Ext Cor Str-Front Wksf	UEC3308L_	D15	Univ Sys Ext Cor Crvd-Front Wksf
UE2228KL_	D12	Univ Sys Ext Cor Str-Front Wksf	UEC3328L_	D15	Univ Sys Ext Cor Crvd-Front Wksf
UE2228L_	D11	Univ Sys Ext Cor Str-Front Wksf	UEC3368L_	D15	Univ Sys Ext Cor Crvd-Front Wksf
UE2262L_	D11	Univ Sys Ext Cor Str-Front Wksf	UEC3380R_	D15	Univ Sys Ext Cor Crvd-Front Wksf
UE2268KL_	D12	Univ Sys Ext Cor Str-Front Wksf	UEC3382R_	D15	Univ Sys Ext Cor Crvd-Front Wksf
UE2268L_	D11	Univ Sys Ext Cor Str-Front Wksf	UEC3386R_	D15	Univ Sys Ext Cor Crvd-Front Wksf
UE2280KR_	D12	Univ Sys Ext Cor Str-Front Wksf	UECDC42_	D37	Univ Sys Adjustable-Hgt Wksf
UE2280R_	D11	Univ Sys Ext Cor Str-Front Wksf	UECDC48_	D37	Univ Sys Adjustable-Hgt Wksf
UE2282KR_	D12	Univ Sys Ext Cor Str-Front Wksf	UECDS42_	D37	Univ Sys Adjustable-Hgt Wksf
UE2282R_	D11	Univ Sys Ext Cor Str-Front Wksf	UECDS48_	D37	Univ Sys Adjustable-Hgt Wksf
UE2286KR_	D12	Univ Sys Ext Cor Str-Front Wksf	UECSC42_	D37	Univ Sys Adjustable-Hgt Wksf
UE2286R_	D11	Univ Sys Ext Cor Str-Front Wksf	UECSC48_	D37	Univ Sys Adjustable-Hgt Wksf
UE2308L_	D11	Univ Sys Ext Cor Str-Front Wksf	UECSS42_	D37	Univ Sys Adjustable-Hgt Wksf
UE2328L_	D11	Univ Sys Ext Cor Str-Front Wksf	UECSS48_	D37	Univ Sys Adjustable-Hgt Wksf
UE2368L_	D11	Univ Sys Ext Cor Str-Front Wksf	UEP24	D41	Univ Sys On-Module End Panel
UE2380R_	D11	Univ Sys Ext Cor Str-Front Wksf	UEP24OM	D41	Univ Sys Off-Module End Panel
UE2382R_	D11	Univ Sys Ext Cor Str-Front Wksf	UEP24S	D41	Univ Sys On-Module End Panel
UE2386R_	D11	Univ Sys Ext Cor Str-Front Wksf	UEP24SOM	D41	Univ Sys Off-Module End Panel
UE3208L_	D11	Univ Sys Ext Cor Str-Front Wksf	UEP30	D41	Univ Sys On-Module End Panel
UE3228L_	D11	Univ Sys Ext Cor Str-Front Wksf	UEP30OM	D41	Univ Sys Off-Module End Panel
			UEP30S	D41	Univ Sys On-Module End Panel

Style Number Index, continued

Style Number	Page	Description
UEP30SOM	D41	Univ Sys Off-Module End Panel
UGC	D33	Univ Sys Pair of Gas Cylinders
UJ2382R_	D23	Univ Sys Jetty Str-Front Wksf
UJ2386R_	D23	Univ Sys Jetty Str-Front Wksf
UJ2388R_	D23	Univ Sys Jetty Str-Front Wksf
UJ3228L_	D23	Univ Sys Jetty Str-Front Wksf
UJ3268L_	D23	Univ Sys Jetty Str-Front Wksf
UJ3288L_	D23	Univ Sys Jetty Str-Front Wksf
UJ3328L_	D23	Univ Sys Jetty Str-Front Wksf
UJ3368L_	D23	Univ Sys Jetty Str-Front Wksf
UJ3382R_	D23	Univ Sys Jetty Str-Front Wksf
UJ3386R_	D23	Univ Sys Jetty Str-Front Wksf
UJ3388L_	D23	Univ Sys Jetty Str-Front Wksf
UJ3388R_	D23	Univ Sys Jetty Str-Front Wksf
UJBC2430L_	D25	Univ Sys Bubble Jetty Wksf
UJBC2430R_	D25	Univ Sys Bubble Jetty Wksf
UJBC2436L_	D25	Univ Sys Bubble Jetty Wksf
UJBC2436R_	D25	Univ Sys Bubble Jetty Wksf
UJBC2442L_	D25	Univ Sys Bubble Jetty Wksf
UJBC2442R_	D25	Univ Sys Bubble Jetty Wksf
UJBC2448L_	D25	Univ Sys Bubble Jetty Wksf
UJBC2448R_	D25	Univ Sys Bubble Jetty Wksf
UJC2382R_	D24	Univ Sys Jetty Crvd-Front Wksf
UJC2386R_	D24	Univ Sys Jetty Crvd-Front Wksf
UJC2388R_	D24	Univ Sys Jetty Crvd-Front Wksf
UJC3228L_	D24	Univ Sys Jetty Crvd-Front Wksf
UJC3268L_	D24	Univ Sys Jetty Crvd-Front Wksf
UJC3288L_	D24	Univ Sys Jetty Crvd-Front Wksf
UJC3328L_	D24	Univ Sys Jetty Crvd-Front Wksf
UJC3368L_	D24	Univ Sys Jetty Crvd-Front Wksf
UJC3382R_	D24	Univ Sys Jetty Crvd-Front Wksf
UJC3386R_	D24	Univ Sys Jetty Crvd-Front Wksf
UJC3388L_	D24	Univ Sys Jetty Crvd-Front Wksf
UJC3388R_	D24	Univ Sys Jetty Crvd-Front Wksf
UL2626_	D27	Univ Sys Linking Str-Front Wksf
UL2727_	D27	Univ Sys Linking Str-Front Wksf
UL2828_	D27	Univ Sys Linking Str-Front Wksf
ULC2626_	D29	Univ Sys Linking Crvd-Front Wksf
ULC2727_	D29	Univ Sys Linking Crvd-Front Wksf
ULC2828_	D29	Univ Sys Linking Crvd-Front Wksf
UPA2648_	D21	Univ Sys Ang Penin Str-Front Wksf
UPA2748_	D21	Univ Sys Ang Penin Str-Front Wksf
UPA2848_	D21	Univ Sys Ang Penin Str-Front Wksf
UPAC2648_	D22	Univ Sys Ang Penin Crvd-Front Wksf
UPAC2748_	D22	Univ Sys Ang Penin Crvd-Front Wksf
UPAC2848_	D22	Univ Sys Ang Penin Crvd-Front Wksf
UPB3060_	D19	Univ Sys Bullet Penin Str-Front Wksf
UPB3066_	D19	Univ Sys Bullet Penin Str-Front Wksf
UPB3072_	D19	Univ Sys Bullet Penin Str-Front Wksf
UPBC3060_	D20	Univ Sys Bullet Penin Crvd-Front Wksf
UPBC3066_	D20	Univ Sys Bullet Penin Crvd-Front Wksf
UPBC3072_	D20	Univ Sys Bullet Penin Crvd-Front Wksf
UPF24	B156	AN Pathways Filler
UPF30	B156	AN Pathways Filler
US1830_	D3	Univ Sys Straight Wksf

Style Number	Page	Description
US1836_	D3	Univ Sys Straight Wksf
US1842_	D3	Univ Sys Straight Wksf
US1848_	D3	Univ Sys Straight Wksf
US1854_	D3	Univ Sys Straight Wksf
US1860_	D3	Univ Sys Straight Wksf
US2424_	D3	Univ Sys Straight Wksf
US2430_	D3	Univ Sys Straight Wksf
US2436_	D3	Univ Sys Straight Wksf
US2442_	D3	Univ Sys Straight Wksf
US2448_	D3	Univ Sys Straight Wksf
US2454_	D3	Univ Sys Straight Wksf
US2460_	D3	Univ Sys Straight Wksf
US2466_	D3	Univ Sys Straight Wksf
US2472_	D3	Univ Sys Straight Wksf
US3024_	D3	Univ Sys Straight Wksf
US3030_	D3	Univ Sys Straight Wksf
US3036_	D3	Univ Sys Straight Wksf
US3042_	D3	Univ Sys Straight Wksf
US3048_	D3	Univ Sys Straight Wksf
US3054_	D3	Univ Sys Straight Wksf
US3060_	D3	Univ Sys Straight Wksf
US3066_	D3	Univ Sys Straight Wksf
US3072_	D3	Univ Sys Straight Wksf
USPC47_	D18	Univ Sys Spanner Wksf
USPC50_	D18	Univ Sys Spanner Wksf
USPC51_	D18	Univ Sys Spanner Wksf
USPC52_	D18	Univ Sys Spanner Wksf
USPC59_	D18	Univ Sys Spanner Wksf
USPC62_	D18	Univ Sys Spanner Wksf
USPC63_	D18	Univ Sys Spanner Wksf
USPC64_	D18	Univ Sys Spanner Wksf
USSBR	D39	Univ Sys Side Support Brackets
UT1236R_	D5	Univ Sys Transition Wksf
UT1242R_	D5	Univ Sys Transition Wksf
UT1248R_	D5	Univ Sys Transition Wksf
UT1254R_	D5	Univ Sys Transition Wksf
UT1260R_	D5	Univ Sys Transition Wksf
UT2136L_	D5	Univ Sys Transition Wksf
UT2142L_	D5	Univ Sys Transition Wksf
UT2148L_	D5	Univ Sys Transition Wksf
UT2154L_	D5	Univ Sys Transition Wksf
UT2160L_	D5	Univ Sys Transition Wksf
UT2336R_	D5	Univ Sys Transition Wksf
UT2342R_	D5	Univ Sys Transition Wksf
UT2348R_	D5	Univ Sys Transition Wksf
UT2354R_	D5	Univ Sys Transition Wksf
UT2360R_	D5	Univ Sys Transition Wksf
UT3236L_	D5	Univ Sys Transition Wksf
UT3242L_	D5	Univ Sys Transition Wksf
UT3248L_	D5	Univ Sys Transition Wksf
UT3254L_	D5	Univ Sys Transition Wksf
UT3260L_	D5	Univ Sys Transition Wksf
UTR1630A_	D31	Univ Sys Transaction Wksf
UTR1630K_	D31	Univ Sys Transaction Wksf
UTR1630M_	D31	Univ Sys Transaction Wksf

Style Number	Page	Description	Style Number	Page	Description
UTR1630P	D31	Univ Sys Transaction Wksf	Z1TPI24	C74	MT Power Harness
UTR1636A	D31	Univ Sys Transaction Wksf	Z2BDT	C75	MT Modular Harness
UTR1636K	D31	Univ Sys Transaction Wksf	Z2TPI12	C74	MT Power Harness
UTR1636M	D31	Univ Sys Transaction Wksf	Z2TPI24	C74	MT Power Harness
UTR1636P	D31	Univ Sys Transaction Wksf	Z3BDT	C75	MT Modular Harness
UTR1642A	D31	Univ Sys Transaction Wksf	Z3TPI12	C74	MT Power Harness
UTR1642K	D31	Univ Sys Transaction Wksf	Z3TPI24	C74	MT Power Harness
UTR1642M	D31	Univ Sys Transaction Wksf	ZAAH	C121	MT Art Hook
UTR1642P	D31	Univ Sys Transaction Wksf	ZAP	C139, D45	Adjustable Column
UTR1648A	D31	Univ Sys Transaction Wksf	ZB1BPI12	C72	MT Power Infeed
UTR1648K	D31	Univ Sys Transaction Wksf	ZB1BPI6	C72	MT Power Infeed
UTR1648M	D31	Univ Sys Transaction Wksf	ZB1BPNY	C73	MT Power Infeed
UTR1648P	D31	Univ Sys Transaction Wksf	ZB1BPNY30	C73	MT Power Infeed
UTR1660A	D31	Univ Sys Transaction Wksf	ZB1PJ12	C75	MT Modular Jumper
UTR1660K	D31	Univ Sys Transaction Wksf	ZB1PTR24	C71	MT Pass-Thru Powerkit
UTR1660M	D31	Univ Sys Transaction Wksf	ZB1PTR30	C71	MT Pass-Thru Powerkit
UTR1660P	D31	Univ Sys Transaction Wksf	ZB1PTR36	C71	MT Pass-Thru Powerkit
UV2424L	D27	Univ Sys Visitor Str-Front Wksf	ZB1PTR42	C71	MT Pass-Thru Powerkit
UV2424R	D27	Univ Sys Visitor Str-Front Wksf	ZB1PTR48	C71	MT Pass-Thru Powerkit
UV2430L	D27	Univ Sys Visitor Str-Front Wksf	ZB1PW24	C70	MT Powerkit
UV2430R	D27	Univ Sys Visitor Str-Front Wksf	ZB1PW30	C70	MT Powerkit
UV2436L	D27	Univ Sys Visitor Str-Front Wksf	ZB1PW36	C70	MT Powerkit
UV2436R	D27	Univ Sys Visitor Str-Front Wksf	ZB1PW42	C70	MT Powerkit
UV2442L	D27	Univ Sys Visitor Str-Front Wksf	ZB1PW48	C70	MT Powerkit
UV2442R	D27	Univ Sys Visitor Str-Front Wksf	ZB1R1IG	C78	MT 15-Amp Receptacle
UV2448L	D27	Univ Sys Visitor Str-Front Wksf	ZB1R1IGH	B80, C79	20-Amp Receptacle
UV2448R	D27	Univ Sys Visitor Str-Front Wksf	ZB1R1SG	C78	MT 15-Amp Receptacle
UV3030L	D27	Univ Sys Visitor Str-Front Wksf	ZB1R1SGH	B80, C79	20-Amp Receptacle
UV3030R	D27	Univ Sys Visitor Str-Front Wksf	ZB1R2IG	C78	MT 15-Amp Receptacle
UV3036L	D27	Univ Sys Visitor Str-Front Wksf	ZB1R2IGH	B80, C79	20-Amp Receptacle
UV3036R	D27	Univ Sys Visitor Str-Front Wksf	ZB1R2SG	C78	MT 15-Amp Receptacle
UV3042L	D27	Univ Sys Visitor Str-Front Wksf	ZB1R2SGH	B80, C79	20-Amp Receptacle
UV3042R	D27	Univ Sys Visitor Str-Front Wksf	ZB1R3IG	C78	MT 15-Amp Receptacle
UV3048L	D27	Univ Sys Visitor Str-Front Wksf	ZB1R3IGH	B80, C79	20-Amp Receptacle
UV3048R	D27	Univ Sys Visitor Str-Front Wksf	ZB1R3SG	C78	MT 15-Amp Receptacle
UVC2424L	D29	Univ Sys Visitor Crvd-Front Wksf	ZB1R3SGH	B80, C79	20-Amp Receptacle
UVC2424R	D29	Univ Sys Visitor Crvd-Front Wksf	ZB1R4IG	C78	MT 15-Amp Receptacle
UVC2430L	D29	Univ Sys Visitor Crvd-Front Wksf	ZB1R4IGH	B80, C79	20-Amp Receptacle
UVC2430R	D29	Univ Sys Visitor Crvd-Front Wksf	ZB1R4SG	C78	MT 15-Amp Receptacle
UVC2436L	D29	Univ Sys Visitor Crvd-Front Wksf	ZB1R4SGH	B80, C79	20-Amp Receptacle
UVC2436R	D29	Univ Sys Visitor Crvd-Front Wksf	ZB2BPI12	C72	MT Power Infeed
UVC2442L	D29	Univ Sys Visitor Crvd-Front Wksf	ZB2BPI6	C72	MT Power Infeed
UVC2442R	D29	Univ Sys Visitor Crvd-Front Wksf	ZB2BPNY	C73	MT Power Infeed
UVC2448L	D29	Univ Sys Visitor Crvd-Front Wksf	ZB2BPNY30	C73	MT Power Infeed
UVC2448R	D29	Univ Sys Visitor Crvd-Front Wksf	ZB2PJ12	C75	MT Modular Jumper
UVC3030L	D29	Univ Sys Visitor Crvd-Front Wksf	ZB2PTR24	C71	MT Pass-Thru Powerkit
UVC3030R	D29	Univ Sys Visitor Crvd-Front Wksf	ZB2PTR30	C71	MT Pass-Thru Powerkit
UVC3036L	D29	Univ Sys Visitor Crvd-Front Wksf	ZB2PTR36	C71	MT Pass-Thru Powerkit
UVC3036R	D29	Univ Sys Visitor Crvd-Front Wksf	ZB2PTR42	C71	MT Pass-Thru Powerkit
UVC3042L	D29	Univ Sys Visitor Crvd-Front Wksf	ZB2PTR48	C71	MT Pass-Thru Powerkit
UVC3042R	D29	Univ Sys Visitor Crvd-Front Wksf	ZB2PW24	C70	MT Powerkit
UVC3048L	D29	Univ Sys Visitor Crvd-Front Wksf	ZB2PW24R	C76	MT Retrofit Powerkit
UVC3048R	D29	Univ Sys Visitor Crvd-Front Wksf	ZB2PW30	C70	MT Powerkit
Z1BDT	C75	MT Modular Harness	ZB2PW30R	C76	MT Retrofit Powerkit
Z1TPI12	C74	MT Power Harness	ZB2PW36	C70	MT Powerkit

Style Number Index, continued

Style Number	Page	Description
ZB2PW36R	C76	MT Retrofit Powerkit
ZB2PW42	C70	MT Powerkit
ZB2PW42R	C76	MT Retrofit Powerkit
ZB2PW48	C70	MT Powerkit
ZB2PW48R	C76	MT Retrofit Powerkit
ZB2R1IG	C78	MT 15-Amp Receptacle
ZB2R1IGH	B80, C79	20-Amp Receptacle
ZB2R1SG	C78	MT 15-Amp Receptacle
ZB2R1SGH	B80, C79	20-Amp Receptacle
ZB2R2IG	C78	MT 15-Amp Receptacle
ZB2R2IGH	B80, C79	20-Amp Receptacle
ZB2R2SG	C78	MT 15-Amp Receptacle
ZB2R2SGH	B80, C79	20-Amp Receptacle
ZB2R3IG	C78	MT 15-Amp Receptacle
ZB2R3IGH	B80, C79	20-Amp Receptacle
ZB2R3SG	C78	MT 15-Amp Receptacle
ZB2R3SGH	B80, C79	20-Amp Receptacle
ZB2R4IG	C78	MT 15-Amp Receptacle
ZB2R4IGH	B80, C79	20-Amp Receptacle
ZB2R4SG	C78	MT 15-Amp Receptacle
ZB2R4SGH	B80, C79	20-Amp Receptacle
ZB3BPI12	C72	MT Power Infeed
ZB3BPI6	C72	MT Power Infeed
ZB3BPNY	C73	MT Power Infeed
ZB3BPNY30	C73	MT Power Infeed
ZB3PJ12	C75	MT Modular Jumper
ZB3PTR24	C71	MT Pass-Thru Powerkit
ZB3PTR30	C71	MT Pass-Thru Powerkit
ZB3PTR36	C71	MT Pass-Thru Powerkit
ZB3PTR42	C71	MT Pass-Thru Powerkit
ZB3PTR48	C71	MT Pass-Thru Powerkit
ZB3PW24	C70	MT Powerkit
ZB3PW30	C70	MT Powerkit
ZB3PW36	C70	MT Powerkit
ZB3PW42	C70	MT Powerkit
ZB3PW48	C70	MT Powerkit
ZB3R1IG	C78	MT 15-Amp Receptacle
ZB3R1IGH	B81, C79	20-Amp Receptacle
ZB3R1SG	C78	MT 15-Amp Receptacle
ZB3R1SGH	B81, C79	20-Amp Receptacle
ZB3R2IG	C78	MT 15-Amp Receptacle
ZB3R2IGH	B81, C79	20-Amp Receptacle
ZB3R2SG	C78	MT 15-Amp Receptacle
ZB3R2SGH	B81, C79	20-Amp Receptacle
ZB3R3IG	C78	MT 15-Amp Receptacle
ZB3R3IGH	B81, C79	20-Amp Receptacle
ZB3R3SG	C78	MT 15-Amp Receptacle
ZB3R3SGH	B81, C79	20-Amp Receptacle
ZBBWOM	C222	MT WS Off-Mod Attachment Brkt
ZBC24	C81	MT Plain Base Cover
ZBC30	C81	MT Plain Base Cover
ZBC36	C81	MT Plain Base Cover
ZBC42	C81	MT Plain Base Cover
ZBC48	C81	MT Plain Base Cover
ZBES	C138, C187, D43	Side Support Brackets

Style Number	Page	Description
ZBFOME20	C50	MT Frame Attach Brkt
ZBFOME45	C50	MT Frame Attach Brkt
ZBFOME65	C50	MT Frame Attach Brkt
ZBFOME86	C50	MT Frame Attach Brkt
ZBFOMW20	C50	MT Frame Attach Brkt
ZBFOMW45	C50	MT Frame Attach Brkt
ZBFOMW65	C50	MT Frame Attach Brkt
ZBFOMW86	C50	MT Frame Attach Brkt
ZBJ243060L	C131	MT Bubble Jetty Wksf
ZBJ243060R	C131	MT Bubble Jetty Wksf
ZBJ303066L	C131	MT Bubble Jetty Wksf
ZBJ303066R	C131	MT Bubble Jetty Wksf
ZBTP	C139, C188, D43	Off-Module Tie Plate
ZBUTTRESSL	C67	MT Buttress
ZBUTTRESSR	C67	MT Buttress
ZBV2430L	C129	MT Bubble Visitor Wksf
ZBV2430R	C129	MT Bubble Visitor Wksf
ZBV3030L	C129	MT Bubble Visitor Wksf
ZBV3030R	C129	MT Bubble Visitor Wksf
ZBWOM	C139, C188, D43	Off-Module Wksf Bracket
ZCAL	C138, D42	Adj-Height Cantilever
ZCAR	C138, D42	Adj-Height Cantilever
ZCB	C137, C186, D42	Cantilever
ZCC	C82	MT Cable Carrier
ZCC24R24R	C134	MT Cor Countertop
ZCC24R24S	C135	MT Cor Countertop
ZCC24R30R	C134	MT Cor Countertop
ZCC24R30S	C135	MT Cor Countertop
ZCC24R36R	C134	MT Cor Countertop
ZCC24R36S	C135	MT Cor Countertop
ZCC24R42R	C134	MT Cor Countertop
ZCC24R42S	C135	MT Cor Countertop
ZCC24R48R	C134	MT Cor Countertop
ZCC24R48S	C135	MT Cor Countertop
ZCC24S24R	C135	MT Cor Countertop
ZCC24S24S	C134	MT Cor Countertop
ZCC24S30R	C135	MT Cor Countertop
ZCC24S30S	C134	MT Cor Countertop
ZCC24S36R	C135	MT Cor Countertop
ZCC24S36S	C134	MT Cor Countertop
ZCC24S42R	C135	MT Cor Countertop
ZCC24S42S	C134	MT Cor Countertop
ZCC24S48R	C135	MT Cor Countertop
ZCC24S48S	C134	MT Cor Countertop
ZCC30R24R	C134	MT Cor Countertop
ZCC30R24S	C135	MT Cor Countertop
ZCC30R30R	C134	MT Cor Countertop
ZCC30R30S	C135	MT Cor Countertop
ZCC30R36R	C134	MT Cor Countertop
ZCC30R36S	C135	MT Cor Countertop
ZCC30R42R	C134	MT Cor Countertop
ZCC30R42S	C135	MT Cor Countertop
ZCC30R48R	C134	MT Cor Countertop
ZCC30R48S	C135	MT Cor Countertop

Style Number	Page	Description	Style Number	Page	Description
ZCC30S24R	C135	MT Cor Countertop	ZCC48R36S	C135	MT Cor Countertop
ZCC30S24S	C134	MT Cor Countertop	ZCC48R42R	C134	MT Cor Countertop
ZCC30S30R	C135	MT Cor Countertop	ZCC48R42S	C135	MT Cor Countertop
ZCC30S30S	C134	MT Cor Countertop	ZCC48R48R	C134	MT Cor Countertop
ZCC30S36R	C135	MT Cor Countertop	ZCC48R48S	C135	MT Cor Countertop
ZCC30S36S	C134	MT Cor Countertop	ZCC48S24R	C135	MT Cor Countertop
ZCC30S42R	C135	MT Cor Countertop	ZCC48S24S	C134	MT Cor Countertop
ZCC30S42S	C134	MT Cor Countertop	ZCC48S30R	C135	MT Cor Countertop
ZCC30S48R	C135	MT Cor Countertop	ZCC48S30S	C134	MT Cor Countertop
ZCC30S48S	C134	MT Cor Countertop	ZCC48S36R	C135	MT Cor Countertop
ZCC36R24R	C134	MT Cor Countertop	ZCC48S36S	C134	MT Cor Countertop
ZCC36R24S	C135	MT Cor Countertop	ZCC48S42R	C135	MT Cor Countertop
ZCC36R30R	C134	MT Cor Countertop	ZCC48S42S	C134	MT Cor Countertop
ZCC36R30S	C135	MT Cor Countertop	ZCC48S48R	C135	MT Cor Countertop
ZCC36R36R	C134	MT Cor Countertop	ZCC48S48S	C134	MT Cor Countertop
ZCC36R36S	C135	MT Cor Countertop	ZCEL	C138, C188, D42	End-of-Run Cantilever
ZCC36R42R	C134	MT Cor Countertop	ZCER	C138, C188, D42	End-of-Run Cantilever
ZCC36R42S	C135	MT Cor Countertop	ZCHIBOXB	C76	MT Chicago Junct Box
ZCC36R48R	C134	MT Cor Countertop	ZCHIBOXB30	C76	MT Chicago Junct Box
ZCC36R48S	C135	MT Cor Countertop	ZCKBC42	C140	MT Adj-Hgt Bi-Level Cor Wksf
ZCC36S24R	C135	MT Cor Countertop	ZCKBC48	C140	MT Adj-Hgt Bi-Level Cor Wksf
ZCC36S24S	C134	MT Cor Countertop	ZCKBS42	C140	MT Adj-Hgt Bi-Level Str Wksf
ZCC36S30R	C135	MT Cor Countertop	ZCKBS48	C140	MT Adj-Hgt Bi-Level Str Wksf
ZCC36S30S	C134	MT Cor Countertop	ZCKDC42	C140	MT Adj-Hgt Dual Cor Wksf
ZCC36S36R	C135	MT Cor Countertop	ZCKDC48	C140	MT Adj-Hgt Dual Cor Wksf
ZCC36S36S	C134	MT Cor Countertop	ZCKDS42	C140	MT Adj-Hgt Dual Str Wksf
ZCC36S42R	C135	MT Cor Countertop	ZCKDS48	C140	MT Adj-Hgt Dual Str Wksf
ZCC36S42S	C134	MT Cor Countertop	ZCKEL24	C141	MT Adj-Hgt Ext Wksf
ZCC36S48R	C135	MT Cor Countertop	ZCKEL36	C141	MT Adj-Hgt Ext Wksf
ZCC36S48S	C134	MT Cor Countertop	ZCKER24	C141	MT Adj-Hgt Ext Wksf
ZCC42R24R	C134	MT Cor Countertop	ZCKER36	C141	MT Adj-Hgt Ext Wksf
ZCC42R24S	C135	MT Cor Countertop	ZCKSC42	C140	MT Adj-Hgt Cor Wksf
ZCC42R30R	C134	MT Cor Countertop	ZCKSC48	C140	MT Adj-Hgt Cor Wksf
ZCC42R30S	C135	MT Cor Countertop	ZCKSS42	C140	MT Adj-Hgt Str Wksf
ZCC42R36R	C134	MT Cor Countertop	ZCKSS48	C140	MT Adj-Hgt Str Wksf
ZCC42R36S	C135	MT Cor Countertop	ZCPCM	C85	MT Consol Pt Cbl Mgr
ZCC42R42R	C134	MT Cor Countertop	ZCPK	C84	MT Consol Point Kit
ZCC42R42S	C135	MT Cor Countertop	ZCPMB	C84	MT Consol Point Brkt
ZCC42R48R	C134	MT Cor Countertop	ZCPSE30	C120	MT E Consol Pt Lock Dr Tile
ZCC42R48S	C135	MT Cor Countertop	ZCPSE36	C120	MT E Consol Pt Lock Dr Tile
ZCC42S24R	C135	MT Cor Countertop	ZCPSE42	C120	MT E Consol Pt Lock Dr Tile
ZCC42S24S	C134	MT Cor Countertop	ZCPSE48	C120	MT E Consol Pt Lock Dr Tile
ZCC42S30R	C135	MT Cor Countertop	ZCSB	C137, C186, D42	Shared Cantilever
ZCC42S30S	C134	MT Cor Countertop	ZCT24244242	C125	MT Corner Wksf
ZCC42S36R	C135	MT Cor Countertop	ZCT24244848	C125	MT Corner Wksf
ZCC42S36S	C134	MT Cor Countertop	ZCT24244854	C127	MT Ext Corner Wksf
ZCC42S42R	C135	MT Cor Countertop	ZCT24244860	C127	MT Ext Corner Wksf
ZCC42S42S	C134	MT Cor Countertop	ZCT24244866	C127	MT Ext Corner Wksf
ZCC42S48R	C135	MT Cor Countertop	ZCT24244872	C127	MT Ext Corner Wksf
ZCC42S48S	C134	MT Cor Countertop	ZCT24244878	C127	MT Ext Corner Wksf
ZCC48R24R	C134	MT Cor Countertop	ZCT24245448	C126	MT Ext Corner Wksf
ZCC48R24S	C135	MT Cor Countertop	ZCT24246048	C126	MT Ext Corner Wksf
ZCC48R30R	C134	MT Cor Countertop	ZCT24246648	C126	MT Ext Corner Wksf
ZCC48R30S	C135	MT Cor Countertop	ZCT24247248	C126	MT Ext Corner Wksf
ZCC48R36R	C134	MT Cor Countertop	ZCT24247848	C126	MT Ext Corner Wksf

Style Number Index, continued

Style Number	Page	Description
ZCT24304848	C125	MT Corner Wksf
ZCT24304854	C127	MT Ext Corner Wksf
ZCT24304860	C127	MT Ext Corner Wksf
ZCT24304866	C127	MT Ext Corner Wksf
ZCT24304872	C127	MT Ext Corner Wksf
ZCT24304878	C127	MT Ext Corner Wksf
ZCT24305448	C126	MT Ext Corner Wksf
ZCT24306048	C126	MT Ext Corner Wksf
ZCT24306648	C126	MT Ext Corner Wksf
ZCT24307248	C126	MT Ext Corner Wksf
ZCT24307848	C126	MT Ext Corner Wksf
ZCT30244848	C125	MT Corner Wksf
ZCT30244854	C127	MT Ext Corner Wksf
ZCT30244860	C127	MT Ext Corner Wksf
ZCT30244866	C127	MT Ext Corner Wksf
ZCT30244872	C127	MT Ext Corner Wksf
ZCT30244878	C127	MT Ext Corner Wksf
ZCT30245448	C126	MT Ext Corner Wksf
ZCT30246048	C126	MT Ext Corner Wksf
ZCT30246648	C126	MT Ext Corner Wksf
ZCT30247248	C126	MT Ext Corner Wksf
ZCT30247848	C126	MT Ext Corner Wksf
ZCT30304848	C125	MT Corner Wksf
ZCT30304854	C127	MT Ext Corner Wksf
ZCT30304860	C127	MT Ext Corner Wksf
ZCT30304866	C127	MT Ext Corner Wksf
ZCT30304872	C127	MT Ext Corner Wksf
ZCT30304878	C127	MT Ext Corner Wksf
ZCT30305448	C126	MT Ext Corner Wksf
ZCT30306048	C126	MT Ext Corner Wksf
ZCT30306648	C126	MT Ext Corner Wksf
ZCT30307248	C126	MT Ext Corner Wksf
ZCT30307848	C126	MT Ext Corner Wksf
ZCV24304860	C128	MT Ext Corner Cove Wksf
ZCV24304866	C128	MT Ext Corner Cove Wksf
ZCV24304872	C128	MT Ext Corner Cove Wksf
ZCV24304878	C128	MT Ext Corner Cove Wksf
ZCV30246048	C128	MT Ext Corner Cove Wksf
ZCV30246648	C128	MT Ext Corner Cove Wksf
ZCV30247248	C128	MT Ext Corner Cove Wksf
ZCV30247848	C128	MT Ext Corner Cove Wksf
ZD3086LH	C52	MT Door
ZD3086RH	C52	MT Door
ZD3686LH	C52	MT Door
ZD3686RH	C52	MT Door
ZD4286LH	C52	MT Door
ZD4286RH	C52	MT Door
ZD4886	C52	MT Door
ZDDL	C52	MT Door Lever Set
ZDF3086LH	C51	MT Door Frame
ZDF3086RH	C51	MT Door Frame
ZDF3686LH	C51	MT Door Frame
ZDF3686RH	C51	MT Door Frame
ZDF4286LH	C51	MT Door Frame
ZDF4286RH	C51	MT Door Frame

Style Number	Page	Description
ZDF4886	C51	MT Door Frame
ZDHC24	C83	MT Desk-Hgt Cavity
ZDHC30	C83	MT Desk-Hgt Cavity
ZDHC36	C83	MT Desk-Hgt Cavity
ZDHC42	C83	MT Desk-Hgt Cavity
ZDHC48	C83	MT Desk-Hgt Cavity
ZDL	C52	MT Door Lever Set
ZE91903	C187	MT WS Flush-Mt Brkt
ZEBB24W	C222	MT WS Ovhd Strg Cab
ZEBB30W	C222	MT WS Ovhd Strg Cab
ZEBB36W	C222	MT WS Ovhd Strg Cab
ZEBB42W	C222	MT WS Ovhd Strg Cab
ZEBB48W	C222	MT WS Ovhd Strg Cab
ZEBB60W	C222	MT WS Ovhd Strg Cab
ZEBC3045W	C229	MT WS Bookcase
ZEBC3065W	C229	MT WS Bookcase
ZEBP4210W	C204	MT WS Back Panel
ZEBP4227W	C204	MT WS Back Panel
ZEBP4810W	C204	MT WS Back Panel
ZEBP4827W	C204	MT WS Back Panel
ZEBP6010W	C204	MT WS Back Panel
ZEBP6027W	C204	MT WS Back Panel
ZEBP6610W	C204	MT WS Back Panel
ZEBP6627W	C204	MT WS Back Panel
ZEBP7210W	C204	MT WS Back Panel
ZEBP7227W	C204	MT WS Back Panel
ZEBP9010W	C204	MT WS Back Panel
ZEBP9027W	C204	MT WS Back Panel
ZEBPB4210W	C204	MT WS Back Panel
ZEBPB4227W	C204	MT WS Back Panel
ZEBPB4810W	C204	MT WS Back Panel
ZEBPB4827W	C204	MT WS Back Panel
ZEBS2442W	C195	MT WS Bridge Shell
ZEBS2448W	C195	MT WS Bridge Shell
ZEBS24W	C220	MT WS Ovhd Strg Shlf
ZEBS3042W	C195	MT WS Bridge Shell
ZEBS3048W	C195	MT WS Bridge Shell
ZEBS30W	C220	MT WS Ovhd Strg Shlf
ZEBS36W	C220	MT WS Ovhd Strg Shlf
ZEBS42W	C220	MT WS Ovhd Strg Shlf
ZEBS48W	C220	MT WS Ovhd Strg Shlf
ZEBS60W	C220	MT WS Ovhd Strg Shlf
ZECDC42	C142	MT Adj-Hgt Dual Cor Wksf
ZECDC48	C142	MT Adj-Hgt Dual Cor Wksf
ZECDS42	C142	MT Adj-Hgt Dual Str Wksf
ZECDS48	C142	MT Adj-Hgt Dual Str Wksf
ZECP15W	C203	MT WS Center-Sprnt Pnl
ZECS2442W	C199	MT WS Wksf Shell
ZECS2442W10	C199	MT WS Wksf Shell
ZECS2448W	C199	MT WS Wksf Shell
ZECS2448W10	C199	MT WS Wksf Shell
ZECS2472W	C197	MT WS Cred Shell
ZECS2490W	C197	MT WS Cred Shell
ZECS3042W	C199	MT WS Wksf Shell
ZECS3042W10	C199	MT WS Wksf Shell

Style Number	Page	Description	Style Number	Page	Description
ZECS3048W	C199	MT WS Wksf Shell	ZEP2427FRW	C201	MT WS Free End Pnl
ZECS3048W10	C199	MT WS Wksf Shell	ZEP24LH	C136, D44	Standard End Panel
ZECS3090W	C197	MT WS Cred Shell	ZEP24LHOM	C137, D44	Off-Module End Panel
ZECSC42	C142	MT Adj-Hgt Cor Wksf	ZEP24RH	C136, D44	Standard End Panel
ZECSC48	C142	MT Adj-Hgt Cor Wksf	ZEP24RHOM	C137, D44	Off-Module End Panel
ZECSS42	C142	MT Adj-Hgt Str Wksf	ZEP3010FLW	C200	MT WS Free End Pnl
ZECSS48	C142	MT Adj-Hgt Str Wksf	ZEP3010FRW	C200	MT WS Free End Pnl
ZECT	C88	MT End Cap	ZEP3027FLW	C201	MT WS Free End Pnl
ZEFC2442W	C198	MT WS Cnr Wksf Shell	ZEP3027FRW	C201	MT WS Free End Pnl
ZEFC2442W10	C198	MT WS Cnr Wksf Shell	ZEP3027RLW	C201	MT WS Free End Pnl
ZEFC2448W	C198	MT WS Cnr Wksf Shell	ZEP3027RRW	C201	MT WS Free End Pnl
ZEFC2448W10	C198	MT WS Cnr Wksf Shell	ZEP30LH	C136, D44	Standard End Panel
ZEFC3042W	C198	MT WS Cnr Wksf Shell	ZEP30LHOM	C137, D44	Off-Module End Panel
ZEFC3042W10	C198	MT WS Cnr Wksf Shell	ZEP30RH	C136, D44	Standard End Panel
ZEFC3048W	C198	MT WS Cnr Wksf Shell	ZEP30RHOM	C137, D44	Off-Module End Panel
ZEFC3048W10	C198	MT WS Cnr Wksf Shell	ZEP3610FLW	C200	MT WS Free End Pnl
ZEPF510FLW	C202	MT WS Filler Pnl	ZEP3610FRW	C200	MT WS Free End Pnl
ZEPF510FRW	C202	MT WS Filler Pnl	ZEP3627FLW	C201	MT WS Free End Pnl
ZEPF527FLW	C202	MT WS Filler Pnl	ZEP3627FRW	C201	MT WS Free End Pnl
ZEPF527FRW	C202	MT WS Filler Pnl	ZEP3627RLW	C201	MT WS Free End Pnl
ZEPF527RLW	C202	MT WS Filler Pnl	ZEP3627RRW	C201	MT WS Free End Pnl
ZEPF527RRW	C202	MT WS Filler Pnl	ZEPBBF19W	C207	MT WS Pedestal
ZEPS3060W	C191	MT WS Free Desk Shell	ZEPBBF23W	C207	MT WS Pedestal
ZEPS3066W	C191	MT WS Free Desk Shell	ZEPBBF24W	C207	MT WS Pedestal
ZEPS3072W	C191	MT WS Free Desk Shell	ZEPBBF29W	C207	MT WS Pedestal
ZEPS3672W	C191	MT WS Free Desk Shell	ZEPDDW	C207	MT WS Pedestal
ZEL2436W	C213	MT WS Free Lat File	ZEPFF19W	C207	MT WS Pedestal
ZEL2W	C213	MT WS Free Lat File	ZEPFF23W	C207	MT WS Pedestal
ZEL4W	C213	MT WS Free Lat File	ZEPFF24W	C207	MT WS Pedestal
ZEMPW	C215	MT WS Mobile Ped	ZEPFF29W	C207	MT WS Pedestal
ZEORG1224W	C221	MT WS Organizer Shlf	ZEPLF1930W	C207	MT WS Pedestal
ZEORG1230W	C221	MT WS Organizer Shlf	ZEPLF1936W	C207	MT WS Pedestal
ZEORG1236W	C221	MT WS Organizer Shlf	ZEPOPW	C207	MT WS Pedestal
ZEORG1242W	C221	MT WS Organizer Shlf	ZEPW24LH	C185	MT WS End Panel
ZEORG1248W	C221	MT WS Organizer Shlf	ZEPW24LHOM	C185	MT WS End Panel
ZEORG1260W	C221	MT WS Organizer Shlf	ZEPW24RH	C185	MT WS End Panel
ZEORG1266W	C221	MT WS Organizer Shlf	ZEPW24RHOM	C185	MT WS End Panel
ZEORG1272W	C221	MT WS Organizer Shlf	ZEPW30LH	C185	MT WS End Panel
ZEORG1524W	C221	MT WS Organizer Shlf	ZEPW30LHOM	C185	MT WS End Panel
ZEORG1530W	C221	MT WS Organizer Shlf	ZEPW30RH	C185	MT WS End Panel
ZEORG1536W	C221	MT WS Organizer Shlf	ZEPW30RHOM	C185	MT WS End Panel
ZEORG1542W	C221	MT WS Organizer Shlf	ZERS2448W	C193	MT WS Return Shell
ZEORG1548W	C221	MT WS Organizer Shlf	ZERS2460W	C193	MT WS Return Shell
ZEORG1560W	C221	MT WS Organizer Shlf	ZERS3048W	C193	MT WS Return Shell
ZEORG1566W	C221	MT WS Organizer Shlf	ZERS3060W	C193	MT WS Return Shell
ZEORG1572W	C221	MT WS Organizer Shlf	ZESM60W	C223	MT WS Service Module
ZEP1510FLW	C200	MT WS Free End Pnl	ZESM66W	C223	MT WS Service Module
ZEP1510FRW	C200	MT WS Free End Pnl	ZESM72W	C223	MT WS Service Module
ZEP1527FLW	C201	MT WS Free End Pnl	ZESM90W	C223	MT WS Service Module
ZEP1527FRW	C201	MT WS Free End Pnl	ZESMCV	C219	MT WS Stdg Ht Mbl Cab
ZEP1527RLW	C201	MT WS Free End Pnl	ZESPW	C216	MT WS Smart Mbl Ped
ZEP1527RRW	C201	MT WS Free End Pnl	ZESPWS	C217	MT WS Smart Mbl Ped
ZEP2410FLW	C200	MT WS Free End Pnl	ZET20	C66	MT Vertical End Trim
ZEP2410FRW	C200	MT WS Free End Pnl	ZET20W	C65, C231	MT Wd Vert End Trim
ZEP2427FLW	C201	MT WS Free End Pnl	ZET22	C94	MT End Trim

Style Number Index, continued

Style Number	Page	Description
ZET40	C66	MT Vertical End Trim
ZET40W	C65	MT Wd Vert End Trim
ZET42	C94	MT End Trim
ZET45	C66	MT Vertical End Trim
ZET45W	C65, C231	MT Wd Vert End Trim
ZET47	C94	MT End Trim
ZET65	C66	MT Vertical End Trim
ZET65W	C65, C231	MT Wd Vert End Trim
ZET67	C94	MT End Trim
ZET86	C66	MT Vertical End Trim
ZET86W	C65, C231	MT Wd Vert End Trim
ZET88	C94	MT End Trim
ZETB60	C224	MT WS Serv Mdl Tkbd
ZETB66	C224	MT WS Serv Mdl Tkbd
ZETB72	C224	MT WS Serv Mdl Tkbd
ZETB90	C224	MT WS Serv Mdl Tkbd
ZETP3015W	C186	MT WS T-Shape Pnl
ZETP3060W	C176	MT WS T-Shape Pnl
ZETP3066W	C176	MT WS T-Shape Pnl
ZETP3072W	C176	MT WS T-Shape Pnl
ZETP3090W	C176	MT WS T-Shape Pnl
ZETP3615W	C186	MT WS T-Shape Pnl
ZETP3660W	C176	MT WS T-Shape Pnl
ZETP3666W	C176	MT WS T-Shape Pnl
ZETP3672W	C176	MT WS T-Shape Pnl
ZETP3690W	C176	MT WS T-Shape Pnl
ZETPL3066W	C176	MT WS T-Shape Pnl
ZETPL3072W	C176	MT WS T-Shape Pnl
ZETPL3666W	C176	MT WS T-Shape Pnl
ZETPL3672W	C176	MT WS T-Shape Pnl
ZETPR3066W	C176	MT WS T-Shape Pnl
ZETPR3072W	C176	MT WS T-Shape Pnl
ZETPR3666W	C176	MT WS T-Shape Pnl
ZETPR3672W	C176	MT WS T-Shape Pnl
ZEVC2F2D	C227	MT WS Vert Cab
ZEVC3	C227	MT WS Vert Cab
ZEVC3LWR	C227	MT WS Vert Cab
ZEVC3RWL	C227	MT WS Vert Cab
ZEVCWARD	C227	MT WS Vert Cab
ZEW1VCW	C228	MT WS Worksurface
ZEW2424W_	C167	MT WS Straight Wksf
ZEW2430W_	C167	MT WS Straight Wksf
ZEW2436W_	C167	MT WS Straight Wksf
ZEW2442W_	C167	MT WS Straight Wksf
ZEW2448W_	C167	MT WS Straight Wksf
ZEW2454W_	C167	MT WS Straight Wksf
ZEW2460W_	C167	MT WS Straight Wksf
ZEW2466W_	C167	MT WS Straight Wksf
ZEW2472W_	C167	MT WS Straight Wksf
ZEW2490W_	C167	MT WS Straight Wksf
ZEW2VCW	C228	MT WS Worksurface
ZEW3024W_	C167	MT WS Straight Wksf
ZEW3030W_	C167	MT WS Straight Wksf
ZEW3036W_	C167	MT WS Straight Wksf
ZEW3042W_	C167	MT WS Straight Wksf

Style Number	Page	Description
ZEW3048W_	C167	MT WS Straight Wksf
ZEW3054W_	C167	MT WS Straight Wksf
ZEW3060W_	C167	MT WS Straight Wksf
ZEW3066W_	C167	MT WS Straight Wksf
ZEW3072W_	C167	MT WS Straight Wksf
ZEW3090W_	C167	MT WS Straight Wksf
ZEW3VCW	C228	MT WS Worksurface
ZEWB3060W_	C175	MT WS Bullet Top Wksf
ZEWB3066W_	C175	MT WS Bullet Top Wksf
ZEWB3072W_	C175	MT WS Bullet Top Wksf
ZEWB3090W_	C175	MT WS Bullet Top Wksf
ZEWB3660W_	C175	MT WS Bullet Top Wksf
ZEWB3666W_	C175	MT WS Bullet Top Wksf
ZEWB3672W_	C175	MT WS Bullet Top Wksf
ZEWB3690W_	C175	MT WS Bullet Top Wksf
ZEWC2442W_	C170	MT WS Corner Wksf
ZEWC2448W_	C170	MT WS Corner Wksf
ZEWC3042W_	C170	MT WS Corner Wksf
ZEWC3048W_	C170	MT WS Corner Wksf
ZEWCS2442W_	C171	MT WS Crrrstone Wksf
ZEWCS2448W_	C171	MT WS Crrrstone Wksf
ZEWCS3042W_	C171	MT WS Crrrstone Wksf
ZEWCS3048W_	C171	MT WS Crrrstone Wksf
ZEWPL3066W_	C179	MT WS P-Top Wksf
ZEWPL3072W_	C179	MT WS P-Top Wksf
ZEWPL3666W_	C179	MT WS P-Top Wksf
ZEWPL3672W_	C179	MT WS P-Top Wksf
ZEWPR3066W_	C179	MT WS P-Top Wksf
ZEWPR3072W_	C179	MT WS P-Top Wksf
ZEWPR3666W_	C179	MT WS P-Top Wksf
ZEWPR3672W_	C179	MT WS P-Top Wksf
ZEWSCL24W_	C183	MT WS Scoop Wksf
ZEWSCL24W_	C183	MT WS Scoop Wksf
ZEWSL24W_	C181	MT WS Sock Top Wksf
ZEWSP3651W_	C172	MT WS Spanner Wksf
ZEWSP3663W_	C172	MT WS Spanner Wksf
ZEWSR24W_	C181	MT WS Sock Top Wksf
ZEWTC30W_	C184	MT WS Crv-Frnt Trans Wksf
ZEWTC36W_	C184	MT WS Crv-Frnt Trans Wksf
ZEWTC42W_	C184	MT WS Crv-Frnt Trans Wksf
ZEWTC48W_	C184	MT WS Crv-Frnt Trans Wksf
ZEWTC60W_	C184	MT WS Crv-Frnt Trans Wksf
ZEWTL3060W_	C169	MT WS Transition Wksf
ZEWTL3066W_	C169	MT WS Transition Wksf
ZEWTL3072W_	C169	MT WS Transition Wksf
ZEWTL3090W_	C169	MT WS Transition Wksf
ZEWTR3060W_	C169	MT WS Transition Wksf
ZEWTR3066W_	C169	MT WS Transition Wksf
ZEWTR3072W_	C169	MT WS Transition Wksf
ZEWTR3090W_	C169	MT WS Transition Wksf
ZEWTTW	C189	MT WS Tether Table
ZFC20CH	C87	MT Lay-In Track & Cvr
ZFC24	C86	MT Lay-In Track & Cvr
ZFC24CH1	C87	MT Lay-In Track & Cvr
ZFC24CH2	C87	MT Lay-In Track & Cvr

Style Number	Page	Description	Style Number	Page	Description
ZFC30	C86	MT Lay-In Track & Cvr	ZFOM2486	C48	MT EOM Four-High Frame
ZFC30CH1	C87	MT Lay-In Track & Cvr	ZFOM2486DC	C48	MT EOM Four-High Frame
ZFC30CH2	C87	MT Lay-In Track & Cvr	ZFOM3020	C49	MT EOM Single Frame
ZFC36	C86	MT Lay-In Track & Cvr	ZFOM3045	C46	MT EOM Two-High Frame
ZFC36CH1	C87	MT Lay-In Track & Cvr	ZFOM3045DC	C46	MT EOM Two-High Frame
ZFC36CH2	C87	MT Lay-In Track & Cvr	ZFOM3065	C47	MT EOM Three-High Frame
ZFC40CH	C87	MT Lay-In Track & Cvr	ZFOM3065DC	C47	MT EOM Three-High Frame
ZFC42	C86	MT Lay-In Track & Cvr	ZFOM3086	C48	MT EOM Four-High Frame
ZFC42CH1	C87	MT Lay-In Track & Cvr	ZFOM3086DC	C48	MT EOM Four-High Frame
ZFC42CH2	C87	MT Lay-In Track & Cvr	ZFOM3620	C49	MT EOM Single Frame
ZFC48	C86	MT Lay-In Track & Cvr	ZFOM3645	C46	MT EOM Two-High Frame
ZFC48CH1	C87	MT Lay-In Track & Cvr	ZFOM3645DC	C46	MT EOM Two-High Frame
ZFC48CH2	C87	MT Lay-In Track & Cvr	ZFOM3665	C47	MT EOM Three-High Frame
ZFE2420	C45	MT E Single Frame	ZFOM3665DC	C47	MT EOM Three-High Frame
ZFE2445	C42	MT E Two-High Frame	ZFOM3686	C48	MT EOM Four-High Frame
ZFE2445DC	C42	MT E Two-High Frame	ZFOM3686DC	C48	MT EOM Four-High Frame
ZFE2465	C43	MT E Three-High Frame	ZFOM4220	C49	MT EOM Single Frame
ZFE2465DC	C43	MT E Three-High Frame	ZFOM4245	C46	MT EOM Two-High Frame
ZFE2486	C44	MT E Four-High Frame	ZFOM4245DC	C46	MT EOM Two-High Frame
ZFE2486DC	C44	MT E Four-High Frame	ZFOM4265	C47	MT EOM Three-High Frame
ZFE3020	C45	MT E Single Frame	ZFOM4265DC	C47	MT EOM Three-High Frame
ZFE3045	C42	MT E Two-High Frame	ZFOM4286	C48	MT EOM Four-High Frame
ZFE3045DC	C42	MT E Two-High Frame	ZFOM4286DC	C48	MT EOM Four-High Frame
ZFE3065	C43	MT E Three-High Frame	ZFOM4820	C49	MT EOM Single Frame
ZFE3065DC	C43	MT E Three-High Frame	ZFOM4845	C46	MT EOM Two-High Frame
ZFE3086	C44	MT E Four-High Frame	ZFOM4845DC	C46	MT EOM Two-High Frame
ZFE3086DC	C44	MT E Four-High Frame	ZFOM4865	C47	MT EOM Three-High Frame
ZFE3620	C45	MT E Single Frame	ZFOM4865DC	C47	MT EOM Three-High Frame
ZFE3645	C42	MT E Two-High Frame	ZFOM4886	C48	MT EOM Four-High Frame
ZFE3645DC	C42	MT E Two-High Frame	ZFOM4886DC	C48	MT EOM Four-High Frame
ZFE3665	C43	MT E Three-High Frame	ZFP	C81	MT Filler Plate
ZFE3665DC	C43	MT E Three-High Frame	ZFS51	C132	MT Fan Spanner Wksf
ZFE3686	C44	MT E Four-High Frame	ZFS63	C132	MT Fan Spanner Wksf
ZFE3686DC	C44	MT E Four-High Frame	ZFTE	C121	MT E Tile Remov Tool
ZFE4220	C45	MT E Single Frame	ZJ24304866R	C130	MT Jetty Wksf
ZFE4245	C42	MT E Two-High Frame	ZJ24304878R	C130	MT Jetty Wksf
ZFE4245DC	C42	MT E Two-High Frame	ZJ30246648L	C130	MT Jetty Wksf
ZFE4265	C43	MT E Three-High Frame	ZJ30247848L	C130	MT Jetty Wksf
ZFE4265DC	C43	MT E Three-High Frame	ZJ30304866R	C130	MT Jetty Wksf
ZFE4286	C44	MT E Four-High Frame	ZJ30304878R	C130	MT Jetty Wksf
ZFE4286DC	C44	MT E Four-High Frame	ZJ30306648L	C130	MT Jetty Wksf
ZFE4820	C45	MT E Single Frame	ZJ30307848L	C130	MT Jetty Wksf
ZFE4845	C42	MT E Two-High Frame	ZJI44	C63	MT I-Junction
ZFE4845DC	C42	MT E Two-High Frame	ZJI44CT	C92	MT Frame Junction Kit
ZFE4865	C43	MT E Three-High Frame	ZJI44W	C63	MT I-Junction
ZFE4865DC	C43	MT E Three-High Frame	ZJI46	C63	MT I-Junction
ZFE4886	C44	MT E Four-High Frame	ZJI46CT	C92	MT Frame Junction Kit
ZFE4886DC	C44	MT E Four-High Frame	ZJI46W	C63	MT I-Junction
ZFENCELC	C68	MT Fence Connector	ZJI48	C63	MT I-Junction
ZFENCERC	C68	MT Fence Connector	ZJI48CT	C92	MT Frame Junction Kit
ZFOM2420	C49	MT EOM Single Frame	ZJI48W	C63	MT I-Junction
ZFOM2445	C46	MT EOM Two-High Frame	ZJI66	C63	MT I-Junction
ZFOM2445DC	C46	MT EOM Two-High Frame	ZJI66CT	C92	MT Frame Junction Kit
ZFOM2465	C47	MT EOM Three-High Frame	ZJI66W	C63	MT I-Junction
ZFOM2465DC	C47	MT EOM Three-High Frame	ZJI68	C63	MT I-Junction

Style Number Index, continued

Style Number	Page	Description
ZJI68CT	C92	MT Frame Junction Kit
ZJI68W	C63	MT I-Junction
ZJI88	C63	MT I-Junction
ZJI88CT	C92	MT Frame Junction Kit
ZJI88W	C63	MT I-Junction
ZJL44C	C54	MT Chamf L-Junct
ZJL44R	C54	MT Radius L-Junct
ZJL44S	C53	MT Square L-Junct
ZJL44SCT	C90	MT Frame Junction Kit
ZJL44SCT1	C93	MT Frame Junction Kit
ZJL44SW	C53	MT Square L-Junct
ZJL46C	C54	MT Chamf L-Junct
ZJL46R	C54	MT Radius L-Junct
ZJL46S	C53	MT Square L-Junct
ZJL46SCT	C90	MT Frame Junction Kit
ZJL46SCT1	C93	MT Frame Junction Kit
ZJL46SW	C53	MT Square L-Junct
ZJL48C	C54	MT Chamf L-Junct
ZJL48R	C54	MT Radius L-Junct
ZJL48S	C53	MT Square L-Junct
ZJL48SCT	C90	MT Frame Junction Kit
ZJL48SCT1	C93	MT Frame Junction Kit
ZJL48SW	C53	MT Square L-Junct
ZJL66C	C54	MT Chamf L-Junct
ZJL66R	C54	MT Radius L-Junct
ZJL66S	C53	MT Square L-Junct
ZJL66SCT	C90	MT Frame Junction Kit
ZJL66SCT1	C93	MT Frame Junction Kit
ZJL66SW	C53	MT Square L-Junct
ZJL68C	C54	MT Chamf L-Junct
ZJL68R	C54	MT Radius L-Junct
ZJL68S	C53	MT Square L-Junct
ZJL68SCT	C90	MT Frame Junction Kit
ZJL68SCT1	C93	MT Frame Junction Kit
ZJL68SW	C53	MT Square L-Junct
ZJL88C	C54	MT Chamf L-Junct
ZJL88R	C54	MT Radius L-Junct
ZJL88S	C53	MT Square L-Junct
ZJL88SCT	C90	MT Frame Junction Kit
ZJL88SCT1	C93	MT Frame Junction Kit
ZJL88SW	C53	MT Square L-Junct
ZJT444	C55	MT T-Junction
ZJT444CT	C91	MT Frame Junction Kit
ZJT444CT2	C93	MT Frame Junction Kit
ZJT444W	C55	MT T-Junction
ZJT466	C55	MT T-Junction
ZJT466CT	C91	MT Frame Junction Kit
ZJT466CT2	C93	MT Frame Junction Kit
ZJT466W	C55	MT T-Junction
ZJT468	C56	MT T-Junction
ZJT468W	C56	MT T-Junction
ZJT488	C55	MT T-Junction
ZJT488CT	C91	MT Frame Junction Kit
ZJT488CT2	C93	MT Frame Junction Kit
ZJT488W	C55	MT T-Junction

Style Number	Page	Description
ZJT644	C56	MT T-Junction
ZJT644CT	C91	MT Frame Junction Kit
ZJT644W	C56	MT T-Junction
ZJT664	C56	MT T-Junction
ZJT664W	C56	MT T-Junction
ZJT666	C55	MT T-Junction
ZJT666CT	C91	MT Frame Junction Kit
ZJT666CT2	C93	MT Frame Junction Kit
ZJT666W	C55	MT T-Junction
ZJT688	C55	MT T-Junction
ZJT688CT	C91	MT Frame Junction Kit
ZJT688CT2	C93	MT Frame Junction Kit
ZJT688W	C55	MT T-Junction
ZJT844	C56	MT T-Junction
ZJT844CT	C91	MT Frame Junction Kit
ZJT844W	C56	MT T-Junction
ZJT864	C56	MT T-Junction
ZJT864W	C56	MT T-Junction
ZJT866	C56	MT T-Junction
ZJT866CT	C91	MT Frame Junction Kit
ZJT866W	C56	MT T-Junction
ZJT884	C56	MT T-Junction
ZJT884W	C56	MT T-Junction
ZJT886	C56	MT T-Junction
ZJT886W	C56	MT T-Junction
ZJT888	C55	MT T-Junction
ZJT888CT	C91	MT Frame Junction Kit
ZJT888CT2	C93	MT Frame Junction Kit
ZJT888W	C55	MT T-Junction
ZJV44	C62	MT V-Junction
ZJV46	C62	MT V-Junction
ZJV48	C62	MT V-Junction
ZJV66	C62	MT V-Junction
ZJV68	C62	MT V-Junction
ZJV88	C62	MT V-Junction
ZJX4444	C57	MT X-Junction
ZJX4444CT	C92	MT Frame Junction Kit
ZJX4444CT2	C94	MT Frame Junction Kit
ZJX4444W	C57	MT X-Junction
ZJX4446	C58	MT X-Junction
ZJX4446W	C58	MT X-Junction
ZJX4448	C58	MT X-Junction
ZJX4448W	C58	MT X-Junction
ZJX4466	C58	MT X-Junction
ZJX4466W	C58	MT X-Junction
ZJX4468	C59	MT X-Junction
ZJX4468W	C59	MT X-Junction
ZJX4488	C58	MT X-Junction
ZJX4488W	C58	MT X-Junction
ZJX4646	C58	MT X-Junction
ZJX4646CT	C92	MT Frame Junction Kit
ZJX4646CT2	C94	MT Frame Junction Kit
ZJX4646W	C58	MT X-Junction
ZJX4648	C58	MT X-Junction
ZJX4648W	C58	MT X-Junction

Style Number	Page	Description	Style Number	Page	Description
ZJX4668	C59	MT X-Junction	ZPBCJ48B	C80	MT Powerkit Base Cvr
ZJX4668W	C59	MT X-Junction	ZPEDC24B	C82	MT E Desk-Hgt CavCvr
ZJX4688	C59	MT X-Junction	ZPEDC30B	C82	MT E Desk-Hgt CavCvr
ZJX4688W	C59	MT X-Junction	ZPEDC36B	C82	MT E Desk-Hgt CavCvr
ZJX4848	C58	MT X-Junction	ZPEDC42B	C82	MT E Desk-Hgt CavCvr
ZJX4848CT	C92	MT Frame Junction Kit	ZPEDC48B	C82	MT E Desk-Hgt CavCvr
ZJX4848CT2	C94	MT Frame Junction Kit	ZPP19	C74	MT Pwr & Cable Pole
ZJX4848W	C58	MT X-Junction	ZPP40	C74	MT Pwr & Cable Pole
ZJX4868	C59	MT X-Junction	ZPP61	C74	MT Pwr & Cable Pole
ZJX4868W	C59	MT X-Junction	ZSC24RR	C133	MT Str Countertop
ZJX6664	C57	MT X-Junction	ZSC24RS	C133	MT Str Countertop
ZJX6664W	C57	MT X-Junction	ZSC24SS	C133	MT Str Countertop
ZJX6666	C57	MT X-Junction	ZSC30RR	C133	MT Str Countertop
ZJX6666CT	C92	MT Frame Junction Kit	ZSC30RS	C133	MT Str Countertop
ZJX6666CT2	C94	MT Frame Junction Kit	ZSC30SS	C133	MT Str Countertop
ZJX6666W	C57	MT X-Junction	ZSC36RR	C133	MT Str Countertop
ZJX6668	C58	MT X-Junction	ZSC36RS	C133	MT Str Countertop
ZJX6668W	C58	MT X-Junction	ZSC36SS	C133	MT Str Countertop
ZJX6688	C58	MT X-Junction	ZSC42RR	C133	MT Str Countertop
ZJX6688W	C58	MT X-Junction	ZSC42RS	C133	MT Str Countertop
ZJX6868	C58	MT X-Junction	ZSC42SS	C133	MT Str Countertop
ZJX6868CT	C92	MT Frame Junction Kit	ZSC48RR	C133	MT Str Countertop
ZJX6868CT2	C94	MT Frame Junction Kit	ZSC48RS	C133	MT Str Countertop
ZJX6868W	C58	MT X-Junction	ZSC48SS	C133	MT Str Countertop
ZJX8884	C57	MT X-Junction	ZSC54RR	C133	MT Str Countertop
ZJX8884W	C57	MT X-Junction	ZSC54RS	C133	MT Str Countertop
ZJX8886	C57	MT X-Junction	ZSC54SS	C133	MT Str Countertop
ZJX8886W	C57	MT X-Junction	ZSC60RR	C133	MT Str Countertop
ZJX8888	C57	MT X-Junction	ZSC60RS	C133	MT Str Countertop
ZJX8888CT	C92	MT Frame Junction Kit	ZSC60SS	C133	MT Str Countertop
ZJX8888CT2	C94	MT Frame Junction Kit	ZSC66RR	C133	MT Str Countertop
ZJX8888W	C57	MT X-Junction	ZSC66RS	C133	MT Str Countertop
ZJY444	C60	MT Y-Junction	ZSC66SS	C133	MT Str Countertop
ZJY446	C60	MT Y-Junction	ZSC72RR	C133	MT Str Countertop
ZJY448	C60	MT Y-Junction	ZSC72RS	C133	MT Str Countertop
ZJY466	C60	MT Y-Junction	ZSC72SS	C133	MT Str Countertop
ZJY468	C61	MT Y-Junction	ZSC78RR	C133	MT Str Countertop
ZJY488	C60	MT Y-Junction	ZSC78RS	C133	MT Str Countertop
ZJY664	C60	MT Y-Junction	ZSC78SS	C133	MT Str Countertop
ZJY666	C60	MT Y-Junction	ZSC84RR	C133	MT Str Countertop
ZJY668	C60	MT Y-Junction	ZSC84RS	C133	MT Str Countertop
ZJY688	C60	MT Y-Junction	ZSC84SS	C133	MT Str Countertop
ZJY864	C61	MT Y-Junction	ZSC90RR	C133	MT Str Countertop
ZJY884	C60	MT Y-Junction	ZSC90RS	C133	MT Str Countertop
ZJY886	C60	MT Y-Junction	ZSC90SS	C133	MT Str Countertop
ZJY888	C60	MT Y-Junction	ZSC96RR	C133	MT Str Countertop
ZPBC24B	C80	MT Powerkit Base Cvr	ZSC96RS	C133	MT Str Countertop
ZPBC30B	C80	MT Powerkit Base Cvr	ZSC96SS	C133	MT Str Countertop
ZPBC36B	C80	MT Powerkit Base Cvr	ZSP51	C132	MT Spanner Wksf
ZPBC42B	C80	MT Powerkit Base Cvr	ZSP63	C132	MT Spanner Wksf
ZPBC48B	C80	MT Powerkit Base Cvr	ZST2424	C124	MT Straight Wksf
ZPBCJ24B	C80	MT Powerkit Base Cvr	ZST2430	C124	MT Straight Wksf
ZPBCJ30B	C80	MT Powerkit Base Cvr	ZST2436	C124	MT Straight Wksf
ZPBCJ36B	C80	MT Powerkit Base Cvr	ZST2442	C124	MT Straight Wksf
ZPBCJ42B	C80	MT Powerkit Base Cvr	ZST2448	C124	MT Straight Wksf

Style Number Index, continued

Style Number	Page	Description
ZST2454	C124	MT Straight Wksf
ZST2460	C124	MT Straight Wksf
ZST2466	C124	MT Straight Wksf
ZST2472	C124	MT Straight Wksf
ZST3024	C124	MT Straight Wksf
ZST3030	C124	MT Straight Wksf
ZST3036	C124	MT Straight Wksf
ZST3042	C124	MT Straight Wksf
ZST3048	C124	MT Straight Wksf
ZST3054	C124	MT Straight Wksf
ZST3060	C124	MT Straight Wksf
ZST3066	C124	MT Straight Wksf
ZST3072	C124	MT Straight Wksf
ZSWE2413	C118	MT E Slatwall Tile
ZSWE2420	C118	MT E Slatwall Tile
ZSWE3013	C118	MT E Slatwall Tile
ZSWE3020	C118	MT E Slatwall Tile
ZSWE3613	C118	MT E Slatwall Tile
ZSWE3620	C118	MT E Slatwall Tile
ZSWE4213	C118	MT E Slatwall Tile
ZSWE4220	C118	MT E Slatwall Tile
ZSWE4813	C118	MT E Slatwall Tile
ZSWE4820	C118	MT E Slatwall Tile
ZTAE2413	C110	MT E Tack Acst Tile
ZTAE2420	C110	MT E Tack Acst Tile
ZTAE3013	C110	MT E Tack Acst Tile
ZTAE3020	C110	MT E Tack Acst Tile
ZTAE3613	C110	MT E Tack Acst Tile
ZTAE3620	C110	MT E Tack Acst Tile
ZTAE4213	C110	MT E Tack Acst Tile
ZTAE4220	C110	MT E Tack Acst Tile
ZTAE4813	C110	MT E Tack Acst Tile
ZTAE4820	C110	MT E Tack Acst Tile
ZTC24W	C64, C230	MT Wood Top Cap
ZTC30W	C64, C230	MT Wood Top Cap
ZTC36W	C64, C230	MT Wood Top Cap
ZTC42W	C64, C230	MT Wood Top Cap
ZTC48W	C64, C230	MT Wood Top Cap
ZTCJL3W	C64, C230	MT Wood Top Cap
ZTCJT3W	C64, C230	MT Wood Top Cap
ZTCJX3W	C64, C230	MT Wood Top Cap
ZTFE2420	C83, C113	MT E Non-Tack Tile
ZTFE3020	C83, C113	MT E Non-Tack Tile
ZTFE3620	C83, C113	MT E Non-Tack Tile
ZTFE4220	C83, C113	MT E Non-Tack Tile
ZTFE4820	C83, C113	MT E Non-Tack Tile
ZTGE2420	C119	MT E Glass Tile Pkg
ZTGE3020	C119	MT E Glass Tile Pkg
ZTGE3620	C119	MT E Glass Tile Pkg
ZTGE4220	C119	MT E Glass Tile Pkg
ZTGE4820	C119	MT E Glass Tile Pkg
ZTHE2413	C111	MT E HP Acst Tile
ZTHE2420	C111	MT E HP Acst Tile
ZTHE3013	C111	MT E HP Acst Tile
ZTHE3020	C111	MT E HP Acst Tile

Style Number	Page	Description
ZTHE3613	C111	MT E HP Acst Tile
ZTHE3620	C111	MT E HP Acst Tile
ZTHE4213	C111	MT E HP Acst Tile
ZTHE4220	C111	MT E HP Acst Tile
ZTHE4813	C111	MT E HP Acst Tile
ZTHE4820	C111	MT E HP Acst Tile
ZTLE2413	C115	MT E Laminate Tile
ZTLE2420	C115	MT E Laminate Tile
ZTLE3013	C115	MT E Laminate Tile
ZTLE3020	C115	MT E Laminate Tile
ZTLE3613	C115	MT E Laminate Tile
ZTLE3620	C115	MT E Laminate Tile
ZTLE4213	C115	MT E Laminate Tile
ZTLE4220	C115	MT E Laminate Tile
ZTLE4813	C115	MT E Laminate Tile
ZTLE4820	C115	MT E Laminate Tile
ZTME2420	C117	MT E Markerboard Tile
ZTME3020	C117	MT E Markerboard Tile
ZTME3620	C117	MT E Markerboard Tile
ZTME4220	C117	MT E Markerboard Tile
ZTME4820	C117	MT E Markerboard Tile
ZTSE2413	C113	MT E Non-Tack Tile
ZTSE2420	C113	MT E Non-Tack Tile
ZTSE3013	C113	MT E Non-Tack Tile
ZTSE3020	C113	MT E Non-Tack Tile
ZTSE3613	C113	MT E Non-Tack Tile
ZTSE3620	C113	MT E Non-Tack Tile
ZTSE4213	C113	MT E Non-Tack Tile
ZTSE4220	C113	MT E Non-Tack Tile
ZTSE4813	C113	MT E Non-Tack Tile
ZTSE4820	C113	MT E Non-Tack Tile
ZTVE2413	C114	MT E Galvanized Tile
ZTVE2420	C114	MT E Galvanized Tile
ZTVE3013	C114	MT E Galvanized Tile
ZTVE3020	C114	MT E Galvanized Tile
ZTVE3613	C114	MT E Galvanized Tile
ZTVE3620	C114	MT E Galvanized Tile
ZTVE4213	C114	MT E Galvanized Tile
ZTVE4220	C114	MT E Galvanized Tile
ZTVE4813	C114	MT E Galvanized Tile
ZTVE4820	C114	MT E Galvanized Tile
ZTWE2413	C116	MT E Wood Tile
ZTWE2420	C116	MT E Wood Tile
ZTWE3013	C116	MT E Wood Tile
ZTWE3020	C116	MT E Wood Tile
ZTWE3613	C116	MT E Wood Tile
ZTWE3620	C116	MT E Wood Tile
ZTWE4213	C116	MT E Wood Tile
ZTWE4220	C116	MT E Wood Tile
ZTWE4813	C116	MT E Wood Tile
ZTWE4820	C116	MT E Wood Tile
ZU24BBFLR	C163	MT Fixed Pedestal
ZU24BBFLROM	C164	MT Fixed Pedestal
ZU24BBFLW	C163	MT Fixed Pedestal
ZU24BBFLWOM	C164	MT Fixed Pedestal

Style Number	Page	Description
ZU24FFLR	C163	MT Fixed Pedestal
ZU24FFLROM	C164	MT Fixed Pedestal
ZU24FFLW	C163	MT Fixed Pedestal
ZU24FFLWOM	C164	MT Fixed Pedestal
ZU30BBFLR	C163	MT Fixed Pedestal
ZU30BBFLROM	C164	MT Fixed Pedestal
ZU30BBFLW	C163	MT Fixed Pedestal
ZU30BBFLWOM	C164	MT Fixed Pedestal
ZU30FFLR	C163	MT Fixed Pedestal
ZU30FFLROM	C164	MT Fixed Pedestal
ZU30FFLW	C163	MT Fixed Pedestal
ZU30FFLWOM	C164	MT Fixed Pedestal
ZUBBF24MWC	C211	MT WS Metal Pedestal
ZUBBF24MWR	C211	MT WS Metal Pedestal
ZUBBF24MWW	C211	MT WS Metal Pedestal
ZUBBF24WCOM	C209	MT WS Metal Pedestal
ZUBBF24WROM	C209	MT WS Metal Pedestal
ZUBBF24WWOM	C209	MT WS Metal Pedestal
ZUBBF30MWC	C211	MT WS Metal Pedestal
ZUBBF30MWR	C211	MT WS Metal Pedestal
ZUBBF30MWW	C211	MT WS Metal Pedestal
ZUBBF30WCOM	C209	MT WS Metal Pedestal
ZUBBF30WROM	C209	MT WS Metal Pedestal
ZUBBF30WWOM	C209	MT WS Metal Pedestal
ZUFF24MWC	C211	MT WS Metal Pedestal
ZUFF24MWR	C211	MT WS Metal Pedestal
ZUFF24MWW	C211	MT WS Metal Pedestal
ZUFF24WCOM	C209	MT WS Metal Pedestal
ZUFF24WROM	C209	MT WS Metal Pedestal
ZUFF24WWOM	C209	MT WS Metal Pedestal
ZUFF30MWC	C211	MT WS Metal Pedestal
ZUFF30MWR	C211	MT WS Metal Pedestal
ZUFF30MWW	C211	MT WS Metal Pedestal
ZUFF30WCOM	C209	MT WS Metal Pedestal
ZUFF30WROM	C209	MT WS Metal Pedestal
ZUFF30WWOM	C209	MT WS Metal Pedestal
ZWCB	C187	MT WS Cmr Wksf Brkt
ZWM13	C234, C250	MT Vert Wire Mgr
ZWM20	C234, C250	MT Vert Wire Mgr
ZWS86	C66	MT Wall-Attach Brkt

Trademark List

- ® The following registered trademarks are used under license from Steelcase Development Corporation: Accelerate, Ally, Answer, Anthem, Arrondi, Avenir, Ballet, Bix, Brayton International Collection, Brayton Textile Collection, Breton, Canto, Chancellor, Collegium, Company, Concentrx, Context, Criterion, Crushed Can, Decorum, Designtex, Details, Drive, Elective Elements, Ellipse, Ember Chrome, Emerge, Etude, Exclamation Mark, Firstfile, Gentry, Ginkgo, Ginkgo Biloba, Hardwear, Ideo, Internode, Jersey, Kart, Kick, LaCosta, Latour, Leap, Let's B, Lucy, Lyra, Lytyn, Manhattan Product Configuration, Max-Stacker, Media Dock, Metro, Migrations, Miko, Montage, Oriana, Parade, Pathways, Perfect Match, Player, Power Pincher, Portal, Protégé, Raf System, Rally, Rapport, Relevant, Reply, Sensor, Series 9000, Springboard, Steelcase, Steelcase Design Partnership, Steelcase Workplace Performance, Stow Davis, TeamWork, Technique, Texpress, Treehouse, Trilogy, Turnstone, Vecta, Vectaflex, Werndl, Wizard, and Workflo.
- ® The following is a registered trademark of Byrne Electrical, Rockford, Michigan: Interport.
- ® The following is a registered trademark of Genlyte Thomas Company, Louisville, KY: Lightolier.
- ® The following is a registered trademark of Leviton Manufacturing Company, Little Neck, NY: Decora.
- ® The following is a registered trademark of Microsoft Corporation, Redmond, WA: Microsoft.
- ® The following is a registered trademark of Panduit Corporation, Lockport, IL: Panduit.
- ® The following is a registered trademark of Trav (Press), Cuneo, Italy: Assisa.
- ® The following is a registered trademark of Virtual Ink Corporation: mimioActive.
- ® The following registered trademarks are under license from Wilkhahn Furniture Products: Avera, Confair, Senzo, Versal, and Wilkhahn FS.

- ™ The following trademarks are used under license from Steelcase Development Corporation: 4 o'clock, à la carte, Active/Passive Shelf, Activity Products, Adia, Alcove, Alerion, Alexander Street Collection, Aliso, Allegro, Alongside, American Elect, American Tradition, Anson, Arbor, Archipelago, Archive Collection, Arriva, Ascot, Astor, Austin, Avalon, Bira, Bonn, Boomerang, Bradbury, Breadbox, Brio, Buxton, Cachet, Callahan, Camber, Canopy, Cappucino, Catalina, CbP, Chester, Chorus, Chronos, Ciao, Clarendon, Classic Rectangular, Collaboration, Collins, Cologne, Colorbox, Common (Shelf), Commons, Community, Community based Planning CbP, Convene, Convey, Cortex, Cosima, Croix, Cubby, Cubis, Cushion, Customiz, Dataduct, Datum, Deck, Dedoes, Déjà, Detour, Detriana, DNA, Domain, Donovan, Dorchester, Downspout, Drop Top Hutch, Duospace, Eastlake, Eastridge, Eco, Ella, Elsa, Emmy, Encounter, Enea, EnSync, Ensemble, Entourage, Environmental Impact Collection, Equinox, Escapade, Et Al, E-Table, Exponents, Express12, Extreme Conditions, Fillmore, Flat Top, Fling, Flip Top, Footnote, Fortuna, Frontier, Fuji, Futu, Galilei, Galveston, Garland, Ginger, Glenwood, Go Wall, Greco, Greenbrier, Grip, Groove, Groupwork, Hannah, Hatch, Hatchback, Hatteras, Health Design, Hitch, Huddleboard, Impact, Incognito, Indy, InfoWizard, InterAct, IOS, I-Solve, Jacket, Jenny, Jetty, Juice, Kendo, Kiana, L'Attitude, Lazlo, Lean Too, Lemon, Lift-N-Slide, Lotus, Lyric, M/O, Malibu, Manhattan, Mansfield, Martini, Masque, Mingle, Monterey, Montreal, MyWizard, Nadia, Nickel, Nine, Ontrak, Onyx, Outlook, Paloma, Parliament, Parts Advantage, Pasio, Passarelle, Patriarch, Patterson, Payback, Peek, Pendio, Personal Border, Pier Top, Pipe, Pisa, Playback, Portal, Progeny, Radio, Rag Top, Rei, Reunion, Rhine, Rialto, Ricetta, Riser, Rizzi Arc, Rocco, RoomWizard, Rover, Runaround, Runner, Satellite, Scribe, Shadow, Shield, Shortbed, Skinny, Sidebar, Sidewalk, Sieste, Sine, Smoke, Snug, Softwork, Spinz, Sportswear, St. Clair, Stationkits, Stiletto, Stuttgart, Super Shelf, Surprise!, Switch, Template, Terrazzo, Tessare, Theorem, Think, Topaz, Topo, Top Spin, Touchdown, Train, Trolley, T-Wall, Umbrella, Underline, Unison, Uno, Utility Bar, Venetia, Walden, Warehouse, Whittier, Windsor, Wizard WebSigns, Your Profile, Your Power, and Your Preference.
- ™ The following is a trademark of Microsoft Corporation, Redmond, WA: Windows.
- ™ The following is a trademark of Ultrafabrics, LLC, Elmsford, NY: Ultraleather.
- ™ The following trademarks are used under license from Wilkhahn Furniture: Cana, Linus, Logon, Picto, Range, Stitz, Thema, Timetable, and Tubis.