



GREAT
OPENINGS

TRACE_® desk

TRACE DESK PRICE BOOK

February, 2013

rev 08.28.2015

Revision Levels

Date	Changes Made
04.15.2014	Added HW Lock, Removed Fabrics 7E Golden & 7L Deep Forest - Added 7T Butterscotch & 7V Sherwood
11.12.2014	Updated "Remit to" address in terms and conditions
11.12.2014	Updated page 23 - removed extra "ED" part # to reflect accurately
11.21.2014	Updated page 25 - added statement about "To add a loop pull (S:Satin...." Under Wall-Mounted Overhead - Horizontal Bracket Over-the-Top Stowing Door
11.21.2014	Page 9 - Updated SL and ML locks
01.15.2015	Page 25 - Changed to no up-charge for satin nickel pull on overhead, page 29- removed plastic center drawer
08.14.2015	Page 5 - Corrected laminate thickness 1.25"
08.18.2015	Page 25 - removed "Horizontal Bracket" term from tack board
08.28.2015	Page 29 - Added Wire Tray



	Page
Specification Guide	
Quick Reference for Ordering	2
Paint Program	3
Laminate Program	4
Specialty Fronts	5
Laminate, Edge Specifications	6
Fabric Program	7
Ordering COM Fabrics	8
Lock Program	9
Trace Freestanding Desk	
Desk FAQs	10
Typical Desk Workstations	13
Bare Bones Desks	15
Desk Shells	16
Single and Double Pedestal Desks	18
Return Shells	19
Peninsulas	20
Corners & Extended Corners	21
Bridges	24
Desk Hutches & Overhead Storage	25
File Hutch & Transaction Counter	26
Privacy Screens	27
Desk Accessories	28
Desk Components Sold Separately	30
Terms and Conditions	
Commercial	34
GSA	36

TRACE Desk Price Book

February, 2013

[rev 08.28.2015](#)

Great Openings
902 E. 4th Street
Ludington, MI 49431

Customer Service:
Phone: 888-712-8582
Fax: 231-843-6373
greatopeningscust.serv@greatopenings.com

www.greatopenings.com
Printed Literature: www.goliterature.com

QUICK REFERENCE FOR ORDERING

SEE PAGE 2 FOR COLORS, LAMINATES, FABRICS

All drawer fronts are not available on all products. For restrictions see the individual product pages.



A: Full Pull



Q: Square, Satin Nickel Bar Pull



S: Square, Satin Nickel Loop Pull
(Add "B" suffix for black pull)



Y: Square, Black Wire Pull



B: S-9000 Pull



F: Square, Recessed Pull



H: Square, HW Pull



P: Square, P Pull



D: Radiused, Recessed Pull



I: Radiused, HW Pull



N: Radiused, Satin Nickel Loop Pull
(Add "B" suffix for black pull)

D: and F: Recessed Pull Colors:

- 0256 Black Umber
- 0257 Light Grey
- 0004 Medium Tone

Products ordered in any other color will include 0256 Black Umber pulls

P: Square Front "P" Pull Colors:

- 0159 Beige
- 0006 Charcoal
- 0547 Graphite
- 0131 Smoke

Products ordered in any other color will include 0006 Charcoal pulls

PAINT FINISHES

Great Openings Standard Colors

Allsteel

- 0217 Brilliant White
- 01A7 Champagne Metallic
- 0073 Cloud
- 0232 Driftwood
- 0231 Flint
- 0536 Loft
- 0683 Muslin
- 0345 Parchment
- 0166 Platinum Metallic
- 0152 Tan

Herman Miller

- 0256 Black Umber
- 0257 Light Grey
- 0004 Medium Tone
- 0994 Metallic Bronze
- 0744 Metallic Champagne
- 0666 Silver Metallic
- 02L6 Soft White
- 0784 Warm Grey Neutral
- 0670 White
- 0515 WL Sandstone

Steelcase

- 0995 Arctic White Textured
- 0668 Black Textured
- 0044 Black
- 0998 Carbon Metallic Textured
- 0678 Fieldstone Textured
- 0722 Midnight Textured
- 02A4 Milk
- 0666 Platinum Metallic
- 0705 Sterling Metallic
- 0280 Warm White

Haworth

- 0159 Beige
- 02Z8 Cement Textured
- 0141 Chalk
- 0006 Charcoal
- 0547 Graphite
- 0205 Greystone
- 02Z9 Grout Textured
- 0112 Putty
- 2Y9P Silver Metallic
- 0131 Smoke

Knoll

- 0968 Beige Mist Metallic
- 02Z2 Bright White Smooth
- 02Z3 Bright White Textured
- 02Y7 Brown
- 0623 Folkstone Grey
- 0188 Medium Grey
- 02Y6 Medium Metallic Grey
- 0756 Sandstone
- 02X9 Silver Metallic
- 0030 Soft Grey

Teknion

- 02M0 Arctic Textured
- 02X5 Espresso Textured
- 02M3 Granite
- 02A3 Grey
- 02U2 Latte Textured
- 02M2 Nevada
- 02X7 Platinum Metallic
- 02Z0 Satin Black
- 02X4 Silver Textured
- 02N0 Storm White Textured

LAMINATES

GO Part

- AWAW
- BNBN
- BKBK
- BTBT
- CZSG
- DWDW
- DZDZ
- FGFG
- FMFM
- GNGN
- GYGY
- MPMP
- PDPD
- SNPD
- SLSL
- TTPT
- WCWC
- WWMW

Laminate

- Antique White
- Beige Nebula
- Black
- Brighton Walnut
- Canyon Zephyr
- Designer White
- Dessert Zephyr
- Fashion Grey
- Fusion Maple
- Grey Nebula
- Grey Mesh
- Monticello Maple
- Pepperdust
- Silicon
- Steel Mesh
- Titanium
- Wild Cherry
- Windsor Mahogany

3mm PVC Trim

- Antique White
- Beige Nebula
- Black
- Brighton Walnut
- Shadow
- Designer White
- Dessert Zephyr
- Fusion Maple
- Grey Nebula
- Grey Mesh
- Monticello Maple
- Pepperdust
- Pepperdust
- Steel Mesh
- Platinum
- Wild Cherry
- Windsor Mahogany

FABRICS

GO Part

- 7A
- 7B
- 7C
- 7D
- 7E
- 7G
- D1
- 7J
- 7K
- 7L
- 7M
- 7N
- 7P
- 7S
- 7R

Color Name

- Black
- Grey
- Nickel
- Jodhpurs
- Golden
- Fire
- Aubergine
- Steel
- Navy
- Deep Forest
- Nile
- Night Shadow
- Crocodile
- Marigold
- Raspberry

All Great Openings products are finished with a hybrid powder formula (epoxy and polyester), which ensures an exceptionally durable, consistent finish. Simply select from our 60 Standard Colors, Industry Favorites (viewed online), or Custom Colors.

60 Standard Colors

All at standard lead times and price, standard colors are smooth, except those identified as textured.

Allsteel

0217 Brilliant White
01A7 Champagne Metallic
0073 Cloud
0232 Driftwood
0231 Flint
0536 Loft
0683 Muslin
0345 Parchment
0166 Platinum Metallic
0152 Tan

Herman Miller

0256 Black Umber
0257 Light Grey
0004 Medium Tone
0994 Metallic Bronze
0744 Metallic Champagne
0666 Silver Metallic
02L6 Soft White
0784 Warm Grey Neutral
0670 White
0515 WL Sandstone

Steelcase

0995 Arctic White Textured
0668 Black Textured
0044 Black
0998 Carbon Metallic Textured
0678 Fieldstone Textured
0722 Midnight Textured
02A4 Milk
0666 Platinum Metallic
0705 Sterling Metallic
0280 Warm White

Haworth

0159 Beige
02Z8 Cement Textured
0141 Chalk
0006 Charcoal
0547 Graphite
0205 Greytone
02Z9 Grout Textured
0112 Putty
2Y9P Silver Metallic
0131 Smoke

Knoll

0968 Beige Mist Metallic
02Z2 Bright White Smooth
02Z3 Bright White Textured
02Y7 Brown
0623 Folkstone Grey
0188 Medium Grey
02Y6 Medium Metallic Grey
0756 Sandstone
02X9 Silver Metallic
0030 Soft Grey

Teknion

02M0 Arctic Textured
02X5 Espresso Textured
02M3 Granite
02A3 Grey
02U2 Latte Textured
02M2 Nevada
02X7 Platinum Metallic
02Z0 Satin Black
02X4 Silver Textured
02N0 Storm White Textured

Industry Favorites (viewed online)

Visit www.greatopenings.com to find a comprehensive list of colors that are available for you to order just as though they were among our 60 Standard Colors.

- No added cost
- Standard lead-time
- No minimum order size
- Not necessary to exchange paint chip samples or to get your signed approval, as we already know we have a good match with the original manufacturer's color
- Simply send us your purchase order with the paint color name and number identified in this online list

- Great Openings will process your order, then send you an order acknowledgement
- Depending on paint cost and availability that is beyond our control, colors may be added or removed from this list of Industry Favorites

Please understand that color match is not a perfect science. While Great Openings uses the most sophisticated powder formula color match technology available, our greatest challenge remains the fact that the major manufacturers' colors tend to "drift" over time. Bright whites and silver metallics, in particular, are a challenge to match. For all practical purposes, in common artificial light as well as natural light, Great Openings' Industry Favorites will be an excellent match for our competitors' colors.

Custom Colors

When you need a color that's not included in our 60 Standard Colors or Industry Favorites, simply send us a paint chip and we'll get it matched. A special lead time or cost will likely be included, but we can almost certainly supply exactly the color you need.

- No minimum order size on Custom Colors
- Custom Color up-charge is applied on a per unit basis
- Minimum lead-time is 15 working days after we receive your written color approval
- We must receive a purchase order before exchanging custom color samples.

Check our website for Custom Designer Colors, a sampling of trending new custom colors!

Here's how it works for custom colors:

1. Along with your purchase order, send us a 2" X 2" sample of your desired Custom Color (a metal chip is best, but often a laminate or paper sample will work).
2. We'll work with our paint suppliers to find a match, a process that typically takes 10 to 15 business days. Then we'll send a metal sample of our recommended paint color back to you, along with a sign-off sheet, total net up-charge, and lead-time requirements.
3. You'll return the sign-off sheet, we'll send you an order acknowledgement, and away we go!

Please note: Our objective is to order exactly the correct amount of paint for each order so that we can offer you the lowest possible price. For this reason, if you happen to order the same custom color again weeks, months, or years later, paint inventory will likely not exist and any additional costs will once again be charged per unit, no matter the order size.

LAMINATE PROGRAM

SEE PAGE 2 FOR COLORS, LAMINATES, FABRICS

We make it easy to order special laminates and edge bands. Great Openings offers 18 Standard Laminate and Edge options as well as Custom Laminates.

Cayenne laminate tops are 5/8" thick and may be ordered with any of our 18 Standard Laminate and Edge options, or from our Custom Laminate program, both shown below. 5/8" thick laminate tops **may not** be used as desk work surfaces. Laminate tops used for the TRACE desk or any TRACE cabinet top are 1-1/4" thick, and may be ordered from any of the three laminate programs shown below.

18 Standard Laminates and Edges

For laminate samples please contact Wilsonart® at 800-433-3222, or see www.wilsonart.com

GO Part #	Laminate	Cross Reference Wilsonart®	3mm PVC Trim
AWAW	Antique White	1572-60	Antique White
BNBN	Beige Nebula	4624-60	Beige Nebula
BKBK	Black	1595-60	Black
BTBT	Brighton Walnut	7922-38	Brighton Walnut
CZSG	Canyon Zephyr	4842-60	Shadow
DWDW	Designer White	D354-60	Designer White
DZDZ	Desert Zephyr	4841-60	Desert Zephyr
FGFG	Fashion Grey	381-60	Fashion Grey
FMFM	Fusion Maple	7909-60	Fusion Maple
GNGN	Grey Nebula	4622-60	Grey Nebula
GYGY	Grey Mesh	4877-38	Grey Mesh
MPMP	Monticello Maple	7925-38	Monticello Maple
PDPD	Pepperdust	327-60	Pepperdust
SNPD	Silicon	4811-60	Pepperdust
SLSL	Steel Mesh	4879-38	Steel Mesh
TTPT	Titanium	4810-60	Platinum
WCWC	Wild Cherry	7054-60	Wild Cherry
WMWM	Windsor Mahogany	7039-38	Windsor Mahogany

Custom Laminates (including veneers)

When you need a laminate or edge band that's not included in our 18 Standard Laminates & Edges, call Great Openings to request a special quote and lead-time. We have access to WilsonArt®, Formica®, Nevamar®, Pionite® and many more.

Please note that custom laminates or edges will require additional charges, lead-time, and minimum order quantities.

When it's time to place your custom laminate order, include the following information on your PO:

- name of your laminate and edge
- manufacturer names
- pattern names
- identification numbers

Custom laminates and edges cannot be changed or cancelled after the order has been confirmed by our Customer Service Department and an order acknowledgement has been sent.

Standard Work Surface Specifications:

Core material:	Trace desk work surfaces: 1.25" thick 45 lb. density particle core Cayenne tops: .625" thick, 45lb. density partical core
Adhesive:	Water based, formaldehyde free, GREENGUARD® Certified.
Backer material:	.028 phenolic
Finished Thickness:	Trace desk work surfaces: 1.25" Cayenne tops: .705"
Drill locator holes:	Locator holes strategically placed to align support elements.
Green properties:	<ul style="list-style-type: none">• 100% pre-consumer recycled wood fiber• Meets California Air Resources Board (CARB) Regulation 93120.2, Phase 1 emission limits
LEED-CI V2.0	Credit and point Information: <ul style="list-style-type: none">• MR Credit 4.1 Recycled Content, 10% (post consumer + 1/2 pre-consumer - 1 Point)• MR Credit 4.1 Recycled Content, 20% (post consumer + 1/2 pre-consumer - 1 Point)

Standard Laminate and Edge Trim Specifications

HP laminate:	Wilsonart, GREENGUARD® Certified.
Laminate material:	High pressure.
Laminate grade:	.040 horizontal
Laminate finish:	#60 or #38 finish
Edge trim:	3mm PVC, vinyl square

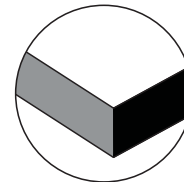

3mm PVC
Edge Band

Environmentally Friendly Laminate Substrate:





Work surfaces with NAUF Substrate (No Added Urea-Formaldehyde Particleboard), ABS Edge, and Marmoleum are available for order. Call Customer Service or Sales for more information.

SPECIALTY FRONTS AND OPTIONS

SEE PAGE 2 FOR COLORS, LAMINATES, FABRICS

Products Available with Laminate Fronts

Any of the following Great Openings cabinets may be special-ordered to include factory-installed laminate fronts. Laminates may be one of Great Openings' standards, or a special ordered laminate and 3mm edge band. Laminate wood grain is positioned vertically on all fronts, including tower doors. Laminate fronts must be specified to include any one of our loop pulls. UM Series locks are included as standard. Please call Sales for a quote.

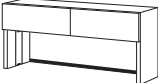
	Notes	Product
	Cayenne drawer fronts are full width, and the lock is located in the bottom drawer.	Cayenne two drawer cabinet (any width)
	Pedestal drawer fronts and lock strip will be laminate. Cushion pedestals will not include a loop pull on the lock strip. Not available on 3" pencil drawers.	box/file pedestal file/file pedestal box/box/file pedestal
	Lateral drawer fronts and lock strip will be laminate.	Trace box/file lateral (any width) Trace 2-high lateral (any width) Trace 3-high lateral (any width) Trace 4-high lateral (any width) Trace 5-high lateral (any width) Trace 6-high lateral (any width)
	Laminate drawer and door fronts are full-width. The tower top and base are both visible from the front of the cabinet, and will be metal.	Cupboard wardrobe tower (any height)
	Hutch doors are full width, and do not include loop pulls. Locks are concealed below the shelf.	Trace desk hutch doors (any width)

Additional mixed material front options

Most of Great Openings cabinets may also be ordered with special veneer fronts or framed aluminum doors with acrylic inserts.

Please contact the GO Sales Team for a quote.

Digital lock options

Many of Great Openings cabinets may also be ordered with individually keyed digital locks. Please contact the GO Sales Team for a quote.

Custom Products

Towers and lockers specially-designed with a custom height, width, or depth may be available for sufficient quantities.

Standard Fabric Program:

This fabric offering may be applied to our Cushion Mobile Pedestals, GO Carts, Cushion Mobile FileCenters, Desk Hutch Tack Boards, Wall-Mounted Tack Boards and Privacy Screens. We have selected a pallet of fifteen accent colors from the C.F. Stinson colors – New Hempstead and Bryant Park Collections. This fabric is a low texture, solid-color, 100% polyester that will work very well as seating upholstery or for a vertical tack board application. The following is a cross reference list for these fabrics:

GO Part #	Fabric	C.F. Stinson
7A	Black	NH333 - New Hempstead
7B	Grey	NH395 - New Hempstead
7C	Nickel	NH361 - New Hempstead
7D	Jodhpurs	NH420 - New Hempstead
7G	Fire	NH406 - New Hempstead
D1	Aubergine	NH419 - New Hempstead
7J	Steel	NH366 - New Hempstead
7K	Navy	NH369 - New Hempstead
7M	Nile	BP6553 - Bryant Park
7N	Night Shadow	BP6563 - Bryant Park
7P	Crocodile	BP6561 - Bryant Park
7S	Marigold	BP6551 - Bryant Park
7R	Raspberry	BP6557 - Bryant Park
7T	Butterscotch	6531 Ace
7V	Sherwood	6544 Ace

For memo samples, contact C.F. Stinson at 800-841-6279 or see www.cfstinson.com.

Fabric Specifications:

- Contents..... 100% polyester
- Finish..... Soil and stain protective finish
- Abrasion Resistance (astm d-4157)..... Exceeds 100,000 (Bryant Park), and 800,000 (New Hempstead) double rubs (heavy duty Wyzenbeek Method)
- Color Fastness - Light (aatcc-16)..... 40 hours class 4 minutes (New Hempstead), and 5 minutes (Bryant Park)
- Crocking (aatcc-8)..... (dry) class 4.5 minutes (wet) class 4.5 minutes
- Flammability:
- Calif. 191-53 Tech. Bulletin 117, Section E..... Passes
- UFAC and BIFMA..... Class 1
- Cleaning (w-s)..... Professional service is recommended or use water-based agents

ORDERING COM FABRICS

HOW TO SPECIFY COM FABRIC ON YOUR PURCHASE ORDER:







Calculate the yards of fabric needed using the chart below. If ordering more than 10 identical units, call for fabric requirements

Clearly label your fabric package with:

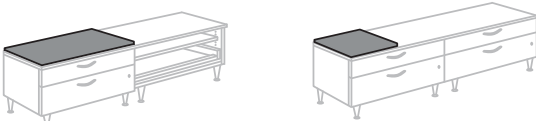
- Purchase order #
- Dealer name
- Fabric description
- Yardage quantity enclosed



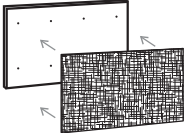



Please note: Lead-time for COM fabric orders is 10 working days after receipt of fabric. Great Openings reserves the right to refuse to apply any COM fabric that we deem insufficient quality for production or user application. Our standard warranty does not apply to COM fabric-covered items.

Send the fabric to:
Great Openings (Fabric), 902 East Fourth St., Ludington, MI 49431

Product	Required Yardage
 <p data-bbox="428 709 578 730">Cayenne Cushion</p>	<p data-bbox="875 552 1117 573">Required for 54" or 66" fabric</p> <ul data-bbox="875 573 1179 730" style="list-style-type: none"> 12" wide cushion (1/2 linear yard) 18" wide cushion (2/3 linear yard) 30" wide cushion (1 linear yard) 36" wide cushion (1-1/4 linear yards) 42" wide cushion (1-1/3 linear yards) 60" wide cushion (2 linear yards) 66" wide cushion (2 linear yards) 72" wide cushion (2-1/4 linear yards)
 <p data-bbox="428 894 578 915">Cushion Pedestal</p>	<p data-bbox="875 768 1117 789">Required for 54" or 66" fabric</p> <p data-bbox="875 810 1045 831">1 linear yard per unit</p>
 <p data-bbox="290 1066 451 1087">Cushion FileCenter</p> <p data-bbox="630 1066 703 1087">GO Cart</p>	<p data-bbox="875 951 1117 972">Required for 54" or 66" fabric</p> <p data-bbox="875 993 1045 1014">1 linear yard per unit</p>
 <p data-bbox="371 1241 638 1262">Trace Box/File Lateral Cushions</p>	<p data-bbox="875 1125 1117 1146">Required for 54" or 66" fabric</p> <ul data-bbox="875 1167 1271 1188" style="list-style-type: none"> • 30", 36", and 42" wide laterals (3/4 linear yard)
 <p data-bbox="313 1461 695 1482">Wall-Mounted Tack Board - Horizontal Bracket</p>	<p data-bbox="875 1308 1117 1329">Required for 54" or 66" fabric</p> <ul data-bbox="875 1350 1369 1482" style="list-style-type: none"> • 24" wide tack board requires 36" fabric (1 linear yard) • 30" wide tack board requires 36" fabric (1 linear yard) • 36" wide tack board requires 42" fabric (1-1/2 linear yards) • 42" wide tack board requires 48" fabric (1-1/2 linear yards) • 48" wide tack board requires 54" fabric (1-1/2 linear yards) • 54" wide tack board requires 66" fabric (2 linear yards) • 60" wide tack board requires 66" fabric (2 linear yards)
 <p data-bbox="290 1696 386 1717">Desk Hutch</p> <p data-bbox="573 1696 743 1717">Transaction Counter</p>	<p data-bbox="875 1518 1117 1539">Required for 54" or 66" fabric</p> <ul data-bbox="875 1560 1369 1717" style="list-style-type: none"> • 36" wide tack board requires 42" fabric (1-1/2 linear yard) • 42" wide tack board requires 48" fabric (1-1/2 linear yards) • 48" wide tack board requires 54" fabric (1-1/2 linear yards) • 54" wide tack board requires 66" fabric (2 linear yards) • 60" wide tack board requires 66" fabric (2 linear yards) • 66" wide tack board requires 72" fabric (2 linear yards) • 72" wide tack board requires 77" fabric (2-1/2 linear yards)
 <p data-bbox="269 1875 418 1896">Rectangle Screen</p> <p data-bbox="553 1875 773 1896">Scalloped-Shaped Screen</p>	<p data-bbox="875 1766 1117 1787">Required for 54" or 66" fabric</p> <ul data-bbox="875 1808 1336 1969" style="list-style-type: none"> • 23" wide screen requires 29" fabric (1 linear yard) • 29" wide screen requires 35" fabric (1 linear yard) • 35" wide screen requires 41" fabric (1-1/2 linear yards) • 41" wide screen requires 47" fabric (1-1/2 linear yards) • 47" wide screen requires 53" fabric (1-1/2 linear yards) • 59" wide screen requires 65" fabric (2 linear yards) • 65" wide screen requires 71" fabric (2 linear yards) • 71" wide screen requires 77" fabric (2-1/2 linear yards) <p data-bbox="248 1913 756 1969">The scalloped-shaped screens require the same amount of fabric as the rectangular screens. The 20-3/4" and 12" screen height dimension will be taken from the width of the cloth.</p>

LOCK PROGRAM

SEE PAGE 2 FOR COLORS, LAMINATES, FABRICS

	UM (our standard lock)	LL	SL	ML	HW	K
						
	Black Patent	Satin Nickel, Scalloped	Grey Scalloped	Grey Scalloped	Satin Nickel, Scalloped	Black Patent
Compatible with which other Manufacturers?	Herman Miller	None	Haworth SL (Not Available on TRACE Hutch)	Haworth ML (Not Available on TRACE Hutch)	Haworth HW	Knoll Series
Interchangeable with other manufacturers' locks?	Interchangeable key and core	N/A	Interchangeable key and core	Interchangeable key and core	N/A	You cannot interchange K Series cores between Great Openings and Knoll products, but our "K" keys will operate Knoll's "K" locks, and vice versa
Description	As standard, all GO products are shipped with a randomly-assigned UM lock, which is black, master-keyed, and core removable	The LL lock is master-keyed and core removable	The SL lock is master-keyed and core removable	Great Openings does not offer the Haworth ML series lock, but Haworth's ML lock cores will operate in our SL Lock mechanism. Order the SL lock and then replace the cores and keys with ML in the field. It is the dealer's responsibility to source and provide the ML cores and keys.	Great Openings does not offer the Haworth HW series lock, but Haworth's HW lock cores will operate in our LL Lock mechanism. Order the LL lock and then replace the cores and keys with HW in the field. It is the dealer's responsibility to source and provide the HW cores and keys.	Our K Series cores and keys will operate the Knoll K Series locks. Order the UM Series lock and then replace the cores and keys with K Series in the field. We support a key range of K-001 through K-100; should you require numbers K-101 through K-250, please contact Customer Service.
How to order	No special instructions are needed No extra charge	You must clearly specify "LL Series Locks" on your purchase order No extra charge	You must clearly specify "Haworth SL Series Locks" on your purchase order No extra charge	You must clearly specify "Haworth SL Series Locks" on your purchase order No extra charge	You must clearly specify "LL Series Locks" on your purchase order No extra charge	When ordering the product, no need for special ordering instructions; GO products ship as standard with UM locks You must also order K Series cores and keys separately, either random or with specified key codes No extra charge
Key # range	226 to 425 (408 & 412 not available)	226 to 325	1 to 300	N/A	N/A	1 to 250
When shipped....	UM core and key are randomly assigned	LL core and key are randomly assigned	SL core and key are randomly assigned	SL core and key are randomly assigned	LL core and key are randomly assigned	Products are shipped with UM Series lock housing, cores and keys
Key alike service available? (cores and keys will ship separately)	Yes, no charge Specify the desired key sequence on your PO, or specify "random"	Yes, no charge Specify the desired key sequence on your PO, or specify "random"	Yes, no charge Specify the desired key sequence on your PO, or specify "random"	No	No	Yes, no charge Specify the desired key sequence on your PO, or specify "random"
At installation....	No extra steps are needed	No extra steps are needed	No extra steps are needed	Remove and dispose of the SL cores and keys, then replace with ML cores and keys	Remove and dispose of the LL cores and keys, then replace with HW cores and keys	Remove and dispose of the UM Series cores and keys, then replace with K Series cores and keys

Key-Alike Process and Charges:

- Your key-alike request can be ordered on the original purchase order or under separate cover.
- Key-alike requests for the UM, SL, LL and K Series locks are processed at no charge as long as the quantity of key/core sets match the quantity of cabinets.
- When including the UM, SL, and LL Series locks, products will be shipped with randomly assigned cores/keys. Your key-alike requests for all lock series will be shipped separately and labeled to allow for easy change-out in the field, after the product is installed.
- A core-removal key is provided at no charge with each key-alike request.
- Additional keys, cores, master keys, and core keys may be purchased separately. The cost is \$3 net per item, plus \$15 net for shipping costs.

FREESTANDING DESK FAQs

SEE PAGE 2 FOR COLORS, LAMINATES, FABRICS

The Trace Freestanding Desk is a modular system of desk shells, returns, bridges, corner units, hutches, tables, and individual components that can be mixed and matched with a comprehensive selection of Great Openings storage. All components are shipped KD.

Our mission in designing the Freestanding Desk

- **Ease of specification.** All work surfaces rest primarily on panel and corner legs, rather than pedestals. Storage options are innumerable, and simply slide beneath the desk shells, return shells, and corner desks for quick installation
- **Ease of assembly.** All metal attachment points are pre-drilled, so that no "drill point" screws are required during installation. All modesty panels attach to panel legs and corner legs, rather than to pedestals
- **Ease of work surface installation.** Pre-drilled work surfaces make it easy to position legs, pedestals, and center drawers
- **Wire management.** Covered metal channels, work surface and panel leg grommets, and "place it yourself" plastic wire management channels provide a complete wire management solution
- **Clean lines.** All modesty panels are single piece, to minimize vertical lines. Desk legs, pedestals, and full height modesty panels are identical in height so that horizontal lines are consistent
- **Horizontal lines consistent with other products.** The Trace desk hutch matches the height of our 65-7/8" Trace lateral files, towers, and bookcases for consistent horizontal alignment throughout

Detailed Component Specifications

23" and 29" Panel Leg Specifications:

- Panel legs are non handed, and 27-3/4" high when leveling glides are fully recessed. Leveling glides provide 7/8" adjustment
- All panel legs are 1-1/2" wide so that work surface fasteners are positioned within the leg itself, allowing for storage to set snug against the leg
- 23" and 29" panel legs each require one gusset when no modesty panel is present
- Each leg is pre-drilled for both partial and full height modesty panel attachment
- All panel legs include (1) 18" plastic wire management channel that is equipped with adhesive strips and may be attached to a modesty panel, work surface, or storage cabinet
- 23" and 29" panel legs are available with or without two rectangular 3-1/2" x 2" plastic grommets (inside clear dimensions: 2-3/4" x 1-1/2"), positioned at the top of the leg
- Full height metal panel leg covers close-out vertical channels integrated into the panel legs (two per leg), and are sold separately. Each cover includes two grommets, located at top and bottom
- Panel legs and metal wire management covers consist of 20 gauge steel

Corner Leg Specifications:

- "L" shaped corner leg is 7-1/2" x 7-1/2", and 1-1/2" wide so that work surface fasteners are positioned within the leg itself
- Corner legs are 27-3/4" high when leveling glides are fully recessed. Leveling glides provide 7/8" adjustment
- Each leg is pre-drilled for both partial and full height modesty attachment
- All corner legs include (1) 18" plastic wire management channel that is equipped with adhesive strips and may be attached to a modesty panel, work surface, or storage cabinet
- Metal wire management cover attaches and removes easily, closing out the triangular leg to capture wires within, and are sold separately
- Corner legs and covers consist of 20 gauge steel

Post Leg:

- Post leg 27-3/4" high and 3" in diameter, with adjustable leveling glide
- Each leg is pre-drilled for both partial and full height modesty panel attachment

12" Panel Leg Specifications:

- 12" panel legs are designed to sit perpendicular to the edge of the work surface, providing additional support and knee space. 12" panel legs may not be used at the end of work surface runs
- Unlike 23" and 29" panel legs, 12" panel legs do not require gussets when there is no modesty panel because they may not be used at the end of a work surface run
- 12" panel legs may also be used in mid-run to support two work surfaces simultaneously
- Each leg is pre-drilled on both sides for both partial and full height modesty panel attachment, and are unhandled
- All panel legs include (1) 18" plastic wire management channel that is equipped with adhesive strips and may be attached to a modesty panel, work surface, or storage cabinet
- A single grommet is included at the top of each 12" panel leg. Grommets are black plastic, 3-1/2" x 2" (inside clear dimensions: 2-3/4" x 1-1/2")
- A metal wire management cover is included with each 12" panel leg
- Panel legs and covers consist of 20 gauge steel

Gussets:

- One gusset is required to support 23" and 29" panel legs when no modesty panel or pedestal positioned adjacent to the panel leg is present
- A gusset will prevent a mobile ped from sitting snugly against the panel leg
- Gussets consist of 18 gauge steel



Critical Dimensions:

Modesty Panel Specifications:

- All Trace modesty panels are single-piece construction
- Modesty panels consist of 22 gauge steel, with forms on each edge for added strength and ease of attachment to panel legs and work surfaces

Modesty Panel Offset Brackets:

- Modesty panels attach to pre-drilled holes located on the inside edges of panel legs. When a modesty panel must attach to the end of a panel leg, as with a return or bridge, then a modesty panel offset bracket is required to connect pre-drilled attachment points. Modesty panel offset brackets are included with returns and bridges, when ordered with modesty panels and are also sold separately

Work Surface Grommets:

All TRACE work surfaces come standard with one or two grommets, which are black plastic with removable covers.

- Rectangular work surfaces 60" and narrower include one grommet in center
- Rectangular work surfaces 66" and wider include two grommets, with grommet center point 20" from each side edge
- Corner desks include one grommet in corner
- Peninsulas include two grommets centered on non-rounded end

Work Surface Over-Hang:

Allow for 1/2" overhang on front, back, and sides of all desks. Work surfaces are pre-drilled for proper panel leg positioning.

Work Surface Option:

For large projects, it is possible to include metal inserts in work surfaces when required for attachment of panel legs, modesty panels, etc. Call for details.

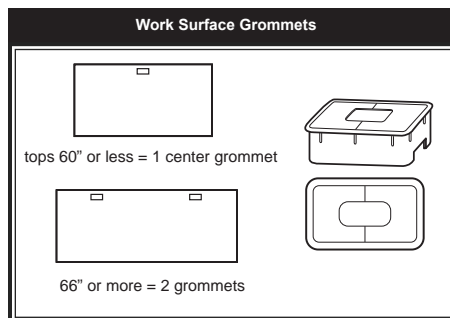
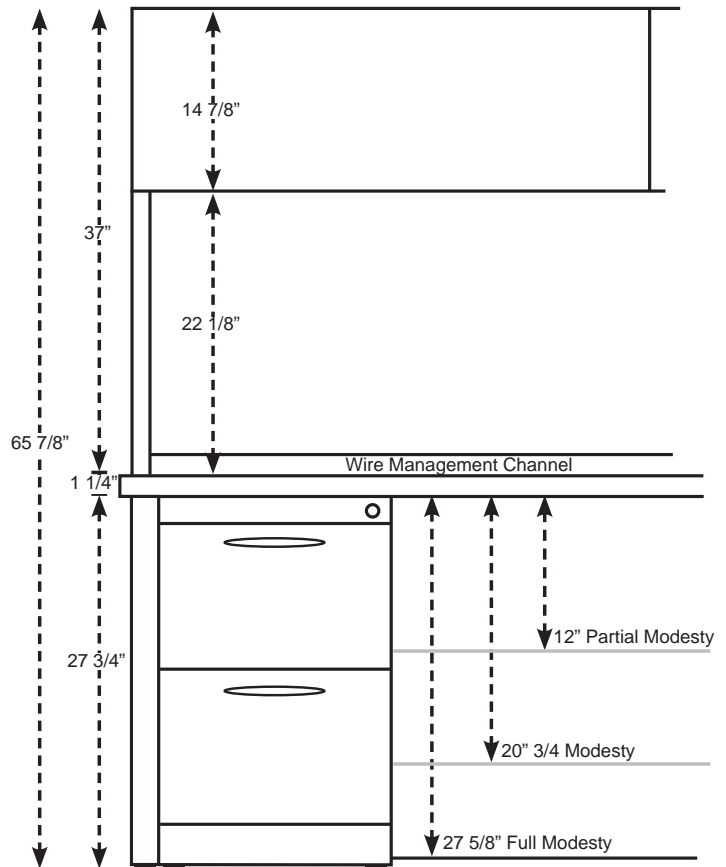

SEE PAGE 2 FOR COLORS, LAMINATES, FABRICS

Wire Management Features:

- A. Panel leg grommets available as an option with no up-charge.
- B. Plastic wire management channels - one 18" channel included with each panel and corner leg.
- C. Work surface grommets - one or two grommets included in all work surfaces.
- D. Modesty panels in three heights allow wires to run beneath.
- E. Rubber wire management strip included with each desk hutch.
- F. Task light wire channel is formed into hutch shelves.
- G. Covered vertical hutch channel for task light wire.
- H. Wire management channel covers for panel legs & corner legs are sold separately.

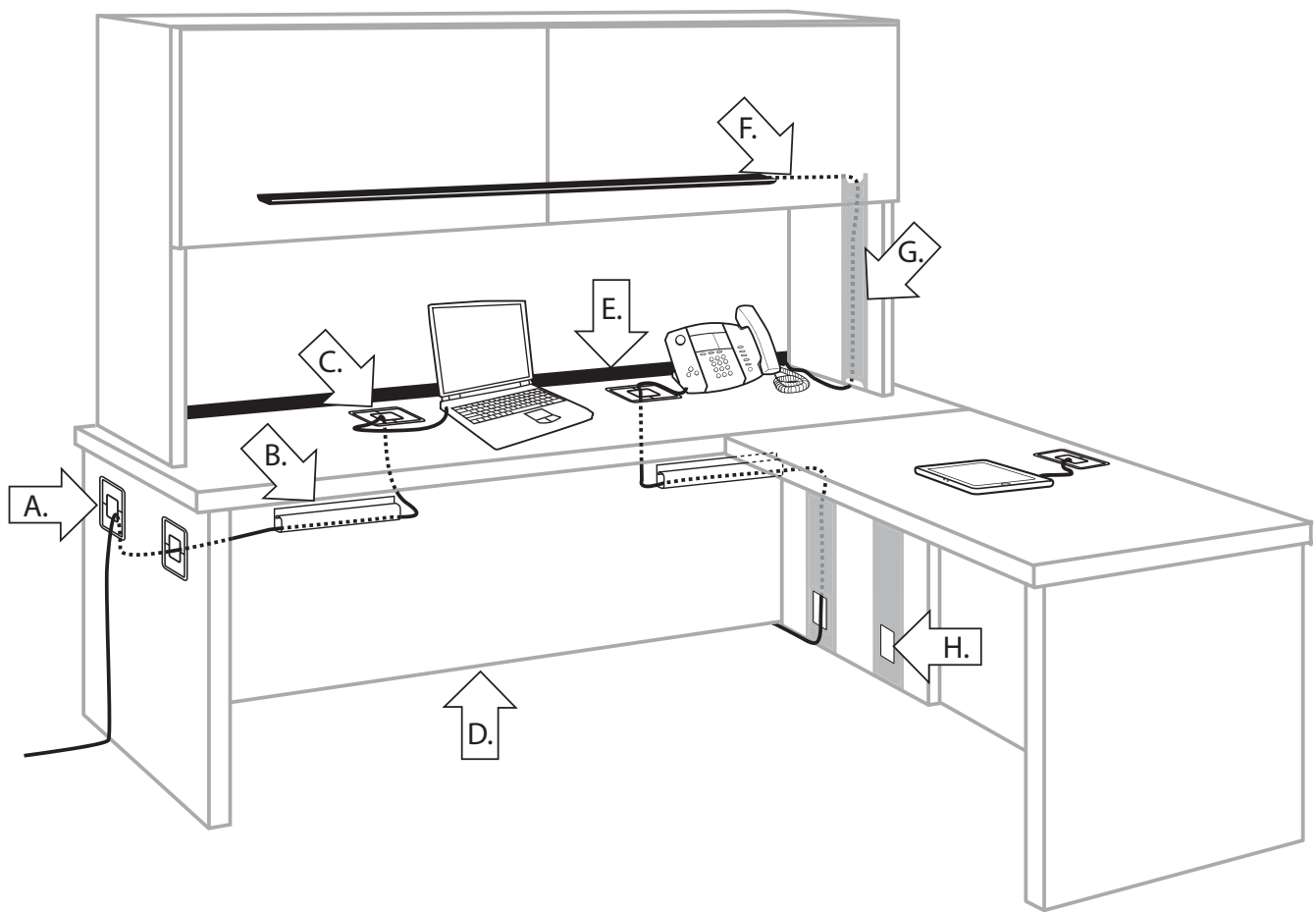

TRACE Typical 1

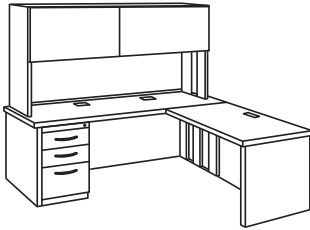

Overall Footprint: 66" deep x 60" wide

Included Elements	Qty	Product #	Price
30" x 66" desk shell, full modesty, no grommets in legs	1	DK 3066 * F	\$1,361
24" x 36" return shell, full modesty, no grommets in legs	1	RT 2436 * F	\$806
60" full desk hutch	1	HGC 6002	\$1,843
48" task light	1	VT 48-BK	\$355
28" work surface supporting pedestal, box/box/file	1	EL ? 3111	\$649
Total List Price:			\$5,014

TRACE Typical 2

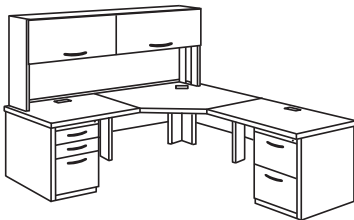

Overall Footprint: 84" deep x 72" wide

Included Elements	Qty	Product #	Price
36" corner desk, straight edge, partial modesty	1	CS 2436 P	\$1,582
24" x 36" return shell, partial modesty, no grommets in legs	1	RT 2436*P	\$775
24" x 48" return shell, partial modesty, no grommets in legs	1	RT 2448*P	\$845
72" full desk hutch with loop pulls	1	HGC 7202 L	\$1,934
48" task light	1	VT 48-BK	\$355
22" wss pedestal, box/box/file	1	EL ? 3011	\$596
22" wss pedestal, file/file	1	EL ? 3009	\$545
Total List Price:			\$6,632

TRACE Typical 3

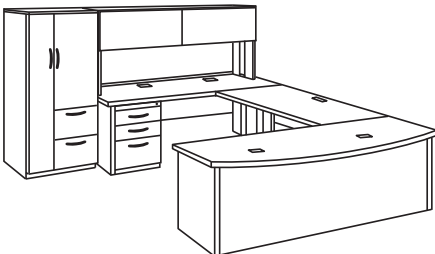

Overall Footprint: 102" deep x 96" wide

Included Elements	Qty	Product #	Price
24" x 72" desk shell, partial modesty, no grommets in legs	1	DK 2472 * P	\$1,229
72" full desk hutch	1	HGC 7202	\$1,934
48" task light	1	VT 48-BK	\$355
22" wss pedestal, box/box/file	1	EL ? 3011	\$596
36" x 72" bow front desk shell, full modesty	1	BD 3672 * F	\$1,570
24" x 42" bridge, partial modesty	1	BR 2442P	\$636
65-7/8" cupboard wardrobe tower	1	DG ? C254	\$2,234
Total List Price:			\$8,554

TRACE Typical 4

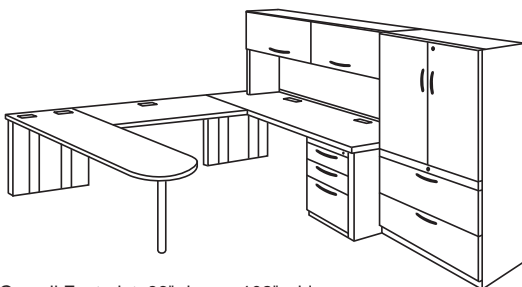

Overall Footprint: 96" deep x 102" wide

Included Elements	Qty	Product #	Price
30" x 72" desk shell, no modesty, no grommets in legs	1	DK 3072 * N	\$1,304
72" full desk hutch with loop pulls	1	HGC 7202 L	\$1,934
48" task light	1	VT 48-BK	\$355
28" wss pedestal, box/box/file	1	EL ? 3111	\$649
24" x 42" bridge, no modesty	1	BR 2442N	\$491
72" "D" peninsula, no modesty	1	PD 3072 * N	\$1,235
30" wide x 65-7/8" high combo lateral/storage cabinet	1	RG ? H1B2	\$2,047
Total List Price:			\$8,015

TRACE Typical 5

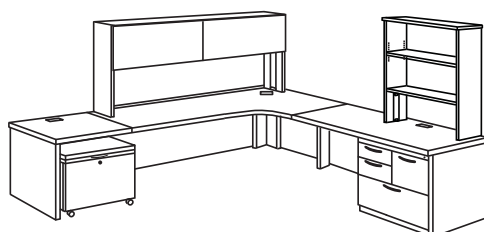

Overall Footprint: 96" deep x 90" wide

Included Elements	Qty	Product #	Price
24x48x60x30" extended corner left, full modesty	1	ET L 246030 F	\$2,230
24" x 48" return shell, full modesty	1	RT 2448 * F	\$889
30" x 30" return shell, full modesty	1	RT 3030 * F	\$876
60" full desk hutch	1	HGC 6002	\$1,843
48" task light	1	VT 48-BK	\$355
30" wide file hutch	1	FLN 3012	\$568
30-1/2" wss multidrawer filecenter	1	WL ? 0103	\$1,181
23-1/2" wide GO Cart	1	EGO 4526	\$1,200
Total List Price:			\$9,142

SEE PAGE 2 FOR COLORS, LAMINATES, FABRICS

TRACE Typical 6

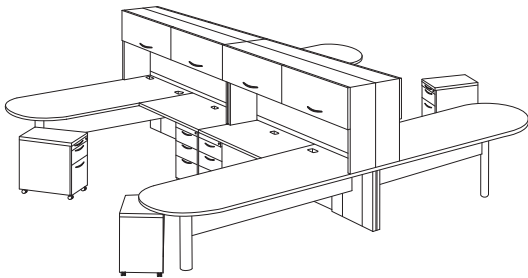

Overall Footprint: 144" deep x 144" wide

Included Elements	Qty	Product #	Price
"D" peninsula, partial modesty, 30" D x 72" W	4	PD 3072 GP	\$5,288
Return: with grommets, full mod., 24" D x 42" W	4	RT 2442 GF	\$3,476
WSS pedestal, b/b/f, 22" D x 15-1/4" W	4	EL? 3011	\$2,384
Full hutch, loop pulls on doors, 13-5/8" D x 72" W	4	HGC 7202 L	\$7,736
Cushion mobile pedestal, 22" D x 15-1/4" W	4	U? 1503 N	\$3,084
Total List Price:			\$21,968

TRACE Typical 7

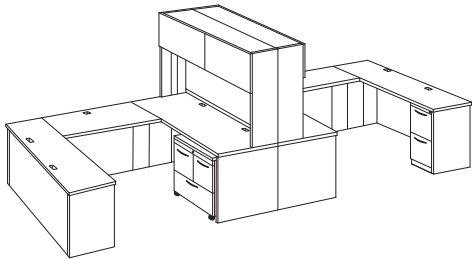

Overall Footprint: 72" deep x 192" wide

Included Elements	Qty	Product #	Price
Desk shell, no grommets, full modesty, 30" D x 72" W	2	DK 3072 *F	\$2,848
Desk shell, no grommets, full modesty, 24" D x 72" W	2	DK 2472 *F	\$2,582
Bridge: full modesty, 24" D x 42" W	2	BR 2442 F	\$1,360
Full hutch, 13-5/8" D x 72" W	2	HGC 7202 *	\$3,868
Cushion mobile filecenter, 18-3/8" D x 30-1/2" W	2	FL? 0111	\$3,912
WSS pedestal, f/f, 22" D x 15-1/4" W	2	EL? 3009	\$1,090
Total List Price:			\$15,660

TRACE Typical 8

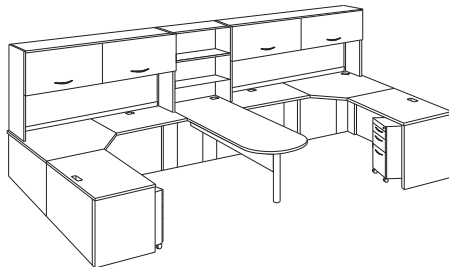

Overall Footprint: 72" deep x 174" wide

Included Elements	Qty	Product #	Price
Corner: straight edge, full modesty, 24" D x 36" W	2	CS 2436 F	\$3,264
Return: no grommets, full modesty, 24" D x 36" W	2	RT 2436 *F	\$1,612
Bridge: full mod., 24" D x 36" W	2	BR 2436 F	\$1,222
"D" peninsula, no grommets, partial modesty, 30" D x 72" W	1	PD 3072 *P	\$1,322
Full hutch, loop pulls on doors, 13-5/8" D x 72" W	2	HGC 7202 L	\$3,868
Mobile pedestal, p/b/f, 22" D x 15-1/4" W	2	EL? 1819	\$1,346
File hutch, 12-3/4" D x 30" W	1	FLN 3012	\$568
12" panel legs	2	GOL 1202	\$517
Total List Price:			\$13,719

TRACE Typical 9

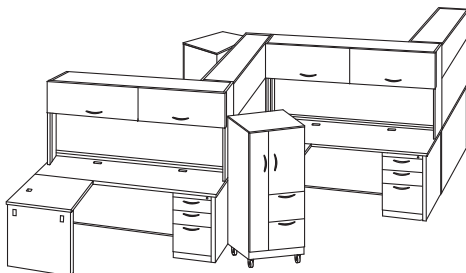

Overall Footprint: 144" deep x 216" wide

Included Elements	Qty	Product #	Price
Desk shell, no grommets, full mod., 30" D x 72" W	4	DK 3072 *F	\$5,696
Pedestal, b/b/f, 28" D x 15-1/4" W	4	EL? 3111	\$2,596
Return: with grommets, full mod., 24" D x 42" W	4	RT 2442 GF	\$3,476
Full hutch, loop pulls on doors, 13-5/8" D x 72" W	4	HGC 7202 L	\$7,736
Mobile cupboard tower, door on right, 23-1/2" D x 23-1/2" W	2	DG? J854	\$4,724
Total List Price:			\$24,228

How To Order: See page 2 for colors, laminates, fabrics

Product #	First "?" (drawer front style)	Product #	Second "?" (metal color)	Third "?" (laminates & edge)
BBS (Bare Bones Single)	A (Full Pull)	2 2454 (24"x54", f/f)	0683 (Muslin)	AWAW (Antique White)

Our objective is to offer you our absolute lowest cost desk: no frills, with only the bare necessities. If you'd prefer a desk with modesty panels, please see our desk shell.

Bare Bones Single Pedestal Desk



- One top with grommet (tops 60" or less = 1 grommet, 66" or more = 2 grommets)
- One pedestal with counterweight
- One panel leg with gusset
- No modesty panel
- Plastic wire management channel included with panel leg

H	D	W	Ped Depth	Drawer Options	Product #	Price
29	24	48	22	file/file	BBS ? 2 2448 ??	\$1,324
				box/box/file	BBS ? 3 2448 ??	\$1,361
29	24	54	22	file/file	BBS ? 2 2454 ??	\$1,367
				box/box/file	BBS ? 3 2454 ??	\$1,411
29	24	60	22	file/file	BBS ? 2 2460 ??	\$1,417
				box/box/file	BBS ? 3 2460 ??	\$1,456
29	24	66	22	file/file	BBS ? 2 2466 ??	\$1,468
				box/box/file	BBS ? 3 2466 ??	\$1,500
29	24	72	22	file/file	BBS ? 2 2472 ??	\$1,481
				box/box/file	BBS ? 3 2472 ??	\$1,525
29	30	48	28	file/file	BBS ? 2 3048 ??	\$1,537
				box/box/file	BBS ? 3 3048 ??	\$1,588
29	30	54	28	file/file	BBS ? 2 3054 ??	\$1,568
				box/box/file	BBS ? 3 3054 ??	\$1,619
29	30	60	28	file/file	BBS ? 2 3060 ??	\$1,607
				box/box/file	BBS ? 3 3060 ??	\$1,651
29	30	66	28	file/file	BBS ? 2 3066 ??	\$1,644
				box/box/file	BBS ? 3 3066 ??	\$1,676
29	30	72	28	file/file	BBS ? 2 3072 ??	\$1,694
				box/box/file	BBS ? 3 3072 ??	\$1,739

Bare Bones Double Pedestal Desk



- One top with grommet (tops 60" or less = 1 grommet, 66" or more = 2 grommets)
- Two pedestals with counterweight
- One file/file, one box/box/file
- No panel legs
- No modesty panel

H	D	W	Ped Depth	Drawer Options	Product #	Price
29	24	60	22	one each	BBD ? 5 2460 ??	\$1,432
29	24	66	22	one each	BBD ? 5 2466 ??	\$1,465
29	24	72	22	one each	BBD ? 5 2472 ??	\$1,497
29	30	60	28	one each	BBD ? 5 3060 ??	\$1,545
29	30	66	28	one each	BBD ? 5 3066 ??	\$1,574
29	30	72	28	one each	BBD ? 5 3072 ??	\$1,603

Bare Bones Single Pedestal Return

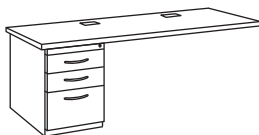

- One top with grommet (tops 60" or less = 1 grommet, 66" or more = 2 grommets)
- One pedestal with counterweight
- Two splice plates
- No panel legs
- No modesty panel

H	D	W	Ped Depth	Drawer Options	Product #	Price
29	24	30	22	file/file	BBR ? 2 2430 ??	\$797
				box/box/file	BBR ? 3 2430 ??	\$847
29	24	36	22	file/file	BBR ? 2 2436 ??	\$824
				box/box/file	BBR ? 3 2436 ??	\$874
29	24	42	22	file/file	BBR ? 2 2442 ??	\$873
				box/box/file	BBR ? 3 2442 ??	\$923
29	24	48	22	file/file	BBR ? 2 2448 ??	\$878
				box/box/file	BBR ? 3 2448 ??	\$928
29	24	60	22	file/file	BBR ? 2 2460 ??	\$932
				box/box/file	BBR ? 3 2460 ??	\$982
29	24	66	22	file/file	BBR ? 2 2466 ??	\$965
				box/box/file	BBR ? 3 2466 ??	\$1,015
29	24	72	22	file/file	BBR ? 2 2472 ??	\$997
				box/box/file	BBR ? 3 2472 ??	\$1,047

How To Order: See page 2 for colors, laminates, fabrics

Product #	First "?" (* = no grom, G= grom)	Modesty Panel (None, Partial, Full Modesty)	Second "?" (metal color)	Third "?" (laminate)
DK 2442 (Desk Shell, 24"x42")	G (Grommet in panel leg)	P (Partial height)	0683 (Muslin)	FMFM (Fusion Maple)

Desk Shell – No Modesty

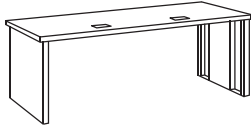

- One top with grommets (tops 60" or less = 1 center grommet, 66" or more = 2 grommets)
- Two panel legs (panel leg grommets optional, no up-charge)
- 36" work surfaces will include 29" panel legs, with 6" work surface overhang
- Two gussets (one per panel leg)
- No modesty panel
- Plastic wire management channels
- A gusset will prevent a mobile ped from sitting snugly against the panel leg
- Bow front work surfaces have a 6-1/2" overhang in the center

H	D	W	Product #	Price
29	24	30	DK 2430 ? N ??	\$944
29	24	36	DK 2436 ? N ??	\$970
29	24	42	DK 2442 ? N ??	\$1,020
29	24	48	DK 2448 ? N ??	\$1,033
29	24	54	DK 2454 ? N ??	\$1,058
29	24	60	DK 2460 ? N ??	\$1,096
29	24	66	DK 2466 ? N ??	\$1,153
29	24	72	DK 2472 ? N ??	\$1,171
29	30	30	DK 3030 ? N ??	\$1,072
29	30	36	DK 3036 ? N ??	\$1,072
29	30	42	DK 3042 ? N ??	\$1,116
29	30	48	DK 3048 ? N ??	\$1,134
29	30	54	DK 3054 ? N ??	\$1,178
29	30	60	DK 3060 ? N ??	\$1,217
29	30	66	DK 3066 ? N ??	\$1,254
29	30	72	DK 3072 ? N ??	\$1,304
29	36	48	DK 3648 ? N ??	\$1,254
29	36	60	DK 3660 ? N ??	\$1,298
29	36	66	DK 3666 ? N ??	\$1,374
29	36	72	DK 3672 ? N ??	\$1,424
29	36	72 (bow)	BD 3672 ? N ??	\$1,450

Desk Shell – Partial Modesty

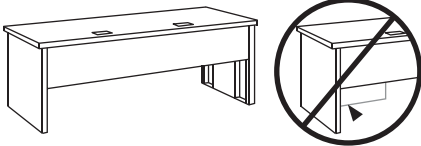

Hanging pedestals do not match the height of this modesty panel. Use 3/4 Modesty panel on next page.

- One top with grommets (tops 60" or less = 1 center grommet, 66" or more = 2 grommets)
- Two panel legs (panel leg grommets optional, no up-charge)
- 36" work surfaces will include 29" panel legs, with 6" work surface overhang
- Partial modesty panel is 12" tall, raised 17" from floor
- Modesty height designed to allow easy access to electrical outlets
- Plastic wire management channels
- Bow front work surfaces have a 6-1/2" overhang in the center

H	D	W	Product #	Price
29	24	30	DK 2430 ? P ??	\$958
29	24	36	DK 2436 ? P ??	\$989
29	24	42	DK 2442 ? P ??	\$1,052
29	24	48	DK 2448 ? P ??	\$1,066
29	24	54	DK 2454 ? P ??	\$1,115
29	24	60	DK 2460 ? P ??	\$1,146
29	24	66	DK 2466 ? P ??	\$1,204
29	24	72	DK 2472 ? P ??	\$1,229
29	30	30	DK 3030 ? P ??	\$1,091
29	30	36	DK 3036 ? P ??	\$1,097
29	30	42	DK 3042 ? P ??	\$1,140
29	30	48	DK 3048 ? P ??	\$1,165
29	30	54	DK 3054 ? P ??	\$1,210
29	30	60	DK 3060 ? P ??	\$1,260
29	30	66	DK 3066 ? P ??	\$1,310
29	30	72	DK 3072 ? P ??	\$1,361
29	36	48	DK 3648 ? P ??	\$1,291
29	36	60	DK 3660 ? P ??	\$1,362
29	36	66	DK 3666 ? P ??	\$1,424
29	36	72	DK 3672 ? P ??	\$1,481
29	36	72 (bow)	BD 3672 ? P ??	\$1,500

How To Order: See page 2 for colors, laminates, fabrics

Product #	First "?" (* = no grom, G= grom)	Modesty Panel (none, partial, full)	Second "?" (metal color)	Third "?" (laminated)
DK 2442 (Desk Shell, 24"x42")	G (Grommet in pan. leg)	F (Full height)	02Z8 (Cement)	FMFM (Fusion Maple)

Desk Shell – 3/4 Modesty

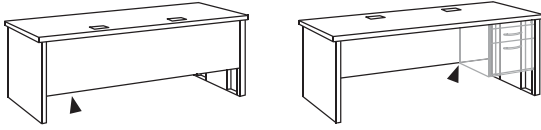

- 3/4 modesty bottom is even with hanging box/file ped
- One top with grommets
(tops 60" or less = 1 center grommet, 66" or more = 2 grommets)
- Two panel legs (panel leg grommets optional, no up-charge)
- Plastic wire management channels

H	D	W	Product #	Price
29	24	30	DK 2430 ? T ??	\$972
29	24	36	DK 2436 ? T ??	\$1,004
29	24	42	DK 2442 ? T ??	\$1,068
29	24	48	DK 2448 ? T ??	\$1,082
29	24	54	DK 2454 ? T ??	\$1,132
29	24	60	DK 2460 ? T ??	\$1,163
29	24	66	DK 2466 ? T ??	\$1,222
29	24	72	DK 2472 ? T ??	\$1,247
29	30	30	DK 3030 ? T ??	\$1,107
29	30	36	DK 3036 ? T ??	\$1,113
29	30	42	DK 3042 ? T ??	\$1,157
29	30	48	DK 3048 ? T ??	\$1,183
29	30	54	DK 3054 ? T ??	\$1,228
29	30	60	DK 3060 ? T ??	\$1,279
29	30	66	DK 3066 ? T ??	\$1,330
29	30	72	DK 3072 ? T ??	\$1,381

Desk Shell – Full Modesty

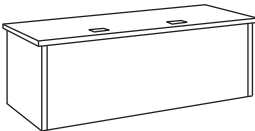

- One top with grommets
(tops 60" or less = 1 center grommet, 66" or more = 2 grommets)
- Two panel legs (panel leg grommets optional, no up-charge)
- 36" work surfaces will include 29" panel legs, with 6" work surface overhang
- Full height modesty panel is 27-5/8" tall, raised 1/2" from floor
- Plastic wire management channels
- Bow front work surfaces have a 6-1/2" overhang in the center

H	D	W	Product #	Price
29	24	30	DK 2430 ? F ??	\$983
29	24	36	DK 2436 ? F ??	\$1,021
29	24	42	DK 2442 ? F ??	\$1,090
29	24	48	DK 2448 ? F ??	\$1,109
29	24	54	DK 2454 ? F ??	\$1,141
29	24	60	DK 2460 ? F ??	\$1,190
29	24	66	DK 2466 ? F ??	\$1,261
29	24	72	DK 2472 ? F ??	\$1,291
29	30	30	DK 3030 ? F ??	\$1,116
29	30	36	DK 3036 ? F ??	\$1,128
29	30	42	DK 3042 ? F ??	\$1,178
29	30	48	DK 3048 ? F ??	\$1,210
29	30	54	DK 3054 ? F ??	\$1,248
29	30	60	DK 3060 ? F ??	\$1,310
29	30	66	DK 3066 ? F ??	\$1,361
29	30	72	DK 3072 ? F ??	\$1,424
29	36	48	DK 3648 ? F ??	\$1,330
29	36	60	DK 3660 ? F ??	\$1,399
29	36	66	DK 3666 ? F ??	\$1,487
29	36	72	DK 3672 ? F ??	\$1,544
29	36	72 (bow)	BD 3672 ? F ??	\$1,570

Optional Panel Leg Grommets
(covers sold separately)

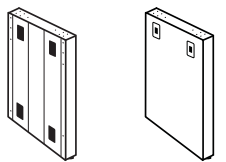

inside view
(covers shown)

outside view

SINGLE & DOUBLE PEDESTAL DESKS

SIN 711-2

When adding a return, bridge, or peninsula to a single pedestal desk (L-Station), the single pedestal desk should be at least 66" wide to leave adequate knee space.

How To Order: See page 2 for colors, laminates, fabrics

Product #	First "?" (drawer front style)	Product #	Second "?" (metal color)
EL (Pedestal)	A (full pull)	3009 (WSS Ped, 21 7/8" f/f)	0073 (Cloud)

Order Pedestals Separately to Create Single or Double Pedestal Desks or Credenzas

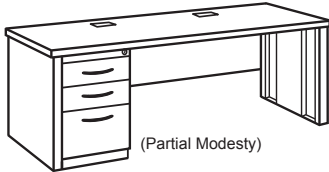

Sample Pedestal Desk
24" x 66" desk shell DK 2466 * P
22" dp wss pedestal EL S 3011

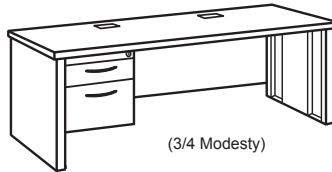

Sample Hanging Pedestal Desk
24" x 66" desk shell DK 2466 * T
22" dp hanging pedestal EL S 0603

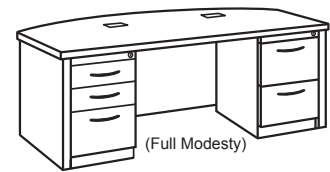

Sample Double Pedestal Desk
36" x 72" bow front desk shell BD 3672 F
28" dp wss pedestal ELS 3111
28" dp wss pedestal ELS 3109

Below is a sampling of storage commonly used under desk work surfaces. See our Trace Storage Price Book for more options.

TRACE Work Surface Supporting Pedestal

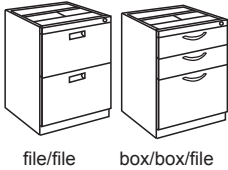

- UM Series lock
- Full extension steel ball-bearing slides
- Leveling glides with 1-5/8" adjustment
- A 27-7/8" deep ped will not fit under a 24" work surface
- No counterweight is necessary because two panel legs are present

H	D	W	Pkg Wt	Pkg Cube	Drawer Options	Product #	Price
27-3/4	17-7/8	15-1/4	51 lb	7.2 ft	file/file	EL ? 2909 ?	\$539
			53 lb	7.2 ft	box/box/file	EL ? 2911 ?	\$585
27-3/4	21-7/8	15-1/4	56 lb	8.6 ft	file/file	EL ? 3009 ?	\$545
			59 lb	8.6 ft	box/box/file	EL ? 3011 ?	\$596
27-3/4	27-7/8	15-1/4	67 lb	10.6 ft	file/file	EL ? 3109 ?	\$620
			70 lb	10.6 ft	box/box/file	EL ? 3111 ?	\$649

Available Fronts | A | B | D | F | H | I | N | P | Q | S | Y

TRACE Freestanding Pedestal

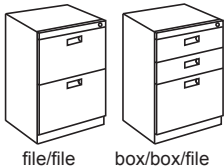

- Stationary pedestal includes counterweight

H	D	W	Pkg Wt	Pkg Cube	Drawer Options	Product #	Price
27-3/4	18-7/8	15-1/4	68 lb	7.6 ft	file/file	EL ? 6109 ?	\$551
			70 lb	7.6 ft	box/box/file	EL ? 6111 ?	\$599
27-3/4	21-7/8	15-1/4	74 lb	8.6 ft	file/file	EL ? 5109 ?	\$566
			76 lb	8.6 ft	box/box/file	EL ? 5111 ?	\$617
27-3/4	27-7/8	15-1/4	83 lb	10.6 ft	file/file	EL ? 5309 ?	\$637
			86 lb	10.6 ft	box/box/file	EL ? 5311 ?	\$691

Available Fronts | A | B | D | F | H | I | N | P | Q | S | Y

TRACE Hanging Pedestal



- Full extension steel ball-bearing slides
- Quick-mount system for easy installation
- Cannot be used with "no modesty panel" desk shell, because a hanging pedestal does not provide floor support and it interferes with gusset attachment.

H	D	W	Pkg Wt	Pkg Cube	Drawer Options	Product #	Price
19-3/8	17-7/8	15-1/4	40 lb	5.3 ft	box/file	EL ? 0503 ?	\$395
19-3/8	21-7/8	15-1/4	43 lb	5.3 ft	box/file	EL ? 0603 ?	\$406
25	21-7/8	15-1/4	52 lb	8.6 ft	file/file	EL ? 1209 ?	\$540
25	21-7/8	15-1/4	52 lb	8.6 ft	box/box/file	EL ? 1211 ?	\$590

Available Fronts | A | B | D | F | H | I | N | P | Q | S | Y

TRACE Work Surface Supporting Lateral File



- Standard TRACE lateral file without top
- Standard depth: 18-1/4"
- Top channels designed to mount underwork surface
- Safety interlock is included
- Counterweight is not required if installed beneath a desk work surface

H	D	W	Pkg Wt	Pkg Cube	Drawer Options	Product #	Price
27-3/4	18-1/4	30	80 lb	11.8 ft	box/file	RG ? C301 ? NT	\$857
27-3/4	18-1/4	36	102 lb	14.0 ft	box/file	RG ? C401 ? NT	\$916
27-3/4	18-1/4	42	115 lb	16.2 ft	file/file	RG ? C501 ? NT	\$1,001

Available Fronts | A | B | ~~D~~ | F | H | ~~I~~ | ~~N~~ | P | Q | S | Y

How To Order: See page 2 for colors, laminates, fabrics

Product #	First "?" (* = no grom, G=grom)	Modesty Panel (none, partial, full)	Second "?" (metal color)	Third "?" (laminate)
RT 3030 (Return Shell, 30"x30")	G (Grommet in pan. leg)	P (Partial height)	0257 (Light Grey)	BNBN (Beige Nebula)

When adding a return, bridge, or peninsula to a single pedestal desk (L-Station), the single pedestal should be at least 66" wide to leave adequate knee space.

Return Shell – No Modesty

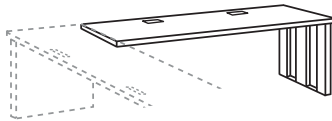

- One top with grommets
(tops 60" or less = 1 center grommet, 66" or more = 2 grommets)
- One panel leg (panel leg grommets optional, no up-charge)
- No modesty panel
- Two splice plates
- One gusset
- Plastic wire management channel
- Non-handed

Return Shell – Partial Modesty

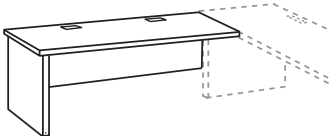

- One top with grommets
(tops 60" or less = 1 center grommet, 66" or more = 2 grommets)
- One panel leg (panel leg grommets optional, no up-charge)
- Partial modesty is 12" tall, raised 17" from the floor
- Two splice plates
- Modesty panel
- Modesty panel offset brackets
- Plastic wire management channel
- Non-handed

Return Shell – Full Modesty

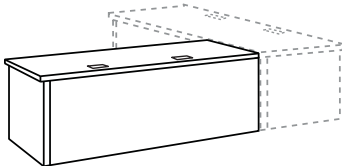

- One top with grommets
(tops 60" or less = 1 center grommet, 66" or more = 2 grommets)
- One panel leg (panel leg grommets optional, no up-charge)
- Full modesty is 27-5/8" tall, raised 1/2" from the floor
- Two splice plates
- Modesty panel offset brackets
- Plastic wire management channel
- Non-handed

Optional Panel Leg Grommets
(covers sold separately)

inside view
(covers shown)

outside view

H	D	W	Product #	Price
29	24	24	RT 2424 ? N ??	\$703
29	24	30	RT 2430 ? N ??	\$719
29	24	36	RT 2436 ? N ??	\$750
29	24	42	RT 2442 ? N ??	\$800
29	24	48	RT 2448 ? N ??	\$808
29	24	54	RT 2454 ? N ??	\$823
29	24	60	RT 2460 ? N ??	\$870
29	24	66	RT 2466 ? N ??	\$926
29	24	72	RT 2472 ? N ??	\$952
29	30	30	RT 3030 ? N ??	\$832
29	30	36	RT 3036 ? N ??	\$832
29	30	42	RT 3042 ? N ??	\$869
29	30	48	RT 3048 ? N ??	\$894
29	30	54	RT 3054 ? N ??	\$932
29	30	60	RT 3060 ? N ??	\$970
29	30	66	RT 3066 ? N ??	\$1,008
29	30	72	RT 3072 ? N ??	\$1,058

H	D	W	Product #	Price
29	24	24	RT 2424 ? P ??	\$718
29	24	30	RT 2430 ? P ??	\$738
29	24	36	RT 2436 ? P ??	\$775
29	24	42	RT 2442 ? P ??	\$832
29	24	48	RT 2448 ? P ??	\$845
29	24	54	RT 2454 ? P ??	\$873
29	24	60	RT 2460 ? P ??	\$901
29	24	66	RT 2466 ? P ??	\$965
29	24	72	RT 2472 ? P ??	\$990
29	30	30	RT 3030 ? P ??	\$851
29	30	36	RT 3036 ? P ??	\$857
29	30	42	RT 3042 ? P ??	\$901
29	30	48	RT 3048 ? P ??	\$920
29	30	54	RT 3054 ? P ??	\$968
29	30	60	RT 3060 ? P ??	\$1,015
29	30	66	RT 3066 ? P ??	\$1,052
29	30	72	RT 3072 ? P ??	\$1,109

H	D	W	Product #	Price
29	24	24	RT 2424 ? F ??	\$749
29	24	30	RT 2430 ? F ??	\$768
29	24	36	RT 2436 ? F ??	\$806
29	24	42	RT 2442 ? F ??	\$869
29	24	48	RT 2448 ? F ??	\$889
29	24	54	RT 2454 ? F ??	\$933
29	24	60	RT 2460 ? F ??	\$977
29	24	66	RT 2466 ? F ??	\$1,046
29	24	72	RT 2472 ? F ??	\$1,078
29	30	30	RT 3030 ? F ??	\$876
29	30	36	RT 3036 ? F ??	\$889
29	30	42	RT 3042 ? F ??	\$938
29	30	48	RT 3048 ? F ??	\$977
29	30	54	RT 3054 ? F ??	\$1,027
29	30	60	RT 3060 ? F ??	\$1,078
29	30	66	RT 3066 ? F ??	\$1,122
29	30	72	RT 3072 ? F ??	\$1,184

“D” & “P” PENINSULAS

SIN 711-2

When adding a return, bridge, or peninsula to a single ped desk (L-Station), the single ped desk should be at least 66" wide to leave adequate knee space. Peninsulas are not freestanding units; they must attach to bridge, desk shell, or return.

How To Order: See page 2 for colors, laminates, fabrics

Product #	First "?" (* = no grom, G= grom)	Modesty Panel (none, partial, full)	Second "?" (metal color)	Third "?" (laminates)
PNR 3060 (P Right Pen 30"x60")	*	N (No modesty panel)	0257 (Light Grey)	BNBN (Beige Nebula)

“D” & “P” Peninsula – No Modesty

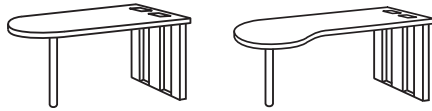

- One top with grommets
- One post leg
- One panel leg (panel leg grommets optional, no up-charge)
- One gusset
- No modesty panel
- Plastic wire management channel

H	A	B	C	Top Shape	Product #	Price
29	30	60	30	"D"	PD 3060 ? N ??	\$1,128
29	30	66	30	"D"	PD 3066 ? N ??	\$1,229
29	30	72	30	"D"	PD 3072 ? N ??	\$1,235
29	30	60	36	"P" left	PNL 3060 ? N ??	\$1,525
29	30	66	36	"P" left	PNL 3066 ? N ??	\$1,619
29	30	72	36	"P" left	PNL 3072 ? N ??	\$1,626
29	30	60	36	"P" right	PNR 3060 ? N ??	\$1,525
29	30	66	36	"P" right	PNR 3066 ? N ??	\$1,619
29	30	72	36	"P" right	PNR 3072 ? N ??	\$1,626

“D” & “P” Peninsula – Partial Modesty

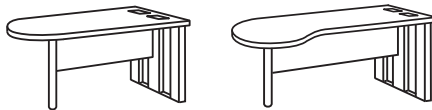

- One top with grommets
- One post leg
- One panel leg (panel leg grommets optional, no up-charge)
- Partial height modesty panel is 12" tall, raised 17" from floor
- Plastic wire management channel

H	A	B	C	Top Shape	Product #	Price
29	30	60	30	"D"	PD 3060 ? P ??	\$1,204
29	30	66	30	"D"	PD 3066 ? P ??	\$1,304
29	30	72	30	"D"	PD 3072 ? P ??	\$1,322
29	30	60	36	"P" left	PNL 3060 ? P ??	\$1,601
29	30	66	36	"P" left	PNL 3066 ? P ??	\$1,694
29	30	72	36	"P" left	PNL 3072 ? P ??	\$1,708
29	30	60	36	"P" right	PNR 3060 ? P ??	\$1,601
29	30	66	36	"P" right	PNR 3066 ? P ??	\$1,694
29	30	72	36	"P" right	PNR 3072 ? P ??	\$1,708

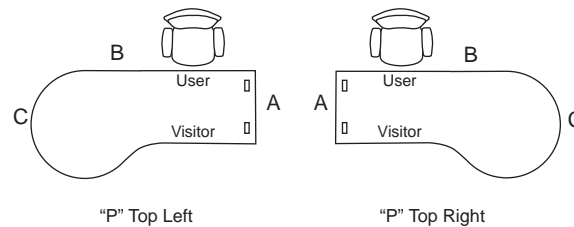
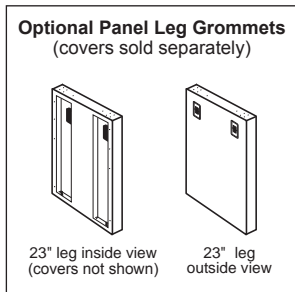

How To Order: See page 2 for colors, laminates, fabrics

A corner may not be used as a stand-alone or end-of-run desk; it must be attached on both sides to a bridge or return.

Product #	Modesty Panel (none, partial, full)	Second "?" (metal color)	Third "?" (laminate)
CC 2436 (Corner curved, 24"x36")	N (No modesty panel)	0257 (Light Grey)	BNBN (Beige Nebula)

Corner – No Modesty

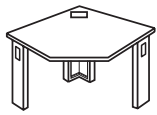

Straight Edge



Curved Edge

- One top with grommet
- One corner leg
- Two 12" panel legs include grommet and panel leg covers
- No modesty panels
- Plastic wire management channels

H	A	B	User Edge	Product #	Price
29	24	36	straight	CS 2436 N ??	\$1,367
29	24	42	straight	CS 2442 N ??	\$1,524
29	24	48	straight	CS 2448 N ??	\$1,543
29	24	36	curved	CC 2436 N ??	\$1,367
29	24	42	curved	CC 2442 N ??	\$1,524
29	24	48	curved	CC 2448 N ??	\$1,543

Corner – Partial Modesty

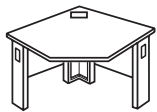

Straight Edge



Curved Edge

- One top with grommet
- One corner leg
- Two 12" panel legs include grommet and panel leg covers
- Partial height modesty panels are 12" tall, raised 17" from the floor
- Plastic wire management channels

H	A	B	User Edge	Product #	Price
29	24	36	straight	CS 2436 P ??	\$1,582
29	24	42	straight	CS 2442 P ??	\$1,745
29	24	48	straight	CS 2448 P ??	\$1,777
29	24	36	curved	CC 2436 P ??	\$1,582
29	24	42	curved	CC 2442 P ??	\$1,745
29	24	48	curved	CC 2448 P ??	\$1,777

Corner – Full Modesty

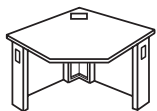

Straight Edge

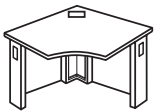

Curved Edge

- One top with grommet
- One corner leg
- Two 12" panel legs include grommet and panel leg covers
- Full height modesty panels are 27-5/8" tall, raised 1/2" from the floor
- Plastic wire management channels

H	A	B	User Edge	Product #	Price
29	24	36	straight	CS 2436 F ??	\$1,632
29	24	42	straight	CS 2442 F ??	\$1,808
29	24	48	straight	CS 2448 F ??	\$1,853
29	24	36	curved	CC 2436 F ??	\$1,632
29	24	42	curved	CC 2442 F ??	\$1,808
29	24	48	curved	CC 2448 F ??	\$1,853

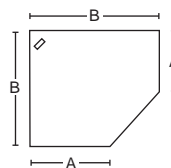

Corner Straight

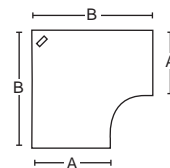

Corner Curved

Corner Leg Wire Management Cover

- Metal cover closes out the triangular corner legs to safely enclose cables. Magnetic attachment allows for easy removal and replacement
- Please specify color

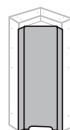

Product	Qty	Product #	Price
Corner Leg Cover (Specify Color)	Pkg. of 1 cover	GOC 151 K ?	\$56

EXTENDED CORNERS

SIN 711-2

An extended corner that does not include an end-of-run 24" or 30" deep panel leg (see next page) may not be used as a stand-alone desk, it must be attached to a bridge or return on both sides. For end-of-run applications, see the following page.

How To Order: See page 2 for colors, laminates, fabrics					
Product #	L/R (Corner left or right)	Product #	Modesty Panel (none, partial, full)	First "?" (Metal color)	Second "?" (laminates)
ET (Extended Corner)	L (Ext Corner left)	246024 (24"x60"x24")	P (Partial height)	0257 (Light Grey)	BNBN (Beige Nebula)

Extended Corner – No Modesty

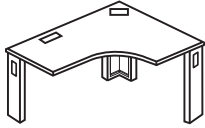

- One top with grommet
- One corner leg, two 12" panel legs
- Two 12" panel legs include grommet and panel leg covers
- No modesty panels
- Plastic wire management channels

H	A	B	C	D	Product #	L/R	Product #	Price
29	24	48	60	24	ET	L/R	24 60 24 N ??	\$1,902
29	24	48	66	24	ET	L/R	24 66 24 N ??	\$1,945
29	24	48	72	24	ET	L/R	24 72 24 N ??	\$2,016
29	24	48	60	30	ET	L/R	24 60 30 N ??	\$1,902
29	24	48	66	30	ET	L/R	24 66 30 N ??	\$1,945
29	24	48	72	30	ET	L/R	24 72 30 N ??	\$2,016
29	30	48	60	24	ET	L/R	30 60 24 N ??	\$1,902
29	30	48	66	24	ET	L/R	30 66 24 N ??	\$1,945
29	30	48	72	24	ET	L/R	30 72 24 N ??	\$2,016
29	30	48	60	30	ET	L/R	30 60 30 N ??	\$1,902
29	30	48	66	30	ET	L/R	30 66 30 N ??	\$1,945
29	30	48	72	30	ET	L/R	30 72 30 N ??	\$2,016

Extended Corner – Partial Modesty

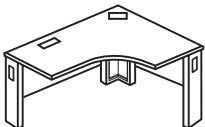

- One top with grommet
- One corner leg, two 12" panel legs
- Two 12" panel legs include grommet and panel leg covers
- Partial height modesty panels are 12" tall, raised 17" from floor
- Plastic wire management channels

H	A	B	C	D	Product #	L/R	Product #	Price
29	24	48	60	24	ET	L/R	24 60 24 P ??	\$2,142
29	24	48	66	24	ET	L/R	24 66 24 P ??	\$2,201
29	24	48	72	24	ET	L/R	24 72 24 P ??	\$2,268
29	24	48	60	30	ET	L/R	24 60 30 P ??	\$2,142
29	24	48	66	30	ET	L/R	24 66 30 P ??	\$2,201
29	24	48	72	30	ET	L/R	24 72 30 P ??	\$2,268
29	30	48	60	24	ET	L/R	30 60 24 P ??	\$2,142
29	30	48	66	24	ET	L/R	30 66 24 P ??	\$2,201
29	30	48	72	24	ET	L/R	30 72 24 P ??	\$2,268
29	30	48	60	30	ET	L/R	30 60 30 P ??	\$2,142
29	30	48	66	30	ET	L/R	30 66 30 P ??	\$2,201
29	30	48	72	30	ET	L/R	30 72 30 P ??	\$2,268

Extended Corner – Full Modesty

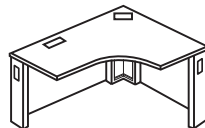

- One top with grommet
- One corner leg, two 12" panel legs
- Two 12" panel legs include grommet and panel leg covers
- Full height modesty panels are 27-5/8" tall, raised 1/2" from floor
- Plastic wire management channels

H	A	B	C	D	Product #	L/R	Product #	Price
29	24	48	60	24	ET	L/R	24 60 24 F ??	\$2,230
29	24	48	66	24	ET	L/R	24 66 24 F ??	\$2,299
29	24	48	72	24	ET	L/R	24 72 24 F ??	\$2,369
29	24	48	60	30	ET	L/R	24 60 30 F ??	\$2,230
29	24	48	66	30	ET	L/R	24 66 30 F ??	\$2,299
29	24	48	72	30	ET	L/R	24 72 30 F ??	\$2,369
29	30	48	60	24	ET	L/R	30 60 24 F ??	\$2,230
29	30	48	66	24	ET	L/R	30 66 24 F ??	\$2,299
29	30	48	72	24	ET	L/R	30 72 24 F ??	\$2,369
29	30	48	60	30	ET	L/R	30 60 30 F ??	\$2,230
29	30	48	66	30	ET	L/R	30 66 30 F ??	\$2,299
29	30	48	72	30	ET	L/R	30 72 30 F ??	\$2,369

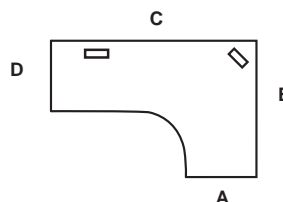

Extended Corner Left Desktop

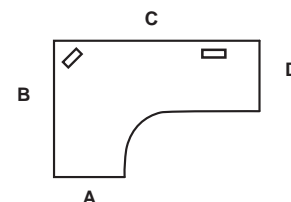

Extended Corner Right Desktop

How To Order: See page 2 for colors, laminates, fabrics

An end-of-run may be used as an end run, it must be attached to a bridge or return on the side with the 12" panel leg.

Product #	L/R (Corner left or right)	Product #	Modesty Panel (none, partial, full)	First "?" (Metal color)	Second "?" (Laminate)
ED (Extended Corner)	L (Ext Corner left)	246024 (24"x60"x24")	P (Partial height)	0257 (Light Grey)	BNBN (Beige Nebula)

End-of-Run Extended Corner - No Modesty

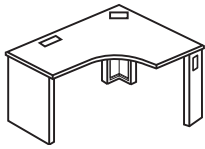

End-of-run corners are designed with a 23" or 29" panel leg located on the "D" side of the corner desk. This panel allows desking runs to be terminated at the corner in a way that ensures stability and offers a clean, finished look.

- One top with grommet
- One corner leg, one 12" panel leg, and one 23" or 29" panel leg
- No modesty panels
- Plastic wire management channels
- One gusset

H	A	B	C	D	Product #	L/R	Product #	Price
29	24	48	60	24	ED	L/R	24 60 24 N ??	\$2,042
29	24	48	66	24	ED	L/R	24 66 24 N ??	\$2,090
29	24	48	72	24	ED	L/R	24 72 24 N ??	\$2,144
29	24	48	60	30	ED	L/R	24 60 30 N ??	\$2,056
29	24	48	66	30	ED	L/R	24 66 30 N ??	\$2,121
29	24	48	72	30	ED	L/R	24 72 30 N ??	\$2,163
29	30	48	60	24	ED	L/R	30 60 24 N ??	\$2,056
29	30	48	60	24	ED	L/R	30 66 24 N ??	\$2,116
29	30	48	72	24	ED	L/R	30 72 24 N ??	\$2,162
29	30	48	60	30	ED	L/R	30 60 30 N ??	\$2,074
29	30	48	66	30	ED	L/R	30 66 30 N ??	\$2,147
29	30	48	72	30	ED	L/R	30 72 30 N ??	\$2,179

End-of-Run Extended Corner - Partial Modesty

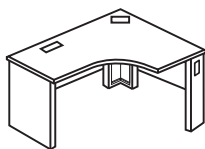

- One top with grommet
- One corner leg, one 12" panel leg, and one 23" or 29" panel leg
- Partial height modesty panels are 12" tall, raised 17" from floor
- Plastic wire management channels

H	A	B	C	D	Product #	L/R	Product #	Price
29	24	48	60	24	ED	L/R	24 60 24 P ??	\$2,280
29	24	48	60	24	ED	L/R	24 66 24 P ??	\$2,338
29	24	48	72	24	ED	L/R	24 72 24 P ??	\$2,397
29	24	48	60	30	ED	L/R	24 60 30 P ??	\$2,296
29	24	48	66	30	ED	L/R	24 66 30 P ??	\$2,354
29	24	48	72	30	ED	L/R	24 72 30 P ??	\$2,414
29	30	48	60	24	ED	L/R	30 60 24 P ??	\$2,280
29	30	48	66	24	ED	L/R	30 66 24 P ??	\$2,367
29	30	48	72	24	ED	L/R	30 72 24 P ??	\$2,397
29	30	48	60	30	ED	L/R	30 60 30 P ??	\$2,296
29	30	48	66	30	ED	L/R	30 66 30 P ??	\$2,384
29	30	48	72	30	ED	L/R	30 72 30 P ??	\$2,413

End-of-Run Extended Corner - Full Modesty

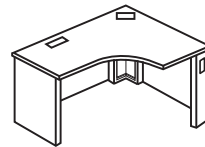

- One top with grommet
- One corner leg, one 12" panel leg, and one 23" or 29" panel leg
- Full height modesty panels are 27-5/8" tall, raised 1/2" from floor
- Plastic wire management channels

H	A	B	C	D	Product #	L/R	Product #	Price
29	24	48	60	24	ED	L/R	24 60 24 F ??	\$2,369
29	24	48	66	24	ED	L/R	24 66 24 F ??	\$2,433
29	24	48	72	24	ED	L/R	24 72 24 F ??	\$2,505
29	24	48	60	30	ED	L/R	24 60 30 F ??	\$2,386
29	24	48	66	30	ED	L/R	24 66 30 F ??	\$2,462
29	24	48	72	30	ED	L/R	24 72 30 F ??	\$2,522
29	30	48	60	24	ED	L/R	30 60 24 F ??	\$2,369
29	30	48	66	24	ED	L/R	30 66 24 F ??	\$2,433
29	30	48	72	24	ED	L/R	30 72 24 F ??	\$2,505
29	30	48	60	30	ED	L/R	30 60 30 F ??	\$2,386
29	30	48	66	30	ED	L/R	30 66 30 F ??	\$2,454
29	30	48	72	30	ED	L/R	30 72 30 F ??	\$2,522

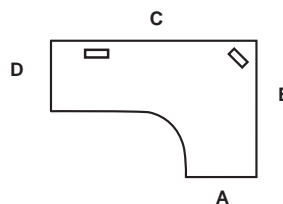

Extended Corner Left Desktop

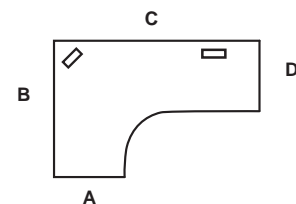

Extended Corner Right Desktop

Bridges attach to desk shells, single pedestal desks, corner desks, and peninsulas to form a U-shaped configuration. Bridges cannot attach to returns or single pedestal returns. When adding a bridge to a single pedestal desk (L-Station), the single pedestal desk should be at least 66" wide to leave adequate knee space.

How To Order: See page 2 for colors, laminates, fabrics

Product #	Modesty Panel (none, partial, full)	First "?" (laminate)
BR 2436 (Bridge, 24"x36")	F (Full Height)	WCWC (Wild Cherry)

Bridge – No Modesty

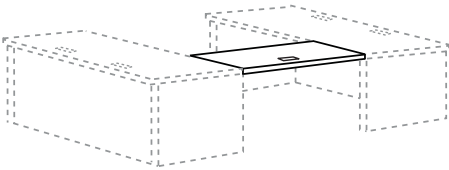

- One top with grommet
(tops 60" or less = 1 center grommet, 66" or more = 2 grommets)
- Four splice plates
- No modesty panels

H	D	W	Product #	Price
29	24	24	BR 2424 N ?	\$391
29	24	30	BR 2430 N ?	\$409
29	24	36	BR 2436 N ?	\$434
29	24	42	BR 2442 N ?	\$491
29	24	48	BR 2448 N ?	\$498
29	24	60	BR 2460 N ?	\$560
29	24	66	BR 2466 N ?	\$618
29	24	72	BR 2472 N ?	\$642

Bridge – Partial Modesty

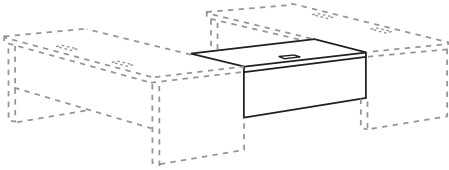

- One top with grommet
(tops 60" or less = 1 center grommet, 66" or more = 2 grommets)
- Four splice plates
- Partial height modesty panels are 12" tall, raised 17" from floor
- Modesty panel offset brackets

H	D	W	Product #	Price
29	24	24	BR 2424 P ? ?	\$523
29	24	30	BR 2430 P ? ?	\$548
29	24	36	BR 2436 P ? ?	\$580
29	24	42	BR 2442 P ? ?	\$636
29	24	48	BR 2448 P ? ?	\$649
29	24	60	BR 2460 P ? ?	\$725
29	24	66	BR 2466 P ? ?	\$788
29	24	72	BR 2472 P ? ?	\$812

Bridge – Full Modesty

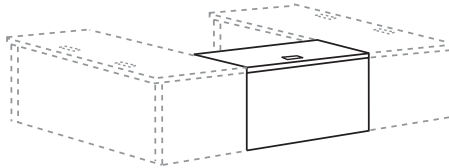

- One top with grommet
(tops 60" or less = 1 center grommet, 66" or more = 2 grommets)
- Four splice plates
- Full height modesty panels are 27-5/8" tall, raised 1/2" from floor
- Modesty panel offset brackets

H	D	W	Product #	Price
29	24	24	BR 2424 F ? ?	\$548
29	24	30	BR 2430 F ? ?	\$574
29	24	36	BR 2436 F ? ?	\$611
29	24	42	BR 2442 F ? ?	\$680
29	24	48	BR 2448 F ? ?	\$700
29	24	60	BR 2460 F ? ?	\$781
29	24	66	BR 2466 F ? ?	\$851
29	24	72	BR 2472 F ? ?	\$882

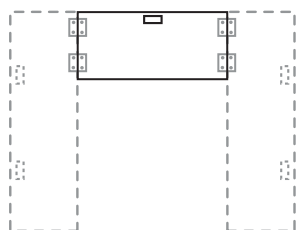

How To Order: See page 2 for colors, laminates, fabrics

Product #	First "?" (* = no loop, L= loop pull)	Second "?" (metal color)
HGC 3602 (Desk Hutch)	*	0257 (Light Grey)
	(No loop pull on doors)	

Ordering COM fabric?

See the Specification Guide located in the front of this book

Desk Hutch

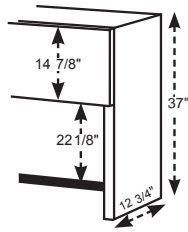
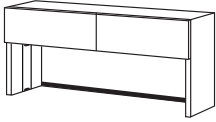

H	D	W	Pkg Wt	Pkg Cube	Product #	Price
37	13-5/8	36	60 lb	13.3 ft	HGC 3602 ???	\$1,688
37	13-5/8	42	66 lb	15.4 ft	HGC 4202 ???	\$1,727
37	13-5/8	48	75 lb	17.5 ft	HGC 4802 ???	\$1,764
37	13-5/8	54	81 lb	19.6 ft	HGC 5402 ???	\$1,805
37	13-5/8	60	87 lb	21.7 ft	HGC 6002 ???	\$1,843
37	13-5/8	66	93 lb	23.8 ft	HGC 6602 ???	\$1,879
37	13-5/8	72	99 lb	25.9 ft	HGC 7202 ???	\$1,934

- Doors flip up to stow over the top, hutch compartment includes a vertical center divider
- 36" and 42" wide hutches include one door, all others include two doors
- Inside depth is 12-1/2" and inside height is 12-1/4"
- Out-of-sight locks are located beneath shelf, and the two doors are keyed alike
- Includes UM series locks - also available in LL. SL locks are not available
- Includes tack board and rubber wire management strip
- Bottom shelf accommodates a task light (sold separately)
- To add a loop pull (S:Satin Nickel Loop) to hutch doors, add an "L" as a suffix to the product number (no up-charge)
- Removable metal wire management covers on hutch side panels conceal task light cord
- Hutch upright side panels must be placed within 2" of a pedestal, panel leg, or corner leg to ensure adequate support
- Hutch width is actually 1" narrower than listed, to allow for 1/2" setback on both sides
- Hutch ships fully assembled

Wall-Mounted Overhead – Horizontal Bracket Over-the-Top Stowing Door

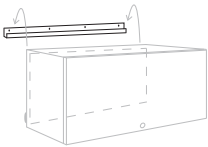

H	D	W	Pkg Wt	Pkg Cube	Product #	Price
15	13-3/4	24	29 lb	2.1 ft	OGO 2430 ? J ?	\$431
15	13-3/4	30	33 lb	2.1 ft	OGO 3030 ? J ?	\$436
15	13-3/4	36	36 lb	2.1 ft	OGO 3630 ? J ?	\$472
15	13-3/4	42	41 lb	2.6 ft	OGO 4230 ? J ?	\$487
15	13-3/4	48	45 lb	2.6 ft	OGO 4830 ? J ?	\$528
15	13-3/4	54	50 lb	3.2 ft	OGO 5430 ? J ?	\$585
15	13-3/4	60	56 lb	3.2 ft	OGO 6030 ? J ?	\$620

- Single bracket mounts horizontally on wall, anchored to wall studs
- Cabinet features over-the-top stowing door
- Includes cabinet, horizontal bracket, and fasteners
- To add a loop pull (S:Satin Nickel Loop) to hutch doors, add an "L" as a suffix to the product number (no up-charge)
- Ships KD, to be assembled at work site
- All overhead brackets, whether wall-mounted or panel-mounted, include anti-dislodgement features to prevent the unit from dislodging when pushed or struck from below
- It is the exclusively the responsibility of the installer to ensure that panels and wall-mounted brackets are properly and safely anchored
- Overhead cabinet end panels consist of 16 gauge steel, shelves and tops are 18 gauge steel, doors are 20 gauge steel
- Shelf weight restrictions are as follows:
 - 24" overhead: 60 lbs
 - 30" overhead: 75 lbs
 - 36" overhead: 90 lbs
 - 42" overhead: 105 lbs
 - 48" overhead: 120 lbs
 - 54" overhead: 130 lbs
 - 60" overhead: 150 lbs

To add a satin nickel handle to overhead front, add an "L" suffix to the part number (no up-charge).

Wall-Mounted Tack Board

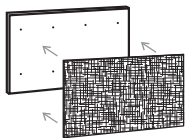

H	D	W	Pkg Wt	Pkg Cube	Product #	Price
20	1	24	10 lb	.8 ft	TBM24 ??	\$301
20	1	30	12 lb	.8 ft	TBM30 ??	\$333
20	1	36	13 lb	.9 ft	TBM36 ??	\$373
20	1	42	14 lb	.9 ft	TBM42 ??	\$396
20	1	48	14 lb	1.0 ft	TBM48 ??	\$432
20	1	54	15 lb	1.0 ft	TBM54 ??	\$460
20	1	60	15 lb	1.2 ft	TBM60 ??	\$497

- Tack board sits inside metal back panel, similar to desk hutch tack board
- Metal back panel attaches to wall studs
- Includes metal back panel, tack board, and fasteners
- Specify metal color and fabric

Ordering COM fabric?

See the Specification Guide located in the front of this book

How To Order: See page 2 for colors, laminates, fabrics			
Product #	First "?" (metal color)	Second "?" (laminates)	Third "?" (Tack board fabric)
TAC 66 (66" Transaction Counter)	0257 (Light Grey)	TTPT (Titanium/Plat.)	7K (Navy)

TRACE File Hutch

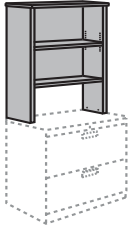

- Designed to set on laminate work surface, typically on top of a lateral file or double door
- Depth and height matches TRACE desk hutch
- Side panels attach to laminate top, fasteners included
- Back panel extends from bottom of fixed shelf to file hutch top
- One fixed shelf 12" from bottom, one adjustable shelf
- Ships assembled
- Widths match lateral file widths

H	D	W	Pkg Wt	Pkg Cube	Product #	Price
37	12-3/4	30	51 lb	10.6 ft	FLN 3012 ?	\$568
37	12-3/4	36	60 lb	12.6 ft	FLN 3612 ?	\$590
37	12-3/4	42	72 lb	14.6 ft	FLN 4212 ?	\$606

Magnetic Shelf Divider

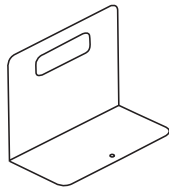

- Black magnetic dividers are 7.5" tall and 8" wide, with a 4" base. Magnet is 7-7/8" x 3"
- Appropriate for use on any lateral file drawer or shelf, bookcase, desk hutch, double door storage cabinet, overhead storage cabinet or overhead shelf

Package	Pkg Wt	Pkg Cube	Product #	Price
(package of 3)	4.0 lb	2 ft	LFM 300 30	\$50

Transaction Counter

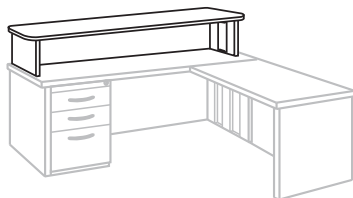

- Laminate top is 14" deep, with 3/4" overhang on the visitor side and 1/2" overhang on the user side
- Metal sides and back panel are 1" narrower than listed, to allow for 1/2" set-back on both sides
- Tack board included inside back panel is similar to the desk hutch, but with no rubber wire management strip
- Storage space underneath counter is 12-3/4" deep and 13-3/4" high
- Inner side panels include vertical inserts to conceal work surface fasteners
- Ships KD for easy assembly at the work site (laminates top will ship in one package, metal sides and tack board will ship in a second package)

H	D	W	Pkg Wt	Pkg Cube	Product #	Price
15	14	48	22 lb	2.6 ft	TAC 48 ???	\$680
15	14	60	25 lb	3.2 ft	TAC 60 ???	\$756
15	14	66	28 lb	3.5 ft	TAC 66 ???	\$806
15	14	72	31 lb	3.8 ft	TAC 72 ???	\$826

How To Order: See page 2 for colors, laminates, fabrics

Ordering COM fabric?

See the Specification Guide located in the front of this book

Product #	First "?" (Tack board fabric)
PSR 24 (Rectangular Screen 23" Wide)	D1 (Abergine)

Tackable Screen - Rectangular

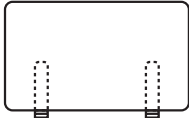

Dotted lines indicate hidden mounting brackets

- Tackable board is covered on both sides with fabric of your choice. Brackets and fasteners are included, which allow the screen to be fastened to the underside of the work surface
- 12 gauge metal mounting brackets slide between these back-to-back tackable boards and are hidden from sight (See cut-away diagram below)
- Please note that tackable privacy screens may not be added to a desk when modesty panels are in use because the screen mounting brackets interfere with the modesty panel location
- Screens 35" and narrower include two mounting brackets
- Screens 41" and wider include three mounting brackets
- Privacy screen widths may be matched to that of the corresponding work surface size
- Screens measure one inch less than the work surface widths to allow for even spacing between screens, wire management, and cornering applications

H	D	W	Pkg Wt	Pkg Cube	Product #	Price
20-3/4	1	23	9 lb	.6 ft	PSR 24 ?	\$454
20-3/4	1	29	10 lb	.8 ft	PSR 30 ?	\$510
20-3/4	1	35	11 lb	.9 ft	PSR 36 ?	\$561
20-3/4	1	41	13 lb	1.0 ft	PSR 42 ?	\$610
20-3/4	1	47	14 lb	1.2 ft	PSR 48 ?	\$645
20-3/4	1	59	17 lb	1.5 ft	PSR 60 ?	\$804
20-3/4	1	65	18 lb	1.6 ft	PSR 66 ?	\$846
20-3/4	1	71	19 lb	1.8 ft	PSR 72 ?	\$922

H	D	W	Pkg Wt	Pkg Cube	Product #	Price
11	1	23	7 lb	.6 ft	SPR 24 ?	\$387
11	1	29	8 lb	.8 ft	SPR 30 ?	\$434
11	1	35	9 lb	.9 ft	SPR 36 ?	\$476
11	1	41	11 lb	1.0 ft	SPR 42 ?	\$519
11	1	47	12 lb	1.2 ft	SPR 48 ?	\$548
11	1	59	14 lb	1.5 ft	SPR 60 ?	\$684
11	1	65	16 lb	1.6 ft	SPR 66 ?	\$718
11	1	71	19 lb	1.8 ft	SPR 72 ?	\$782

Tackable Screen - Scalloped

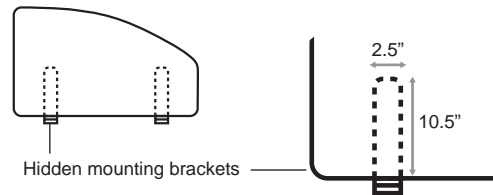

- Scalloped-shaped screen provides a "finished" look for desks positioned at the end of a run
- Available for use with 20-3/4" high rectangular screens only

H	D	W	Pkg Wt	Pkg Cube	Product #	Price
20-3/4	1	29	10 lb	.8 ft	SPSR 30 ?	\$558
20-3/4	1	35	11 lb	.8 ft	SPSR 36 ?	\$603

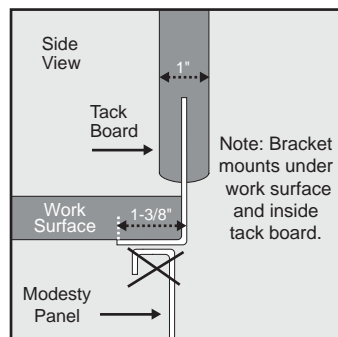

Cannot be used with modesty panels.

See page 2 for colors, laminates, fabrics

LED Linear Task Light

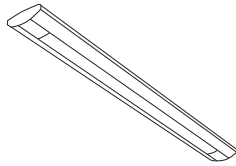

- 30" black female-male power cord
- 3500K color temperature
- Metal trough reflector with diffuser lens
- Magnetic or screw mounting options
- Clear anodized aluminum with flint color end caps, UL/CUL listed
- 3 year warranty on fixture. 1 year warranty on power supply
- 10 day lead time

For Use on	H	D	W	LEDs	Pkg Wt	Pkg Cube	Product #	Price
24" to 36" shelves	5/8	2	18-3/8	6	4 lb	2 ft	LD 618	\$465
24" to 36" shelves	5/8	2	18-3/8	9	4 lb	2 ft	LD 918	\$545
42" to 72" shelves	5/8	2	36-1/2	12	10 lb	3 ft	LD 1236	\$750
42" to 72" shelves	5/8	2	36-1/2	18	10 lb	3 ft	LD 1836	\$910

LED Green Advantages:

- Solid state technology eliminates the need for Chicago Code (fused plugs)
- Low energy consumption, No UV emissions, no flickering
- No disposal hazards - no mercury, lead, or gases
- Long life @ 50,000 hours eliminating re-lamp and maintenance time
- Allows for low profile, light weight, fixture designs

Fluorescent Task Light

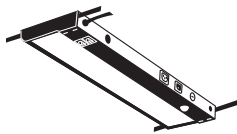

- Task light snaps in place beneath the hutch shelf with spring clips
- A 3-1/2" wide lens opening provides maximum light output
- T8 Tri-phosphor 3500K fluorescent lamp
- Includes a 9' black SJT cord
- UL and CUL listed

For Use on	H	D	W	Pkg Wt	Pkg Cube	Product #	Price
36" hutch	1-1/2	6-7/8	18-1/3	6 lb	3.1 ft	VT 18-B K	\$265
42", 48", 54" hutch	1-1/2	6-7/8	36-1/3	12 lb	6.8 ft	VT 36-B K	\$320
60", 66", 72" hutch	1-1/2	6-7/8	48-1/3	18 lb	9.1 ft	VT 48-B K	\$355

Work Surface Grommet



Field-installed grommets

- Package of ten 2-1/2" diameter round black plastic grommets for field installation
- Circular shape allows for easy installation at the work site
- These round grommets do not match the rectangular grommets that are factory-installed in desk work surfaces

Description	Pkg Wt	Pkg Cube	Product #	Price
(10) round grommets	4 lb	.6 ft	GRM 0010	\$90

See page 2 for colors, laminates, fabrics

Personal Drawer - Metal

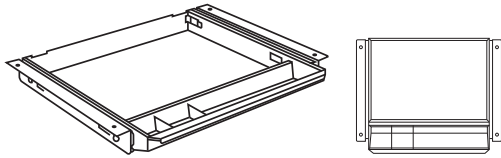

- Sleek, metal design allows the drawer to hide discretely beneath the desk
- Full extension steel ball-bearing slides
- Four integral storage compartments
- Mounts to underside of work surface using "L" brackets affixed to drawer slides
- Drawer and mounting brackets are 22 gauge steel
- Charcoal black powder coat finish
- Available with or without a lock
- Lock may also be ordered separately for later field installation

Description	H	D	W	Pkg Wt	Pkg Cube	Product #	Price
Drawer with lock	2-1/8	17	19-1/2	13 lb	1 ft	NFCX00015	\$293
Drawer only	2-1/8	17	18	13 lb	1 ft	NFC7657889	\$204
Lock only	2-1/8	1-1/2	1-1/2	1 lb	.5 ft	NFCX00020	\$89

Plastic Wire Management Channel

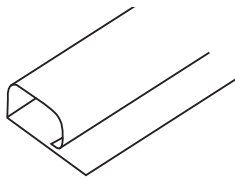

- Black plastic wire organizer channels hide tangled wires and cables. Self-adhesive backing mounts horizontally or vertically on modesty panels, end panel legs, pedestals or underside of work surfaces
- Kit includes 4 channels that are 18" long x 2-1/2" wide x 1-1/4" tall. Channels may be cut to desired length

Description	Pkg Wt	Pkg Cube	Product #	Price
(4) 18" channels	6 lb	3 ft	WMG 4018	\$55

Wire Tray

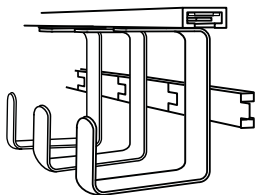

- Includes (1) 35" channel, (15) hooks, (2) endcaps, and fasteners
- Fits behind modesty panels
- Endcaps screw to bottom of work surface and secure wire tray

H	D	W	Description	Pkg Wt	Pkg Cube	Product #	Price
3-7/16	2-11/16	35	35" Under Desk Wire Tray	2 lb	.5 ft	WIR3515	\$143

Corner Wedge

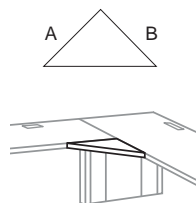

- Used in 90° desk applications to add more user desk space
- Includes two splice plates and fasteners for securing to work surface
- Center drawers cannot be mounted underneath because of splice plate placement
- Specify laminate & edge band

Description	A	B	Pkg Wt	Pkg Cube	Product #	Price
corner wedge	12"	12"	5 lb	1 ft	W1212 ?	\$280

Desk Component Note and Warranty Disclaimer:

Desk components are provided for customer convenience when creating customized desk configurations. It is exclusively the customer's responsibility to select the correct components and component sizes, and to ensure product safety and stability in the application of these components.

Please see the TRACE Desk Assembly Guide (supplied with each order) for proper placement, sequence and tools for connecting support legs, modesty panels, and work surfaces. See the TRACE Freestanding Desk FAQ's for a detailed description of the components listed here.

TRACE Panel Leg (non-handed)

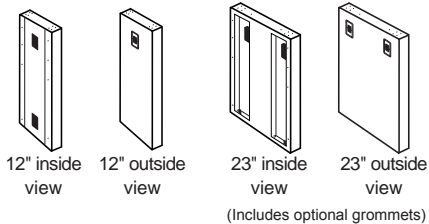

- Each 12" panel leg includes (1) 18" plastic wire management channel, (1) metal wire management cover, and a single centered grommet at the top of the leg
- Each 23" and 29" panel leg includes (1) 18" plastic wire management channel. Metal wire management covers are sold separately (see below)
- Panel legs may be ordered to include two rectangular plastic grommets, positioned at the top of the leg. Add the suffix "G" to include these grommets (no extra charge)
- Leveling glides provide 7/8" adjustment

Description	Pkg Wt	Pkg Cube	Product #	Color	* = No Grom G = Grom	Price
(1) 12" panel leg	11.5 lb	.3 ft	GOL 1201	?	?	\$258
(2) 12" panel leg	25 lb	.8 ft	GOL 1202	?	?	\$517
(1) 23" panel leg	17 lb	.6 ft	GOL 2401	?	?	\$258
(2) 23" panel leg	37 lb	1.5 ft	GOL 2402	?	?	\$517
(1) 29" panel leg	23 lb	1.1 ft	GOL 3001	?	?	\$283
(2) 29" panel leg	46 lb	2.2 ft	GOL 3002	?	?	\$568

TRACE Panel Leg Wire Management Cover

- Provides a finished look for panel leg
- For use on the 23" and 29" panel legs, two covers needed per leg.
- Covers with grommets include two grommets with edge protectors, one each located at top and bottom of each cover
- Specify with or without grommets

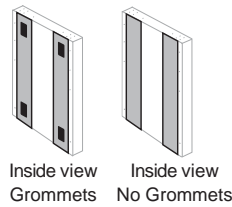

Product	Qty	Pkg Wt	Pkg Cube	Product #	Grommets	Price
panel leg cover (specify color)	pkg. of 2 covers	4 lb	.2 ft	GCV 0002 ?	Yes	\$64
	pkg. of 4 covers	8 lb	.2 ft	GCV 0004 ?	Yes	\$127
panel leg cover (specify color)	pkg. of 2 covers	4 lb	.2 ft	GCN 0002	No	\$64
	pkg. of 4 covers	8 lb	.2 ft	GCN 0004	No	\$127

TRACE Corner Leg

- Each corner leg includes (1) 18" plastic wire management channel. Corner leg wire management cover is sold separately
- Leveling glides provide 7/8" adjustment



Product	Qty	Pkg Wt	Pkg Cube	Product #	Price
corner leg (specify color)	pkg. of 1 leg	8.7 lb	1.1 ft	GOC 01 K ?	\$190

TRACE Corner Leg Wire Management Cover

- Attaches magnetically to corner leg

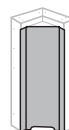

Product	Qty	Pkg Wt	Pkg Cube	Product #	Price
corner leg cover (specify color)	pkg. of 1 cover	2 lb	.2 ft	GOC 151 K ?	\$56

Panel Leg Gusset

- One gusset is required per 23" or 29" panel leg when no modesty panel or adjacent storage cabinet is present



Product	Qty	Pkg Wt	Pkg Cube	Product #	Price
gussets (specify color)	pkg. of 1 gusset	1.1 lb	.1 ft	GUS 01 K ?	\$47
	pkg. of 2 gussets	2.2 lb	.2 ft	GUS 02 K ?	\$92

See page 2 for colors, laminates, fabrics

Post Leg

- Post leg is 3" diameter and 27-3/4" high Includes leveling glide
- Pre-drilled to accommodate partial and full-height modesty panels
- Leveling glides provide 7/8" adjustment

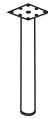

Product	Qty	Pkg Wt	Pkg Cube	Product #	Price
post leg (specify color)	pkg. of 1 leg	7 lb	.8 ft	GSK 0036 ?	\$208

"H" Leg

- For use with work surfaces 24" to 30" deep
- H leg is 27-3/4" high, with leveling glides
- Top plate is 6" x 18"
- Leg width is 16"

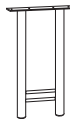

Product	Qty	Pkg Wt	Pkg Cube	Product #	Price
"h" leg (specify color)	pkg. of 1 leg	15 lb	2.0 ft	GHL 2214 ?	\$485

Splice Plate

- Connect two work surfaces at 90 degree angles to one another. 4" x 4"

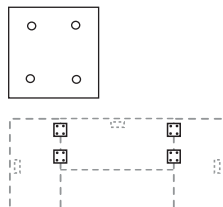

Product	Qty	Pkg Wt	Pkg Cube	Product #	Price
splice plates (black)	pkg. of 2 plates	1.1 lb	.01 ft	GSP 02 K	\$40

Modesty Panel Offset Bracket

- For use when attaching a modesty panel to the end of a panel leg, as with a return or bridge. Specify bracket for full-height or partial height modesty panel

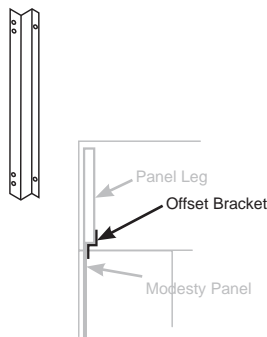

Product	Qty	Pkg Wt	Pkg Cube	Product #	Price
full-height bracket (specify color)	Pkg. of 1 bracket	2 lb	2.0 ft	MPBF 01 K ?	\$50
partial-height bracket (specify color)	Pkg. of 1 bracket	2 lb	2.0 ft	MPBH 01 K ?	\$44

Panel Leg / Pedestal Bracket

- Securely attaches pedestal to bottom of a panel leg. For use during rugged furniture rearrangement
- Bracket is black

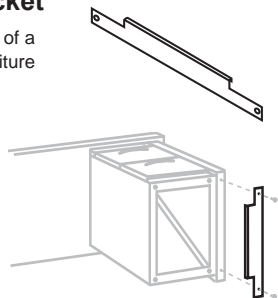



Panel leg leveling glides screw through bracket back into panel leg to secure bracket to both pedestal and leg

Product	Qty	Pkg Wt	Pkg Cube	Product #	Price
23" panel leg bracket	Pkg. of 1 bracket	.5 lb	1.0 ft	PLB 2401 K	\$38
23" panel leg bracket	Pkg. of 2 brackets	1 lb	1.0 ft	PLB 2402 K	\$76
29" panel leg bracket	Pkg. of 1 bracket	.8 lb	1.0 ft	PLB 3001 K	\$44
29" panel leg bracket	Pkg. of 2 brackets	1.6 lb	1.0 ft	PLB 3002 K	\$89

See page 2 for colors, laminates, fabrics

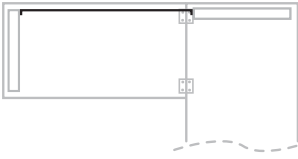
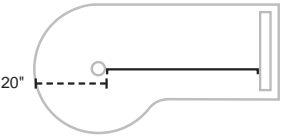
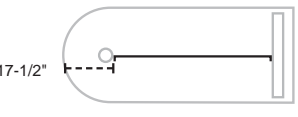
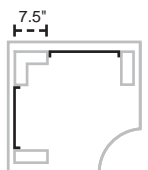
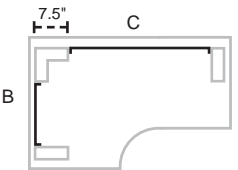
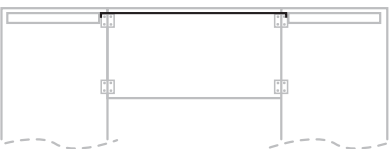
Modesty Panels All TRACE modesty panels are single piece 22 gauge metal. Pre-drilled for quick installation with any size panel leg or corner leg. Full height modesty panels are 27-5/8" high, partial height are 12" high. Plan for 1/2" work surface overhang on all sides of legs, modesty panels, and case goods. Panel legs are 1-1/2" thick. Please specify metal color.

	Desk Shells	Modesty Width	Pkg Wt	Pkg Cube	Full Height Product #	Full Ht Price	Partial Height Product #	Partial Ht Price
 <p>Desk shell modesty is 4" narrower than work surface width.</p>	30" wide	26"	9 lb	0.7 ft	GKM 2627 ?	\$151	GKM 2612 ?	\$107
	36" wide	32"	11 lb	0.8 ft	GKM 3227 ?	\$164	GKM 3212 ?	\$114
	42" wide	38"	13 lb	0.9 ft	GKM 3827 ?	\$182	GKM 3812 ?	\$120
	48" wide	44"	15 lb	1.1 ft	GKM 4427 ?	\$196	GKM 4412 ?	\$124
	54" wide	50"	17 lb	1.2 ft	GKM 5027 ?	\$208	GKM 5012 ?	\$126
	60" wide	56"	20 lb	1.4 ft	GKM 5627 ?	\$221	GKM 5612 ?	\$132
	66" wide	62"	22 lb	1.5 ft	GKM 6227 ?	\$233	GKM 6212 ?	\$139
	72" wide	68"	24 lb	1.7 ft	GKM 6827 ?	\$246	GKM 6812 ?	\$145
Return Shells and Transitional Returns								
 <p>Return modesty is 1.5" narrower than work surface width.</p>	30" wide	28.5"	10 lb	0.7 ft	GKM 2827 ?	\$157	GKM 2812 ?	\$107
	36" wide	34.5"	12 lb	0.9 ft	GKM 3427 ?	\$170	GKM 3412 ?	\$114
	42" wide	40.5"	14 lb	1.0 ft	GKM 4027 ?	\$182	GKM 4012 ?	\$120
	48" wide	46.5"	16.5 lb	1.2 ft	GKM 4627 ?	\$196	GKM 4612 ?	\$124
	60" wide	58.5"	20.5 lb	1.5 ft	GKM 5827 ?	\$217	GKM 5812 ?	\$132
	66" wide	64.5"	22.5 lb	1.6 ft	GKM 6427 ?	\$240	GKM 6412 ?	\$139
	72" wide	70.5"	25 lb	1.7 ft	GKM 7027 ?	\$252	GKM 7012 ?	\$145
"P" Peninsulas								
 <p>"P" peninsula modesty is 20" narrower than work surface width.</p>	60" wide	38"	14 lb	1.0 ft	Full Height Modesty not available		GKM 3812 ?	\$120
	66" wide	44"	16 lb	1.1 ft			GKM 4412 ?	\$124
	72" wide	50"	18 lb	1.3 ft			GKM 5012 ?	\$126
"D" Peninsulas								
 <p>"D" peninsula modesty is 17.5" narrower than work surface width.</p>	60" wide	40.5"	14 lb	1.0 ft	Full Height Modesty not available		GKM 4012 ?	\$120
	66" wide	46.5"	16 lb	1.1 ft			GKM 4612 ?	\$124
	72" wide	52.5"	18 lb	1.3 ft			GKM 5212 ?	\$126
Corner								
 <p>Corner modesty is 10" narrower than work surface width.</p>	36" wide	26"	18 lb	1.4 ft	GKM 2627 ?	\$151	GKM 2612 ?	\$107
	42" wide	32"	22 lb	1.6 ft	GKM 3227 ?	\$164	GKM 3212 ?	\$114
	48" wide	38"	26 lb	1.8 ft	GKM 3827 ?	\$182	GKM 3812 ?	\$120
Extended Corner								
 <p>Corner modesty is 10" narrower than work surface width.</p>	48" wide	38"	13 lb	0.9 ft	GKM 3827 ?	\$182	GKM 3812 ?	\$120
	60" wide	50"	17 lb	1.2 ft	GKM 5027 ?	\$208	GKM 5012 ?	\$126
	72" wide	62"	22 lb	1.5 ft	GKM 6227 ?	\$233	GKM 6212 ?	\$139
Bridge								
 <p>Bridge modesty is 1" longer than work surface width.</p>	24" wide	25"	9 lb	0.6 ft	GKM 2527 ?	\$150	GKM 2512 ?	\$107
	30" wide	31"	11 lb	0.8 ft	GKM 3127 ?	\$164	GKM 3112 ?	\$110
	36" wide	37"	13 lb	0.9 ft	GKM 3727 ?	\$176	GKM 3712 ?	\$114
	42" wide	43"	15 lb	1.1 ft	GKM 4327 ?	\$191	GKM 4312 ?	\$120
	48" wide	49"	16 lb	1.1 ft	GKM 4927 ?	\$203	GKM 4912 ?	\$126
	54" wide	55"	17 lb	1.2 ft	GKM 5527 ?	\$216	GKM 5512 ?	\$132
	60" wide	61"	21 lb	1.5 ft	GKM 6127 ?	\$229	GKM 6112 ?	\$139
	66" wide	67"	23.5 lb	1.7 ft	GKM 6727 ?	\$242	GKM 6712 ?	\$142
	72" wide	73"	25.5 lb	1.8 ft	GKM 7327 ?	\$254	GKM 7312 ?	\$145
3/4 Pedestal Desks								
 <p>3/4" pedestal desk modesty panels are all 20" high, and 4" narrower than the work surface width.</p>	60" wide	56"			One height only, to match hanging pedestal height: 19-3/8"		GKM 5620	\$221
	66" wide	62"					GKM 6220	\$233
	72" wide	68"					GKM 6820	\$246

See page 2 for colors, laminates, fabrics

Work Surface Shape	A	B	C	D	Pkg Wt	Pkg Cube	Product #	Price
Rectangular	23.5	48.0	(ped tower work surface)		39.5 lb	0.8 ft	WS 2348	\$484
	23.5	60.0	(ped tower work surface)		49.4 lb	1.0 ft	WS 2360	\$539
	24.0	24.0			20.2 lb	0.4 ft	WS 2424 G	\$377
	24.0	30.0			25.2 lb	0.5 ft	WS 2430 G	\$382
	24.0	36.0			30.2 lb	0.6 ft	WS 2436 G	\$412
	24.0	42.0			35.3 lb	0.7 ft	WS 2442 G	\$466
	24.0	48.0			40.3 lb	0.8 ft	WS 2448 G	\$471
	24.0	54.0			45.4 lb	0.9 ft	WS 2454 G	\$525
	24.0	60.0			50.4 lb	1.0 ft	WS 2460 G	\$531
	24.0	66.0			55.4 lb	1.2 ft	WS 2466 LR	\$564
	24.0	72.0			60.5 lb	1.3 ft	WS 2472 LR	\$602
	30.0	30.0			31.5 lb	0.7 ft	WS 3030 G	\$421
	30.0	36.0			37.8 lb	0.8 ft	WS 3036 G	\$456
	30.0	42.0			44.1 lb	0.9 ft	WS 3042 G	\$522
	30.0	48.0			50.4 lb	1.0 ft	WS 3048 G	\$528
	30.0	54.0			56.7 lb	1.2 ft	WS 3054 G	\$594
	30.0	60.0			63 lb	1.3 ft	WS 3060 G	\$599
	30.0	66.0			69.3 lb	1.4 ft	WS 3066 LR	\$657
	30.0	72.0			75.6 lb	1.5 ft	WS 3072 LR	\$663
	Bow Rectangular	36.0	48.0			60.5 lb	1.3 ft	WS 3648 G
	36.0	60.0			67.3 lb	1.5 ft	WS 3660 G	\$714
	36.0	66.0			83.2 lb	1.7 ft	WS 3666 LR	\$726
	36.0	72.0			90.7 lb	1.9 ft	WS 3672 LR	\$744
Bow Rectangular	30.0	72.0	36.0		90.7 lb	1.9 ft	WSB 3672 LR	\$900
Curved Corner	24.0	36.0			30.2 lb	0.6 ft	WRCR 3636	\$562
	24.0	42.0			35.3 lb	0.7 ft	WRCR 4242	\$749
	24.0	48.0			40.3 lb	0.8 ft	WRCR 4848	\$764
Straight Corner	24.0	36.0			30.2 lb	0.6 ft	WCR 3636	\$564
	24.0	42.0			35.3 lb	0.7 ft	WCR 4242	\$750
	24.0	48.0			40.3 lb	0.8 ft	WCR 4848	\$762
Extended Corner Left	24.0	48.0	60.0	24.0	76 lb	2.1 ft	EC 23602 L	\$1,133
	24.0	48.0	72.0	24.0	86 lb	2.5 ft	EC 23722 L	\$1,286
	24.0	48.0	60.0	30.0	83 lb	2.1 ft	EC 23603 L	\$1,133
	24.0	48.0	72.0	30.0	96 lb	2.5 ft	EC 23723 L	\$1,286
	30.0	48.0	60.0	24.0	81 lb	2.1 ft	EC 33602 L	\$1,133
	30.0	48.0	72.0	24.0	87 lb	2.1 ft	EC 33722 L	\$1,286
	30.0	48.0	60.0	30.0	91 lb	2.5 ft	EC 33603 L	\$1,133
	30.0	48.0	72.0	30.0	100 lb	2.5 ft	EC 33723 L	\$1,286
Extended Corner Right	24.0	48.0	60.0	24.0	76 lb	2.1 ft	EC 23602 R	\$1,133
	24.0	48.0	72.0	24.0	86 lb	2.5 ft	EC 23722 R	\$1,286
	24.0	48.0	60.0	30.0	83 lb	2.1 ft	EC 23603 R	\$1,133
	24.0	48.0	72.0	30.0	96 lb	2.5 ft	EC 23723 R	\$1,286
	30.0	48.0	60.0	24.0	81 lb	2.1 ft	EC 33602 R	\$1,133
	30.0	48.0	72.0	24.0	87 lb	2.1 ft	EC 33722 R	\$1,286
	30.0	48.0	60.0	30.0	91 lb	2.5 ft	EC 33603 R	\$1,133
	30.0	48.0	72.0	30.0	100 lb	2.5 ft	EC 33723 R	\$1,286
"D" Shaped Peninsula	23.5	48.0			39.5 lb	0.8 ft	WP 2348 LR	\$582
	23.5	60.0			49.4 lb	1.0 ft	WP 2360 LR	\$657
	30.0	60.0			63 lb	1.3 ft	WP 3060 LR	\$759
	30.0	66.0			69.3 lb	1.4 ft	WP 3066 LR	\$839
	30.0	72.0			75.6 lb	1.6 ft	WP 3072 LR	\$849
"P" Shaped Peninsula Left	30.0	60.0	36.0		73.5 lb	1.6 ft	WPL 3060 LR	\$1,033
	30.0	66.0	36.0		79 lb	1.7 ft	WPL 3066 LR	\$1,151
	30.0	72.0	36.0		85 lb	1.9 ft	WPL 3072 LR	\$1,163
"P" Shaped Peninsula Right	30.0	60.0	36.0		73.5 lb	1.6 ft	WPR 3060 LR	\$1,033
	30.0	66.0	36.0		79 lb	1.7 ft	WPR 3066 LR	\$1,151
	30.0	72.0	36.0		85 lb	1.9 ft	WPR 3072 LR	\$1,163

Note:
Rectangular tops and transitional returns include one center grommet when 60" or less, and two grommets when 66" or more in width.

Grommets are positioned 18.5" from either side and 2" from the back of the work surface to avoid interference with pedestals and hutches.

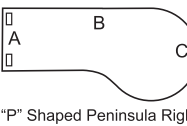
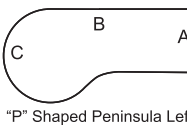
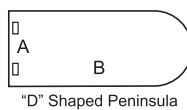
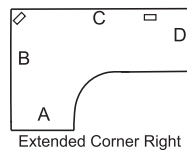
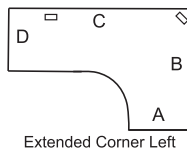
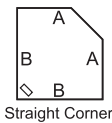
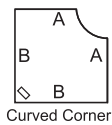
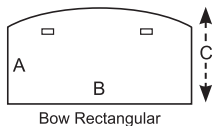
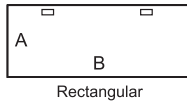

COMMERCIAL TERMS & CONDITIONS

These conditions of sale supersede all previous selling policies. Prices, discounts, lead-times and product offerings are subject to change without notice.

Order Placement

Great Openings requires that all orders be submitted in writing to avoid errors and/or duplication. Sales of all Great Openings' products are made only on the Company's standard terms and conditions of sale, unless modified in writing by an authorized Great Openings representative.

Orders received at Great Openings after 4:00pm EST will be processed the following day.

Order Acknowledgement

We diligently issue order acknowledgements via e-mail within 24 hours of purchase order receipt. If you do not receive an acknowledgement within 24 hours, please call our Customer Service department to determine the reason; we may not have received your order, or we may have questions that are delaying order entry.

**PLEASE CHECK
ACKNOWLEDGEMENTS
FOR ERRORS
IMMEDIATELY UPON RECEIPT.**

The order acknowledgement process is designed to ensure protection for both the buyer and the seller. We strongly urge the buyer to make sure the acknowledgement accurately reflects the intended purchase.

Order Discrepancies

Great Openings will not be held responsible for extra costs due to errors resulting from purchase order inaccuracies. If and when a discrepancy is detected on the purchase order or acknowledgement, all corrections must be received in writing before further order processing can occur.

Changes, Cancellations

Orders may not be changed, corrected or cancelled, in whole or in part, after Great Openings has issued its order acknowledgement without the written consent of an authorized Great Openings representative. Special order items (special or custom cabinets, Customer's Own Materials (COM) fabric and laminates) already in production are not subject to change or cancellation under any circumstances.

Canadian Orders

Canadian orders may be processed using this price book. The pricing and payment terms included in this book are in U.S. funds. Custom brokerage fees and GST/HST taxes will be charged as separate line items on the invoice. All prices are freight included; FOB: Destination. A Regional Small Order Handling Fee applies to all orders less than \$5,000 list (does not apply to accessory orders). See regional map for applicable fee.

Lead-Time

Lead-times are measured in working days, and begin after receipt of clean order.

Lead-times may change without notice. Stated lead-times will not commence until purchase order is actually entered into our system. We are not responsible for delays caused by order discrepancies or late receipt of COM items.

Special Shipping Instructions

Great Openings will accommodate special shipping/delivery requests whenever possible. Purchaser will be responsible for any and all extra costs incurred by reason of Great Openings' complying with a special shipping request. Examples of special requests that may cause extra charges (dollar amounts shown are approximate, actual amounts may vary):

- special carrier/lift gate: starting at \$85.00
- inside delivery: starting at \$50.00
- expediting, re-consignment, delays causing carrier storage: starting at \$50.00
- truck load delivery times after 3:00 pm
- delivery times outside normal business hours including weekends and holidays: starting at \$450.00 per truck
- exact, narrow scheduling window (elevator time): starting at \$150.00
- non-commercial/residential deliveries: starting at \$60.00

The maximum amount of time allowed for off-loading product from trailers is 3 hours. Carrier costs associated with any additional delivery time will be charged to the dealer. Any additional charges that result from the purchaser failing to accept a shipment as agreed upon will be the responsibility of the purchaser.

Special Delivery Charges

Once a delivery truck arrives at a destination, if the recipient is not ready to accept delivery as scheduled and the truck must wait, deliver "after hours", or make a second drop at a later time, the carrier charges a penalty for that delay which Great Openings must pass on to the customer.

These charges are as follows (dollar amounts shown are approximate, actual amounts may vary):

Night Delivery:
3:30-4:30 p.m.: \$400 additional charge
4:30-5:30 p.m.: \$450 additional charge
5:30 p.m. and later: \$500 additional charge
Detention fee will be \$75 per hour after two hours. Drop charge will be \$75 per drop.

Weekend and holiday deliveries will be quoted per load depending on location and delivery time.

Please use caution when planning and communicating delivery requirements so that these exorbitant fees will not be necessary.

Key-Alike Services

Key-alike service is offered free of charge provided the key-alike request is associated with an order for a matching quantity of

cabinets. Additional key/core sets, master and core keys are available for a nominal charge. All Great Openings products are keyed randomly prior to shipment. Special cores and keys are shipped separately to be changed-out in the field. See the Specification Guide in the front of this book.

COM & Fabric Grades

If COM materials are difficult to apply or inadequate, Great Openings reserves the right to apply extra charges or to cancel the order. Great Openings has no control over COM material quality or performance and will not be held responsible for material defects or damage caused by improper use or application.

Lifetime Warranty

Great Openings warrants its filing and storage products to be free from defects in materials and workmanship for as long as the original purchaser owns the product. This warranty does not cover ordinary wear and tear, or improper installation or use of the product. This warranty does not apply to Customer's Own Materials (COM) for fabric, laminates, or edge bands.

In addition, supplier warranties will apply to products not manufactured by Great Openings. Please contact Great Openings for more information.

Regional Pricing

Great Openings reserves the right to adopt regional discount programs and small order handling fees to address the freight cost impact applicable to each geographic region. A buyer's region will be determined by shipping destination.

Payment Terms

Orders are invoiced at the time of shipment and payment is due upon receipt of the invoice. Invoices unpaid thirty (30) days after the invoice date are subject to a late payment charge in the amount of one and one-half percent (1-1/2%) per month on the unpaid balance until paid. Great Openings reserves the right to modify or establish special credit arrangement for any customers at any time at its sole discretion. All prices are effective February 4, 2013, and are subject to change without notice.

Remit to:

**Great Openings
Dept. for Lockbox: 9521-11
PO Box 30516
Lansing, MI 48909-8016**

Taxes

All sales, use, excise and other applicable taxes (excluding only taxes on the net income of Great Openings) are the purchaser's responsibility and will be invoiced to the purchaser. If purchaser claims an exemption from such taxes, it shall be the purchaser's responsibility to furnish an appropriate exemption certificate to Great Openings.

For Canadian orders, Great Openings does invoice and collect for GST/HST.

Freight Policy

All prices are freight included - F.O.B. Destination. Prices are based on a single shipment to a single location. A Small Order Handling Fee applies to all orders less than \$5,000 list (does not apply to accessory orders):

See map below for Small Order Handling Fees by destination. For this purpose, New York City is defined as including the Bronx, Brooklyn, Manhattan, Queens, and Staten Island.

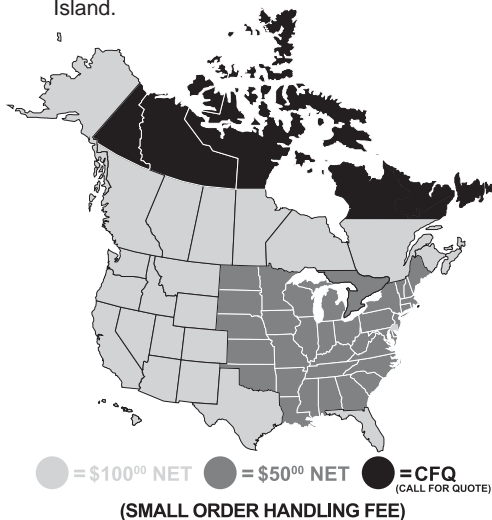

Standard Packaging

All Great Openings' products are packaged in accordance with industry standards and common carrier requirements. Pedestal products are individually boxed with polystyrene corner guard inserts, then palletized, and shrink wrapped. Lateral and storage product packaging consists of corrugated top and bottom trays, corner guards, palletized, shrink wrapped and labeled. For full truckloads only, upon special requests, we can provide a blanket wrapped shipment.

Shipment and Delivery

Freight is included in the prices as displayed in this price book. All shipments are FOB destination: free freight to destination in the continental United States. Shipments outside the contiguous 48 states will be freight collect from exit port. Exception for Canadian shipments; see the section on Canadian orders. Great Openings will select the mode and carrier of shipment.

- Partial shipments may be necessary and are at the discretion of Great Openings.
- Great Openings cannot guarantee exact time of delivery.
- Any charges resulting from late deliveries beyond our control are not the responsibility of Great Openings.
- Ship dates contained in order acknowledgements are estimated and not guaranteed.

Great Openings will often consolidate orders to maximize shipping efficiency. In these situations, a customer's designated ship date may change, though Great Openings will make every effort to ensure that requested delivery dates are still met.

Product Storage Fees

Once an order enters production, it is not possible to stop production on that order if a last-minute request is made to delay shipment. If it is absolutely necessary to hold the product at Great Openings for a later ship date, a holding fee of \$7 net per pallet or \$100 net per trailer will be assessed each week and partial week until the product ships. Weekly storage fees will be the responsibility of the purchaser on any delayed shipment of a produced order.

Returns

Great Openings will not accept returned goods.

Claim Policy

It is the purchaser's responsibility to examine goods upon receipt and to notify Great Openings customer service with any concerns. Any claims against Great Openings for apparent defects, errors or shortages must be made by the purchaser within five (5) working days after any delivery. Failure by the purchaser to make any claim against Great Openings within (5) days shall constitute acceptance of the goods and waiver of any apparent defects, errors or shortages.

Freight Damage Claims

Great Openings' terms are FOB destination, Great Openings is not responsible for damage that occurs in transit. All Great Openings' products are carefully inspected prior to shipment. The carrier signs for all goods received in apparent good order.

It is the buyer's responsibility to inspect goods upon receipt for both apparent and concealed damage. In the rare instance where shipping damage is found, we ask the purchaser NOT to refuse shipment. Accepting shipment will give us more opportunities to remedy the situation through parts (fronts, tops) replacement and within the guidelines of the stated terms.

Claim and Replacement Policy

In the case of documented shipping damage, Great Openings will file a claim with the carrier and issue at no charge any replacement parts or product only if the purchaser meets the following conditions:

- Product is shipped via a Great Openings designated carrier
- Accept the shipment
- Retain packaging
- Inspect the shipment and document damage on the bill of lading
- Contact Great Openings immediately upon discovery and documentation of damage

Failure of purchaser to meet these conditions will prevent Great Openings from obtaining carrier reimbursement and thereby require us to charge full price for product replacement.

Concealed Damage Policy

Concealed damage (damage discovered after acceptance with no bill of lading documentation) should be reported to Great Openings immediately upon discovery. Please retain packaging and request carrier inspection immediately. Carrier liability ceases 15 calendar days after receipt of shipment. Great Openings will investigate on a case-by-case basis. In any case, Great Openings assumes no liability beyond the 15-day carrier liability and reserves the right to apply no remedy and/or various remedies dictated by individual event circumstances.

The buyer may make NO DEDUCTION UNDER ANY CIRCUMSTANCES ensuing from freight claims when settling invoices with Great Openings.

Service

Please contact Great Openings with any service concerns:

Great Openings
902 E. Fourth Street
Ludington, MI 49431
Ph: 888-712-8582

GSA TERMS & CONDITIONS

- Metal filing, storage, and freestanding desk products
- Contract Number: GS-28F-0001S
- Current Contract Period: October 1, 2010 - September 30, 2015
- Great Openings/Metalworks tax ID: 38 189 8020

- FSC Schedule 71, Part 1 - Office Furniture
- Special Item Numbers (SIN) 711-2, 711-3
- Small Business Set Aside
- Certified Small and Hub Zone Company

1a) Special Item Numbers Awarded:

- SIN 711-2 Work surfaces, Workstations, Computer Furniture and Accessories
SIN 711-3 Filing and Storage Cabinets, Shelves, Mobile Carts, Dollies, Racks, and Accessories

1b) Lowest Priced Item:

- SIN 711-2 (2) Splice Plates and Fasteners
GSP 02 K (\$40.00 list)
SIN 711-3 6" Drawer Divider ECOX 1070- 1 (\$10.00 list)

2) Maximum Order:

- SIN 711-2 \$500,000 net
SIN 711-3 \$500,000 net

3) Minimum Order:

- All SIN's \$50.00

4) Geographic Coverage:

All 48 contiguous states and the District of Columbia. Port of embarkation for delivery to Alaska, Hawaii, Puerto Rico, The Virgin Islands. U.S. Government installations overseas.

5) Point of Production:

Ludington, Michigan; Manistee, Michigan

6) Discount From List Prices

69.8%

7) Tier Discounts:

Tier discounts are available, call for details.

8) Prompt Payment Terms:

Net 30 Days

9a) Government Purchase Cards - Below Micro Threshold:

Visa and MasterCard accepted

9b) Government Purchase Cards - Above Micro Threshold:

Visa and MasterCard accepted

10) Foreign Items:

None (All products are manufactured, painted and assembled in U.S.)

11a) Time of Delivery:

Shipment: When applicable, within our standard lead-time, which is noted in the Commercial Terms and Conditions.
Delivery: 30 days after receipt of order.

11b) Expedited Delivery:

Considered on a case-by-case basis.
Call Great Openings for availability and cost.

11c) Overnight and Two-Day Delivery:

Considered on a case-by-case
Call Great Openings for availability and cost.

11d) Urgent Requirements:

Considered on a case-by-case basis.
Call Great Openings for availability and cost.

12) F.O.B. Destination, Freight Prepaid and Allowed:

48 Contiguous States and Washington D.C.

For orders totaling less than \$1,000 net that are shipped to the western U.S. (including Montana, Wyoming, Colorado, New Mexico, Texas and all states west), the state of Florida, and New York City (including the Bronx, Brooklyn, Manhattan, Queens, and Staten Island), a Small Order Handling Fee of \$100 will apply. For orders totaling less than \$1,000 net that are shipped to the remainder of the U.S., a Small Order Handling Fee of \$50 will apply.

13a) Ordering Address:

Great Openings
902 E. Fourth Street
Ludington, Michigan 49431
Phone 888-712-8582
Fax 231-843-6373
www.greatopenings.com

13b) Ordering Procedures:

For supplies and services, the ordering procedures, information on Blanket Purchase Agreements (BPA's), and a sample BPA can be found in Federal Acquisition Regular (FAR) 8.405-3.

14) Payment Address:

Great Openings
P.O. Box 910
Traverse City, MI 49685-0910

15) Warranty Provision:

Lifetime Warranty
See warranty section for complete details in the Commercial Terms and Conditions.

16) Export Packaging Charges:

Quoted upon request

17) Terms And Condition of Government Purchase Card:

See item 9a + 9b. No additional discounts given.

18) Terms and Conditions of Rental, Maintenance and repair:

Not Applicable

19) Terms and Conditions of Installation:

Contact dealer or installation representative.

20) Terms and Conditions of Repair Parts:

Not Applicable

20a) Terms and Conditions for Any Other Services:

Not applicable

21) List of Service and Distribution Points:

Not Applicable

22) List of Dealers:

Please contact Great Openings for your nearest Great Openings Dealer.

23) Preventative Maintenance:

Not offered

24a) Environmental Attributes:

Has an active environmental program. Please contact Great Openings Dealer.

24b) Section 508 Electronic Compliance:

Currently not available

25) DUNS Number:

00-495-0549

26) CCR:

Great Openings is registered with the Central Contractor Registration (CCR) database. Cage Code: 33LN6

Cancellation Policy:

Orders may not be cancelled or changed without approval from Great Openings. If an order is cancelled prior to production, no cancellation charge will apply.

After production has begun, the Government will pay actual costs that the contractor can demonstrate if the product is not sold in a reasonable length of time (3 months).

Returns / Restocking Charge:

The Government will pay a 25% restocking charge.

The customer agency must obtain written authorization from Great Openings before returning any product. The customer agency will pay all return freight charges. Product returned in damaged condition will not be accepted.

DOD Requirements for Wood Packaging:

DOD's requirements (ISPM 15) for wood packaging material (WPM) are designed to block the movement of forest-destroying pests from one nation to another. Please clearly mark DOD-related purchase orders so that the required packaging can be included.



**GREAT
OPENINGS**

Speed Support Performance

**902 East 4th Street
Ludington, MI 49431
Telephone: 888-712-8582
Fax: 231-843-6373**

Web: www.greatopenings.com

E-mail: greatopeningscust.serv@greatopenings.com